



[www.klauke.com](http://www.klauke.com)

# EKM 6022ISB



Serialnumber







HE.19672\_A © 04/2019 R&D-2



Gustav Klauke GmbH • Auf dem Knapp 46 • D-42855 Remscheid • Telefon +49 2191 907 0 • [www.klauke.com](http://www.klauke.com)

# Klauke®



	Page
Before work	I - II
Bestimmungsgemäße Verwendung / Intended use	
Fehlanwendung / Misuse	III - IV
<b>SERVICE</b> 	V - VIII
 Techn. Data	IX - XI
<b>WORK</b> 	XII - XVIII
 CE DoC	XIX - XXI
 ASC 	ASC 1 - ASC 4



Wir freuen uns, dass Sie sich für ein Klauke Werkzeug entschieden haben und wünschen Ihnen viel Freude damit.

**2 Jahre  
Garantie**

**Weltweiter  
Werkzeug  
Service**

Sie haben ein Qualitätsprodukt „Made in Germany“ erworben und erhalten 2 Jahre Garantie. Diese beginnt mit dem Kaufbelegdatum.

Um lange Freude und eine einwandfreie Funktion des Werkzeuges sicherzustellen, muss das Gerät spätestens beim Erreichen von 5.000 Arbeitsvorgängen oder nach 2 Jahren durch ein Autorisiertes Service Center (ASC) gewartet werden. Wird das Wartungsintervall von 5.000 Arbeitsvorgängen nicht eingehalten, erlischt der Garantieanspruch.

Im Rahmen dieser Wartung werden verschlissene Teile ersetzt und sicherheitsrelevante Teile geprüft und ggf. vorbeugend ersetzt.

Bediener müssen zum Arbeiten an Niederspannungsanlagen autorisiert und trainiert worden sein. Alle Werkzeuge müssen in Übereinstimmung mit örtlichen Sicherheitsregeln für das Arbeiten unter Spannung betrieben werden.

Für Fragen rund um unseren Werkzeugservice oder eine Frage zu einem bestimmten Anwendungsfall stehen wir Ihnen persönlich unter der kostenlosen Hotline 0800-4685528 zur Verfügung.



Ihr Klauke Team

Thank you for choosing a Klauke tool. We hope it gives you lots of pleasure.

**2 years  
Warranty**

**World wide  
Tool  
Service**

You have purchased a quality product „Made in Germany“, which is covered by a 2 year warranty. The warranty commences from the purchase receipt date.

To ensure lasting enjoyment and a flawless tool function, the product must be serviced by an Authorised Service Center (ASC) after 5,000 operations or after 2 years. Should the service Interval exceed 5,000 cycles the warranty claim is void.

The Service includes predictive maintenance in which worn-out parts will be replaced and safety relevant parts checked/replaced.

All users must be authorized and trained for LV working. All tools must be used in accordance with local Live Line procedures.

If you have any questions about our tool service or about a specific application, please go to <http://www.klauke.com/en/service/tool-service/>



Your Klauke team



# Persönliche Schutzausrüstung Personal Protective Equipment

**PSA  
PPE**



## BEFORE WORK

Verwenden Sie PSA in Übereinstimmung mit örtlichen Arbeitsanweisungen!

Use PPE in line with local operating live working procedures!

Nur für das Arbeiten an Freileitungen!  
For overhead line working only!





**EKM 6022ISB**

**Klauke**

**BEFORE WORK**





EKM 6022ISB

Klauke

### Bestimmungsgemäße Verwendung

Intended use ✓



IEC  
60900

1000V

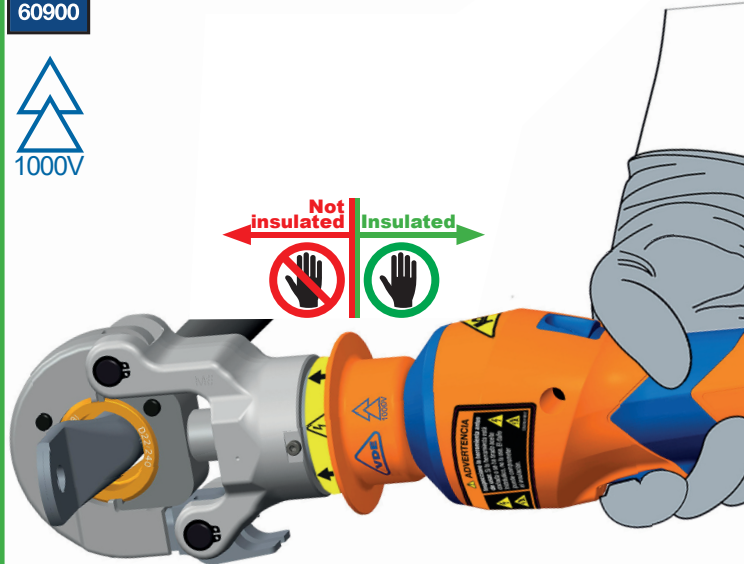

### Fehlanwendung Misuse

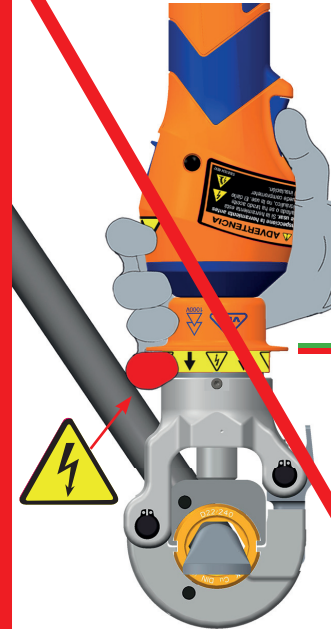

Insulated

Not insulated





 **WARNING**

Verwenden Sie Werkzeuge ausschließlich in Übereinstimmung mit firmeneigenen Arbeitsanweisungen.

Use tool always in accordance with company procedures.

 **WARNING**

Werkzeugführer müssen von der Firma für die zu verrichtende Arbeit autorisiert sein.

Users must be authorized for the work they do by the company.

 **WARNING**

Allgemeine Regel: Behandeln Sie alle Kabel als wären Sie unter Spannung.

General rule: Always treat all cable as being live.

 **WARNING**

Kein ATEX Werkzeug

No ATEX tool





EKM 6022ISB

Klauke

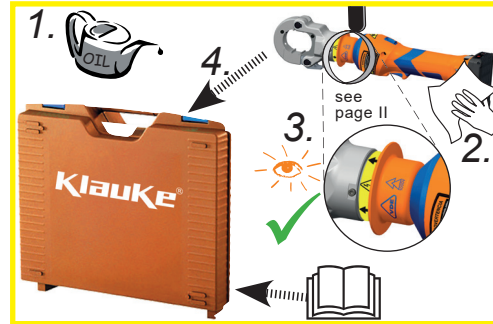

**! WARNING**

Read all safety warnings, instructions, illustrations and specifications provided with this power tool.

*Failure to follow all instructions listed below may result in electric shock, fire and/or serious injury.*

Save all warnings and instructions for future reference.







1			
2			
		Error code	*1
3a		Bluetooth (if connected) Battery charging level Current pressure Pressure max.	*2
3b		to change: bar / psi bar / psi	
3c		to change: bar / psi bar / psi	
3b		to change: kN / lbf kN / lbf	
3d			
4a		Doubleclick	
4b		Singleclick enter menu	
4c		Doubleclick select	
4d		Doubleclick confirmed	
5		Cycles (until next service)	
6		Since manufacturing: operating hours Capacity # crimps	
7			













- \*1 Error codes:
- 1 Overcurrent fuse
  - 2 Overcurrent comparator
  - 3 Overheat board
  - 4 Overheat battery
  - 5 Battery empty, operation stop
  - 6 Faulty crimp motor in operation
  - 7 Faulty crimp motor not in operation
  - 8 Low battery
  - 9 Battery empty
  - 10 RTC battery low
  - 11 Tool deactivated
  - 12 Service necessary
  - 13 RTC not found
  - 14 BT unit not found
  - 16 Pressure sensor not found
  - 17 Burst pressure exceeded
  - 18 Battery temperature too low

- 1 Überstrom durch Überstromsicherung
- 2 Überstrom durch Komparator
- 3 Boardtemperatur zu hoch
- 4 Akkutemperatur zu hoch
- 5 Akkuspannung während der Operation zu gering
- 6 Fehlpressung bei laufendem Motor
- 7 Fehlpressung bei stehendem Motor
- 8 Niedrige Akkuspannung
- 9 Akku leer
- 10 RTC-Batterie leer
- 11 Werkzeug deaktiviert
- 12 Service nötig
- 13 RTC nicht verfügbar
- 14 BT-Modul nicht verfügbar
- 16 Drucksensor nicht verfügbar
- 17 Berstdruck überschritten
- 18 Akkutemperatur zu gering

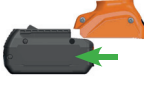
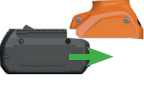
\*2 (2Hz)

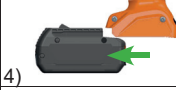
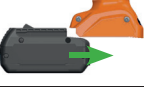



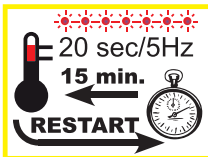







SERVICE 	DISPLAY	Wann/When/Quand/Quando/ cuándo/Wanneer/Когда/это происходит/Kiedy/quando	Warum/Why/Pourquoi/Porquê/ ¿por qué?/Waarom/Причина/ Dlaczego/Perché
 20 sec		nach Arbeitsvorgang after working cycle après opération de travail Después del proceso de trabajo após o processo de trabalho na bedrijfscyclus после цикла опрессовки po zakończeniu pracy dopo il processo di lavoro	
 20 sec/2Hz 40 x	Service Necessary	day 640 - 730 or operations 4751 - 5000	SERVICE  <b>Klauke ASC</b> Authorized Service Center
 20 sec/2Hz 40 x	Service Necessary	day 731 ... or operations 5001 ... 	 1)  2)  3) only 1 x operation   4)  5)  6) only 1 x operation  
 20 sec/5Hz		während der Übertemperatur while exceeding the temp. limit pendant surchauffe en caso de temperatura excesiva durante a temperatura excessiva tijdens te hoge temperatuur при высокой температуре внутри корпуса przy przegrzaniu superando il limite di temperatura	Werkzeug zu heiß Unit too hot outil surchauffé Herramienta demasiado caliente ferramenta demasiado quente gereedschap te heet Перегрев инструмента urządzenie za gorące Utensile troppo caldo  









SERVICE 	LED 		<b>Wann/When/Quand/Quando/ cuándo/Wanneer/Когда/это происходит/Kiedy/quando</b>	<b>Warum/Why/Pourquoi/Porquê/ ¿por qué?/Waarom/Причина/ Dlaczego/Perché</b>
 1 x	 1 x		nach Arbeitsvorgang after working cycle après opération de travail Después del proceso de trabajo após o processo de trabalho na bedrijfsscyclus после цикла опрессовки po zakończeniu pracy dopo il processo di lavoro	Fehler: der notwendige Pressdruck wurde nicht erreicht. Es handelt sich um eine manuelle Unterbrechung der Pressung bei stehendem Motor. Error: the required pressure has not been reached. The operator has interrupted the pressing cycle manually while the motor was not running. ERREUR: Pression necessaire pas atteinte. Il s'agit d'une interruption manuelle de la sertissage au moteur arrêté. Error: No se ha alcanzado la presión necesaria o el operador ha interrumpido el ciclo a mano mientras el motor ha parado. Falha: a pressão de prensagem necessária não foi alcançada. Trata-se de uma interrupção manual da prensagem com o motor parado. Foutmelding: De benodigde persdruk wordt niet bereikt. De gebruiker heeft de verkrimping handmatig stopgezet aangezien de motor niet actief is. Ошибка: не было достигнуто требуемое усилие опрессовки или оператор прервал процесс опрессовки вручную, когда двигатель остановился. Błąd: konieczne ciśnienie nie zostało osiągnięte. Użytkownik przerwał cykl pracy ręcznie w chwili, gdy silnik nie był włączony Errore: la pressione richiesta non è stata raggiunta. L'operatore ha interrotto manualmente il ciclo di pressatura mentre il motore non è in funzione.
 3 x	 3 x		nach Arbeitsvorgang after working cycle après opération de travail Después del proceso de trabajo após o processo de trabalho na bedrijfsscyclus после цикла опрессовки po zakończeniu pracy dopo il processo di lavoro	Schwerwiegender Fehler: Pressdruck wurde bei laufendem Motor nicht erreicht. Serious Error: The pressure has not been reached while the motor was running. Erreur grave: Pression pas atteinte au moteur courant. Error grave: No se ha alcanzado presión mientras el motor estaba en marcha Falha grave: a pressão de prensagem não foi alcançada com o motor em funcionamento. Urgente foutmelding: De persdruk werd bij een werkende motor niet bereikt. Серьезная ошибка: не было достигнуто требуемое усилие опрессовки во время работы двигателя Poważny błąd: konieczne ciśnienie nie zostało osiągnięte podczas pracy silnika Errore grave: la pressione non è stata raggiunta mentre il motore è in funzione.



EKM 6022ISB

Klauke

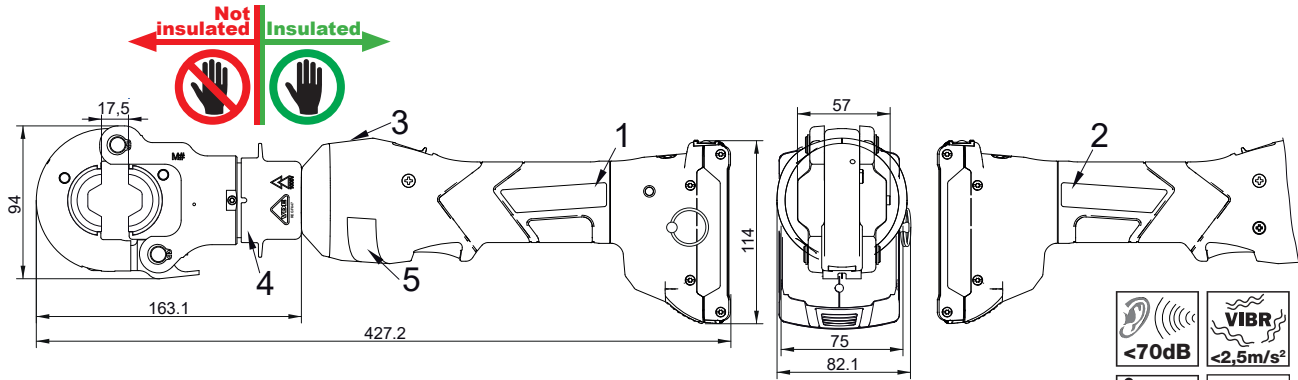

 <70dB	 <2,5m/s <sup>2</sup>
 +40°C -10°C	
 3,2 kg	 6 ton

5

⚠️ AVERTISSEMENT	⚠️ WARNING	⚠️ ADVERTENCIA
Inspecter l'outil avant chaque utilisation. Ne pas utiliser si des dégâts ou de l'huile hydraulique sont observés. Les dégâts peuvent compromettre l'isolation de l'outil.	Inspect tool before each use. Do not use if damage or hydraulic oil is observed. Damage may compromise insulation.	Inspeccione la herramienta antes de usar. Si la herramienta está dañada o se ha tirado aceite hidráulico, no la use. El daño puede comprometer el aislamiento.

52087634 REV2





EKM 6022ISB

Klauke

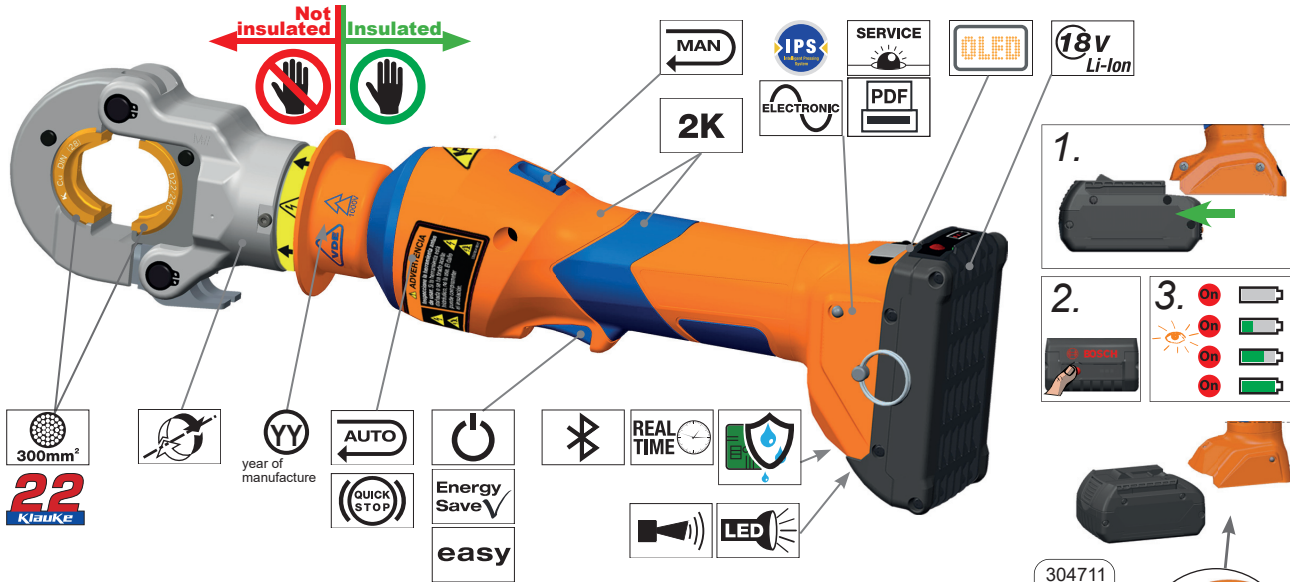

datecode

Year	Code	Month	Code	Month	Code
2022	R	Jan.	N	July	V
2023	S	Feb.	P	Aug.	W
2024	T	Mar.	Q	Sept.	X
2025	V	Apr.	R	Oct.	Y
2026	W	May	S	Nov.	Z
2027	X	June	T	Dec.	1

batch# e.g. 304711  
 datecode e.g. X = 2027; N = Jan.  
 consecutive# e.g. „142“ = tool # 142

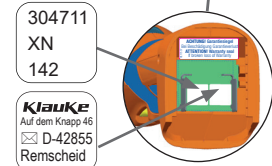



# EKM 6022ISB



Use tool only with 18 V Bosch battery

**BOSCH**  
 #1 609 92A 19R  
 #1 609 92A 0F3

**Li-ion**

Loading Full

**1.**

**2.**

**3.**

Ladegerät	GAL		GAL 1880 CV	
Sachnummer	2 607 225 ...	2 607 226 ...	2 607 225 9..	2 607 226 0..
Akku-Ladespannung (auto-matische Spannungserkennung) V $\overline{\text{=}}$	14,4 – 36		14,4 – 18	
Ladestrom A	8,0		8,0	
Zulässiger Ladetemperaturbereich °C	0 – 45		0 – 45	
Ladezeit bei Akku-Kapazität, ca.	(80%)	100%	(80%)	100%
– 1,3 Ah	min (10)	25	(10)	25
– 1,5 Ah	min (10)	25	(10)	25
– 2,0 Ah RALB1__ (36Wh)	min (15)	30	(15)	30
– 2,6 Ah	min (15)	30	(15)	30
– 3,0 Ah	min (20)	35	(20)	35
– 4,0 Ah	min (25)	35	(25)	35
– 5,0 Ah RALB2__ (90Wh)	min (35)	45	(35)	45
– 6,0 Ah	min (35)	50	(35)	50
Anzahl der Akkuzellen	4 – 30		4 – 10	
Gewicht entsprechend EPTA-Procedure 01:2014	kg	0,9		0,7
Schutzklasse	□ / II		□ / II	



Alle Bedienungsanleitungen auch unter [www.klauke.de](http://www.klauke.de) abrufbar  
All manuals are also available on [www.Klauke.com](http://www.Klauke.com)



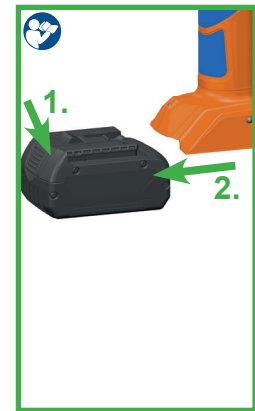
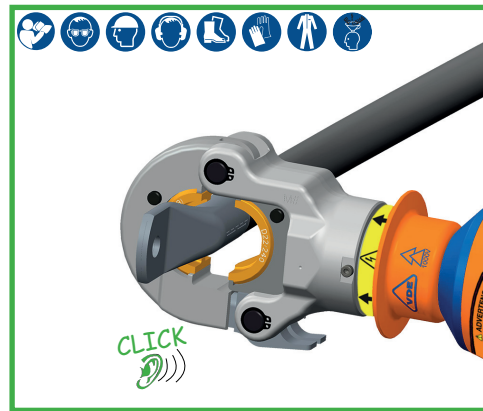
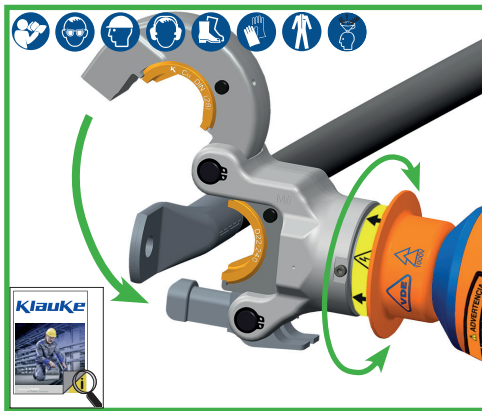
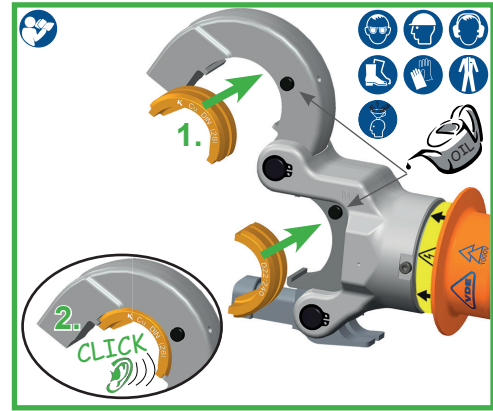
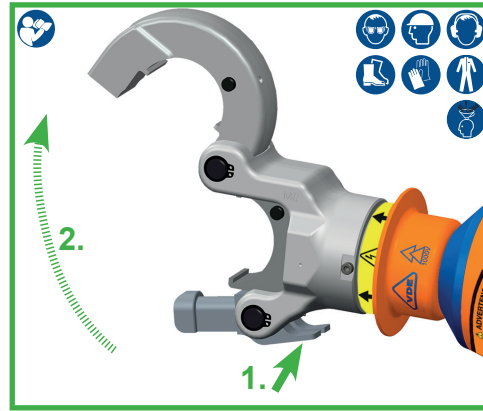

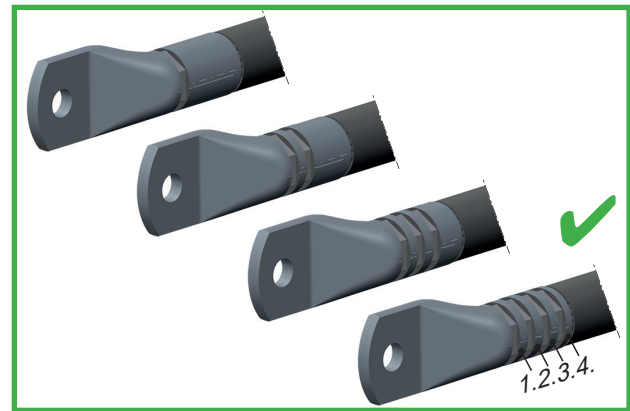
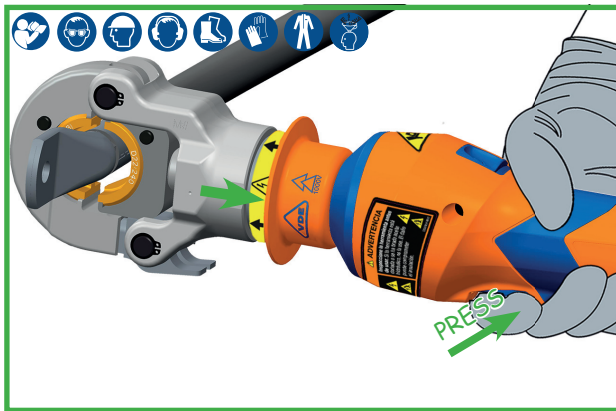
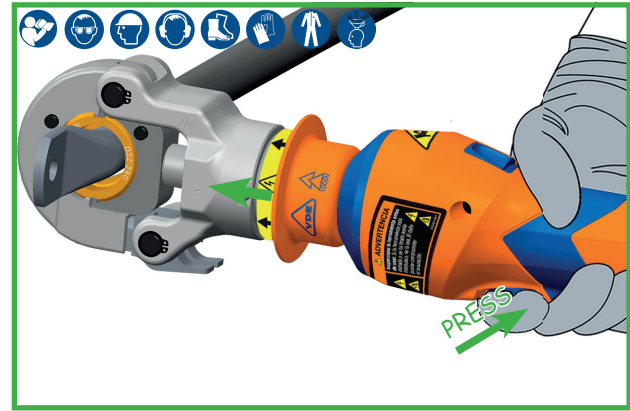
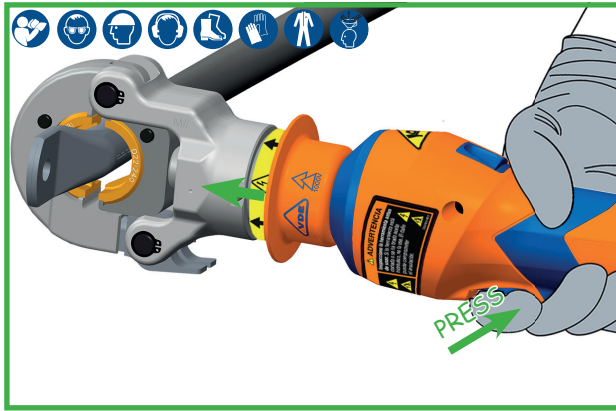



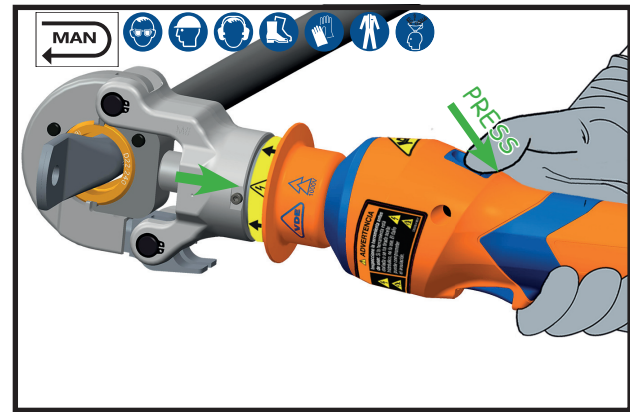
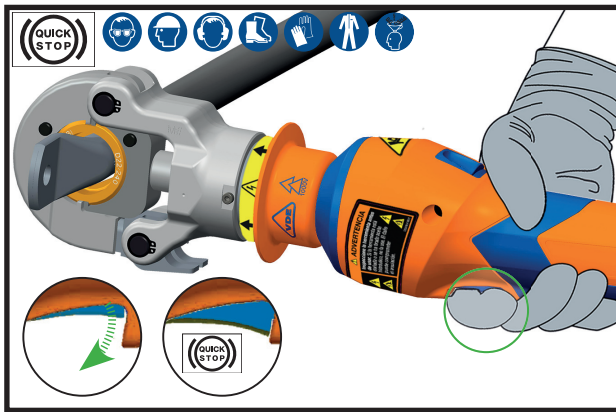
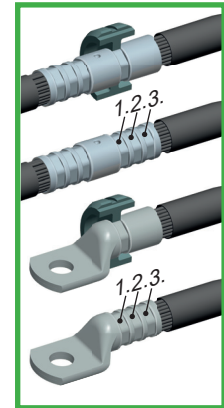
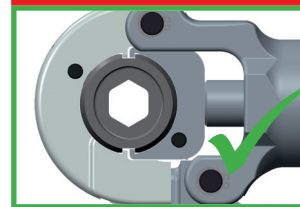
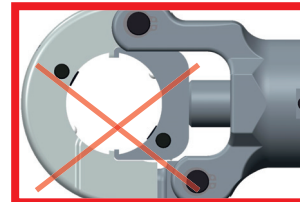
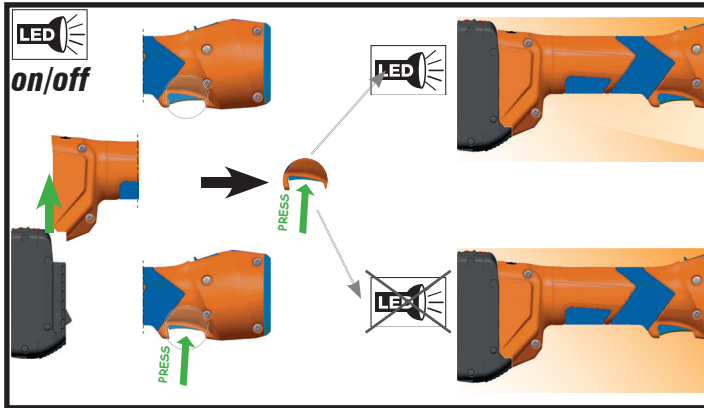



































Tab. 1

 geeignet für suitable for	Verb. material Connection material	Pressbereich mm <sup>2</sup> Crimping range mm <sup>2</sup>	Press- form Crimping mold	Kennzeichnung Marking	
				außen outside	Press- profil Profile
Rohrkabelschuhe und Verbinder - Cu (gelb chromatiert, Pressbreite 5 mm) Copper tubular cable lugs and connectors - Cu (chrome plated, crimping width 5 mm)					
Rohrkabelschuhe und Verbinder blue connection®, für verdichtete Leiter nach VDE 0295 Klasse 2 Tubular cable lugs and connectors blue connection®, for compacted conductors acc. to VDE 0295, class 2	 blue connection	6 - 300		K QS B press .... x	QS B
Rohrkabelschuhe und Verbinder „Normalausführung“, Rohrkabelschuhe für Schaltgeräteanschlüsse Tubular cable lugs and connectors, „standard type“, tubular; cable lugs for switchgear connections		6 - 300		Cu, QS	QS
Isolierte Rohrkabelschuhe und Verbinder „Normalausführung“, Isolierte Stiftkabelschuhe Insulated cable lugs and compression joints, „standard type“, insulated pin terminals		10 - 150		IS, QS	QS
Rohrkabelschuhe und Verbinder für feindrähtige Leiter Tubular cable lugs and connectors for fine stranded conductors	 	10 - 70		F, QS	QS
Rohrkabelschuhe und Verbinder für Massivleiter Tubular cable lugs and connectors for solid conductors	 	1.5 - 16			
Rohrkabelschuhe und Verbinder - Ni, VA (blau verzinkt, Pressbreite 5 mm) Tubular cable lugs and connectors, Nickel and stainless steel (blue zinc, crimping width 5 mm)					
Rohrkabelschuhe und Verbinder - Edelstahl Stainless steel tubular cable lugs and connectors - VA	 VA	0,5 - 16		Ni, QS	--
Rohrkabelschuhe und Verbinder - Ni Nickel tubular cable lugs and connectors - Ni	 Ni	10 - 50			













 geeignet für suitable for	Verb. material Connection material	Pressbereich mm <sup>2</sup> Crimping range mm <sup>2</sup>	Press- form Crimping mold	Kennzeichnung Marking	
				außen outside	Press- profil Profile
Presskabelschuhe und Verbinder nach DIN - Cu (gelb chromatiert, Pressbreite 5 mm) Compression cable lugs and connectors to DIN - Cu (chrome plated, crimping width 5 mm)					
Presskabelschuhe (DIN 46235) und Verbinder (DIN 46267, Teil 1) nach DIN - Cu Copper compression cable lugs (DIN 46235) and connectors (DIN 46267, part 1) acc. to DIN		6 - 300		Cu, QS, DIN 46235	Kennzahl
Doppelpresskabelschuhe Double-copper compression cable lugs		2 x 50 - 2 x 70		DP, QS	QS
Quetschkabelschuhe, Verbinder und Stiftkabelschuhe nach DIN - Cu (gelb chromatiert, Pressbreite 5 mm) Solderless terminals, connectors and pin terminals to DIN - Cu (chrome plated, crimping width 5 mm)					
Quetschkabelschuhe (DIN 46234), Verbinder (DIN 46341) und Stiftkabelschuhe (DIN 46230) nach DIN - Cu Solderless terminals (DIN 46234), connectors (DIN 46341) and pin terminals (DIN 46230) to DIN		10 - 70		Cu, QS, DIN 46234	QS
Isolierte Quetschkabelschuhe Insulated solderless terminals		10 - 70			ISQ, QS
Hülsen für verdichtete Leiter und Sektorleiter - Cu (gelb chromatiert, Pressbreite 5 mm) Sleeves for compacted conductors and sector shaped conductors - Cu (chrome plated, crimping width 5 mm)					
Runddrückeinsätze für Al- und Cu-Sektorleiter Pre-rounding dies for sector-shaped Al and Cu conductors		10sm - 300se/240sm		RU, QS, sm, QS, sm	--



 geeignet für suitable for	Verb. material Connection material	Pressbereich mm <sup>2</sup> Crimping range mm <sup>2</sup>	Pressform Crimping mold	Kennzeichnung Marking	
				außen outside	Pressprofil Profile
Presskabelschuhe und Verbinder nach DIN - Al (blau verzinkt, Pressbreite 7 mm) Compression cable lugs and connectors to DIN - Al (blue zinc, crimping width 7 mm)					
Presskabelschuhe und Verbinder nach DIN - Al Aluminium compression cable lugs and connectors to DIN - Al	 Al	10 - 300		Al, QS	Kennzahl
Pressverbinder für zugfeste Verbindungen von Aldrey-Seilen nach DIN EN 50182, Al-Leiter DIN EN 50182, 120-185 mm <sup>2</sup> Compression joints for full-tension connections of Aldrey conductors acc. to DIN EN 50182, Al-conductors DIN EN 50182, 120-185 mm <sup>2</sup>	 Aldrey	25 - 185			
Pressverbinder nach DIN 48085, Teil 3 für Al-Seile DIN EN 50182 Compression joints to DIN 48085, part 3 for Al-cables DIN EN 50182	 Al/St	25 / 4-120 / 20			
Presskabelschuhe und Verbinder - Al/Cu Compression cable lugs and connectors - Al/Cu					
Presskabelschuhe und Verbinder - Al/Cu Compression cable lugs and connectors - Al/Cu	 Al/Cu	10-300			



 geeignet für suitable for	Verb. material Connection material	Pressbereich mm <sup>2</sup> Crimping range mm <sup>2</sup>	Press- form Crimping mold	Kennzeichnung Marking	
				außen outside	Press- profil Profile
Klemmen und Schraubverbinder (gelb chromatiert, Pressbreite 5 mm) Clamps and screw connectors (chrome plated, crimping width 5 mm)					
Abzweigklemmen C-Form C-clamps		4 - 50		C, QS	--
Abzweigklemmen H-Form H-clamps		70			
Aderendhülsen (gelb chromatiert) Cable end-sleeves (chrome plated)					
Aderendhülsen Cable end-sleeves		10 - 240		AE, QS	--
Zwillings-Aderendhülsen Twin cable end-sleeves		2 x 4 - 2 x 16		AE, 2xQS	--
Aderendhülsen, für ausgedünnte feindrähtige Leiter Cable end sleeves, for fine stranded conductors		10 - 240		AE, QS	--
Zwillings-Aderendhülsen, für ausgedünnte feindrähtige Leiter Twin cable end sleeves, for fine stranded conductors		2 x 4 - 2 x 16		AE, QS	--

QS = Querschnitt/Cross-section; IS = isolierte Rohrkabelschuhe/ pre-insulated tubular cable lugs;

F = feindrähtige Leiter/ compacted fine str. conductors; ISQ = isolierte Quetschkabelschuhe/ pre-insulated tubular cable lugs;

RU = Rundrückeinsätze/ pre-rounding dies; sm = Sektorleiter mehrdrähtig/ multistranded conductors; AE = Aderendhülsen/ wire ferrules

K = Klauke; B = blue connection

Bitte beachten Sie bei der Verpressung von Verbindern die Einschränkungen im technischen Anhang unseres Kataloges!

Please observe the restrictions in the technical index of our catalogue when crimping connectors!

# Handgeführtes batteriebetriebenes Elektrowerkzeug Typ EKM 6022ISB

**Klauke**

**(D)** CE-19 - Konformitätserklärung. Wir erklären in alleiniger Verantwortlichkeit, daß dieses Produkt mit den folgenden Normen oder normativen Dokumenten übereinstimmt: EN 62841-1, EN ISO 12100, EN ISO 13857, EN ISO 13854, EN 28662-1, EN 61000-6-3, EN 61000-6-2, EN 60529, EN 1037 gemäß den Bestimmungen der Richtlinien 2006/42/EG, 2014/30/EU, 2011/65/EU

**(GB)** CE-19 - Declaration of conformity. We declare under our sole responsibility that this product is in conformity with the following standards or normative documents: EN 62841-1, EN ISO 12100, EN ISO 13857, EN ISO 13854, EN 28662-1, EN 61000-6-3, EN 61000-6-2, EN 60529, EN 1037 in accordance with the regulations of directives 2006/42/EG, 2014/30/EU, 2011/65/EU

**(F)** CE-19 - Déclaration de conformité. Nous déclarons sous notre seule responsabilité que ce produit est en conformité avec les normes ou documents normatifs suivants: EN 62841-1, EN ISO 12100, EN ISO 13857, EN ISO 13854, EN 28662-1, EN 61000-6-3, EN 61000-6-2, EN 60529, EN 1037 conformément aux réglementations des directives 2006/42/EG, 2014/30/EU, 2011/65/EU

**(E)** CE-19 - Declaración de conformidad. Declaramos bajo nuestra sola responsabilidad que este producto está en conformidad con las normas o documentos normativos siguientes: EN 62841-1, EN ISO 12100, EN ISO 13857, EN ISO 13854, EN 28662-1, EN 61000-6-3, EN 61000-6-2, EN 60529, EN 1037 de acuerdo con las regulaciones de las directivas 2006/42/EG, 2014/30/EU, 2011/65/EU

**(I)** CE-19 - Dichiarazione di conformità. Dichiariamo sotto la nostra esclusiva responsabilità che questo prodotto è conforme alle seguenti norme e documenti normativi: EN 62841-1, EN ISO 12100, EN ISO 13857, EN ISO 13854, EN 28662-1, EN 61000-6-3, EN 61000-6-2, EN 60529, EN 1037 conformemente alle disposizioni delle direttive 2006/42/EG, 2014/30/EU, 2011/65/EU

**(P)** CE-19 - Declaração de conformidade. Declaramos sob nossa exclusiva responsabilidade que este produto cumpre as seguintes normas ou documentos normativos: EN 62841-1, EN ISO 12100, EN ISO 13857, EN ISO 13854, EN 28662-1, EN 61000-6-3, EN 61000-6-2, EN 60529, EN 1037 conforme as disposições das directivas 2006/42/EG, 2014/30/EU, 2011/65/EU

**(NL)** CE-19 - Konformiteitsverklaring. Wij verklaren en wij stellen ons er alleen voor verantwoordelijk dat dit product voldoet aan de volgende normen of normatieve documenten: EN 62841-1, EN ISO 12100, EN ISO 13857, EN ISO 13854, EN 28662-1, EN 61000-6-3, EN 61000-6-2, EN 60529, EN 1037 overeenkomstig de bepalingen van de richtlijnen 2006/42/EG, 2014/30/EU, 2011/65/EU

**(GR)** CE-19 - ΔΗΛΩΣΗ ΣΥΜΜΟΡΦΩΣΗΣ Με αναληψη συλλογικης δηλωνομε: οτι το πορον προιον συμφωρει με τα παρακατω ποστυπα και με τα ηρωτηα ηου αναφερονται στα σχετικα εγγραφα EN 62841-1, EN ISO 12100, EN ISO 13857, EN ISO 13854, EN 28662-1, EN 61000-6-3, EN 61000-6-2, EN 60529, EN 1037 συμφωνα με τοχς κοινοισμους 2006/42/EG, 2014/30/EU, 2011/65/EU

**(S)** CE-19 - Konformitetsdeklaration. Vi förklarar på eget ansvar att denna produkt överensstämmer med följande normer eller normativa dokument: EN 62841-1, EN ISO 12100, EN ISO 13857, EN ISO 13854, EN 28662-1, EN 61000-6-3, EN 61000-6-2, EN 60529, EN 1037 enligt bestämmelserna i direktiverna 2006/42/EG, 2014/30/EU, 2011/65/EU

**(DK)** CE-19 - Konformitetserklæring. Vi erklærer under almindeligt ansvar at dette produkt er i overensstemmelse med følgende normer eller normative dokumenter: EN 62841-1, EN ISO 12100, EN ISO 13857, EN ISO 13854, EN 28662-1, EN 61000-6-3, EN 61000-6-2, EN 60529, EN 1037 i henhold til bestemmelserne i direktiverne 2006/42/EØF, 2014/30/EU, 2011/65/EU

**(N)** CE-19 - Konformitetserklæring. Vi erklærer på eget ansvar at dette produkt er i overensstemmelse med følgende standarder eller standard-dokumenter: EN 62841-1, EN ISO 12100, EN ISO 13857, EN ISO 13854, EN 28662-1, EN 61000-6-3, EN 61000-6-2, EN 60529, EN 1037 i henhold til bestemmelserne i direktive ne 2006/42/EØF, 2014/30/EU, 2011/65/EU

**(FIN)** CE-19 - Todistus standardinmukaissuudesta. Asiaa vastaavana todistamme täten, että tämä tuote on seuraavien standardien ja standardoimisasiakirjojen vaatimusten mukainen: EN 62841-1, EN ISO 12100, EN ISO 13857, EN ISO 13854, EN 28662-1, EN 61000-6-3, EN 61000-6-2, EN 60529, EN 1037 ja vastaa säädöksiä 2006/42/EG, 2014/30/EU, 2011/65/EU

**(SK)** CE-19 - Prehlásenie o zhode. Prehlasujeme na vlastnú zodpovednosť, že tieto produkty sú v súlade s nasledovnými normami: EN 62841-1, EN ISO 12100, EN ISO 13857, EN ISO 13854, EN 28662-1, EN 61000-6-3, EN 61000-6-2, EN 60529, EN 1037 a v zhode so smernicami 2006/42/EG, 2014/30/EU, 2011/65/EU

**(PL)** CE-19 - Zgodność z dyrektywami CE. Świadomy odpowiedzialności oświadczamy, że niniejszy produkt jest zgodny z następującymi normami lub dokumentacją normatywną: EN 62841-1, EN ISO 12100, EN ISO 13857, EN ISO 13854, EN 28662-1, EN 61000-6-3, EN 61000-6-2, EN 60529, EN 1037 zgodnie z postanowieniami wytycznych 2006/42/EG, 2014/30/EU, 2011/65/EU

**(CZ)** CE-19 - Prohlášení o shodě. Prohlasujeme na vlastní zodpovědnost, že tyto produkty splňují následující normy nebo normativní listiny: EN 62841-1, EN ISO 12100, EN ISO 13857, EN ISO 13854, EN 28662-1, EN 61000-6-3, EN 61000-6-2, EN 60529, EN 1037; Ve shodě se směrnicemi 2006/42/EG, 2014/30/EU, 2011/65/EU

**(SLO)** CE-19 - Izjava o skladnosti. S tem potrjujemo splošno odgovornost, da je ta izdelek narejen v skladu z navedenimi normami in standardi: EN 62841-1, EN ISO 12100, EN ISO 13857, EN ISO 13854, EN 28662-1, EN 61000-6-3, EN 61000-6-2, EN 60529, EN 1037 ter določbami in smernicami 2006/42/EG, 2014/30/EU, 2011/65/EU

**(HR)** CE-19 - Izjava o skladnosti. Pod punom odgovornošću izjavljujemo da je proizvod naveden u naslovu ovog dokumenta sukladan sa primijenjenim normama i normativnim dokumentima : EN 62841-1, EN ISO 12100, EN ISO 13857, EN ISO 13854, EN 28662-1, EN 61000-6-3, EN 61000-6-2, EN 60529, EN 1037 u skladu sa odredbama preporuka 2006/42/EG, 2014/30/EU, 2011/65/EU

**(H)** CE-19 - Megfelelőségi nyilatkozat. Kéziműködtetésű elektromos kéziszerszámok: Teljes felelősséggel kijelentjük, hogy ezek a termékek a következő szabványokkal és irányelvekkel összhangban vannak: EN 62841-1, EN ISO 12100, EN ISO 13857, EN ISO 13854, EN 28662-1, EN 61000-6-3, EN 61000-6-2, EN 60529, EN 1037; és megfelelnek a rendeltetés szerinti 2006/42/EG, 2014/30/EU, 2011/65/EU irányelveknek.

**(RO)** CE-19 - Declarație de conformitate. Noi declarăm pe propria răspundere că acest produs este în conformitate cu următoarele norme și documente normative: EN 62841-1, EN ISO 12100, EN ISO 13857, EN ISO 13854, EN 28662-1, EN 61000-6-3, EN 61000-6-2, EN 60529, EN 1037; potrivit legislației directivei 2006/42/EG, 2014/30/EU, 2011/65/EU

Remscheid, 04.10.2021



Joh. - Christoph Schütz

Dipl.-Ing. Joh.-Christoph Schütz, CE-Representative

(D) CE-'19 - Konformitätserklärung **RED**. Wir erklären in alleiniger Verantwortlichkeit, daß dieses Produkt mit den folgenden Normen oder normativen Dokumenten übereinstimmt: EN 62368-1, EN 301489-1, EN 301489-17, EN 300328 V2.2.2, EN 62479 gemäß den Bestimmungen der Richtlinien 2014/53/EU, 2011/65/EU

(GB) CE-'19 - Declaration of conformity **RED**. We declare under our sole responsibility that this product is in conformity with the following standards or normative documents: EN 62368-1, EN 301489-1, EN 301489-17, EN 300328 V2.2.2, EN 62479 in accordance with the regulations of directives 2014/53/EU, 2011/65/EU

(F) CE-'19 - Déclaration de conformité **RED**. Nous déclarons sous notre seule responsabilité que ce produit est en conformité avec les normes ou documents normatifs suivants: EN 62368-1, EN 301489-1, EN 301489-17, EN 300328 V2.2.2, EN 62479 conformément aux réglementations des directives 2014/53/EU, 2011/65/EU

(E) CE-'19 - Declaración de conformidad **RED**. Declaramos bajo nuestra sola responsabilidad que este producto está en conformidad con las normas o documentos normativos siguientes: EN 62368-1, EN 301489-1, EN 301489-17, EN 300328 V2.2.2, EN 62479 de acuerdo con las regulaciones de las directivas 2014/53/EU, 2011/65/EU

(I) CE-'19 - Dichiarazione di conformità **RED**. Dichiariamo sotto la nostra esclusiva responsabilità che questo prodotto è conforme alle seguenti norme e documenti normativi: EN 62368-1, EN 301489-1, EN 301489-17, EN 300328 V2.2.2, EN 62479 conformemente alle disposizioni delle direttive 2014/53/EU, 2011/65/EU

(P) CE-'19 - Declaração de conformidade **RED**. Declaramos sob nossa exclusiva responsabilidade que este produto cumpre as seguintes normas ou documentos normativos: EN 62368-1, EN 301489-1, EN 301489-17, EN 300328 V2.2.2, EN 62479 conforme as disposições das directivas 2014/53/EU, 2011/65/EU

(NL) CE-'19 - Konformiteitsverklaring **RED**. Wij verklaren en wij stellen ons er alleen voor verantwoordelijk dat dit produkt voldoet aan de volgende normen of normatieve documenten: EN 62368-1, EN 301489-1, EN 301489-17, EN 300328 V2.2.2, EN 62479 overeenkomstig de bepalingen van de richtlijnen 2014/53/EU, 2011/65/EU

(GR) CE-'19 - ΔΗΛΩΣΗ ΣΥΜΜΟΡΦΩΣΗΣ Μ **RED**. ε αναληψη συνολικης δηλωσμε: οτι το πορον προιον συμφορει με τα παρακατω ποσυντα και με τα ηροτινια ηου αναφερονται στα σχετικο εγγραφα α EN 62368-1, EN 301489-1, EN 301489-17, EN 300328 V2.2.2, EN 62479 συμφωνα με τοxη κοινοσημου 2014/53/EU, 2011/65/EU

(S) CE-'19 - Konformitetsdeklaration **RED**. Vi förklarar på eget ansvar att denna produkt överensstämmer med följande normer eller normativa dokument: EN 62368-1, EN 301489-1, EN 301489-17, EN 300328 V2.2.2, EN 62479 enligt bestämmelserna i direktiverna 2014/53/EU, 2011/65/EU

(DK) CE-'19 - Konformitetserklæring **RED**. Vi erklærer under almindeligt ansvar at dette produkt er i overensstemmelse med følgende normer eller normative dokumenter: EN 62368-1, EN 301489-1, EN 301489-17, EN 300328 V2.2.2, EN 62479 i henhold til bestemmelserne i direktiverne 2014/53/EU, 2011/65/EU

(N) CE-'19 - Konformitetserklæring **RED**. Vi erklærer på eget ansvarlighet at dette produkt er i overensstemmelse med følgende standarder eller standard-dokumenter: EN 62368-1, EN 301489-1, EN 301489-17, EN 300328 V2.2.2, EN 62479 i henhold til bestemmelserne i direktive ne 2014/53/EU, 2011/65/EU

(FIN) CE-'19 - Todistus standardinmukaisuudesta **RED**. Asiasta vastaavana todistamme täten, että tämä tuote on seuraavien standardien ja standardoimisasiakirjojen vaatimusten mukainen: EN 62368-1, EN 301489-1, EN 301489-17, EN 300328 V2.2.2, EN 62479 ja vastaa säädöksiä 2014/53/EU, 2011/65/EU

(SK) CE-'19 - Prehľadzenie o zhode **RED**. Prehlasujeme na vlastnú zodpovednosť, že tieto produkty sú v súlade s nasledovnými normami: EN 62368-1, EN 301489-1, EN 301489-17, EN 300328 V2.2.2, EN 62479 a v zhode so smernicami 2014/53/EU, 2011/65/EU

(PL) CE-'19 - Zgodność z dyrektywami **RED**. Świadomi odpowiedzialności oświadczamy, że niniejszy produkt jest zgodny z następującymi normami lub dokumentacja normatywna: EN 62368-1, EN 301489-1, EN 301489-17, EN 300328 V2.2.2, EN 62479 zgodnie z postanowieniami wytycznych 2014/53/EU, 2011/65/EU

(CZ) CE-'19 - Prohlášení o shodě **RED**. Prohlašujeme na vlastní zodpovědnost, že tyto produkty splňují následující normy nebo normativní listiny: EN 62368-1, EN 301489-1, EN 301489-17, EN 300328 V2.2.2, EN 62479 Ve shodě se směrnicemi 2014/53/EU, 2011/65/EU

(SLO) CE-'19 - Izjava o skladnosti **RED**. S tem potrjujemo splošno odgovornost, da je ta izdelek narejen v skladu z navedenimi normami in standardi EN 62368-1, EN 301489-1, EN 301489-17, EN 300328 V2.2.2, EN 62479 ter dolobčami in smernicami 2014/53/EU, 2011/65/EU

(HR) CE-'19 - Izjava o sukladnosti **RED**. Pod punom odgovornošću izjavljujemo da je proizvod naveden u naslovu ovog dokumenta sukladan sa primijenjenim normama i normativnim dokumentima : EN 62368-1, EN 301489-1, EN 301489-17, EN 300328 V2.2.2, EN 62479 u skladu sa odredbama preporuka 2014/53/EU, 2011/65/EU

(H) CE-'19 - Megfelelőségi nyilatkozat **RED**. Kéziműködtetésű elektromos kéziszerszámok. Teljes felelősséggel kijelentjük, hogy ezek a termékek a következő szabványokkal és irányelvekkel összhangban vannak: EN 62368-1, EN 301489-1, EN 301489-17, EN 300328 V2.2.2, EN 62479 és megfelelnek a rendeltetés 2014/53/EU, 2011/65/EU irányelveknek.

(RO) CE-'19 - Declarație de conformitate **RED**. Noi declarăm pe propria răspundere că acest produs este în conformitate cu următoarele norme și documente normative: EN 62368-1, EN 301489-1, EN 301489-17, EN 300328 V2.2.2, EN 62479 potrivit dispozițiilor directivelor 2014/53/EU, 2011/65/EU

Remscheid, 04.10.2021

Dipl.-Ing. Joh.-Christoph Schütz, CE-Representative

# Handgeführtes batteriebetriebenes Elektrowerkzeug Typ EKM 6021SB

**(D) UKCA-19 - Konformitätserklärung.** Wir erklären in alleiniger Verantwortlichkeit, dass dieses Produkt mit den folgenden Normen oder normativen Dokumenten übereinstimmt: BS EN 62841-1, BS EN ISO 12100, BS EN ISO 13857, BS EN ISO 13854, BS EN 28662-1, BS EN 61000-6-3, BS EN 61000-6-2, BS EN 1037 gemäß den Bestimmungen der Richtlinien 2006/42/EG, 2014/30/EU, 2011/65/EU  
**RED:** BS EN IEC 62368-1, EN 301489-1, EN 301489-17, EN 300328 V2.2.2, BS EN 62479 gemäß den Bestimmungen der Richtlinien 2014/53/EU, 2011/65/EU

**(GB) UKCA-19 - Declaration of conformity.** We declare under our sole responsibility that this product is in conformity with the following standards or normative documents: BS EN 62841-1, BS EN ISO 12100, BS EN ISO 13857, BS EN ISO 13854, BS EN 28662-1, BS EN 61000-6-3, BS EN 61000-6-2, BS EN 1037 in accordance with the regulations of directives 2006/42/EG, 2014/30/EU, 2011/65/EU  
**RED:** BS EN IEC 62368-1, EN 301489-1, EN 301489-17, EN 300328 V2.2.2, BS EN 62479 in accordance with the regulations of directives 2014/53/EU, 2011/65/EU

**(F) UKCA-19 - Déclaration de conformité.** Nous déclarons sous notre seule responsabilité que ce produit est en conformité avec les normes ou documents normatifs suivants: BS EN 62841-1, BS EN ISO 12100, BS EN ISO 13857, BS EN ISO 13854, BS EN 28662-1, BS EN 61000-6-3, BS EN 61000-6-2, BS EN 1037 conformément aux réglementations des directives 2006/42/EG, 2014/30/EU, 2011/65/EU  
**RED:** BS EN IEC 62368-1, EN 301489-1, EN 301489-17, EN 300328 V2.2.2, BS EN 62479 conformément aux réglementations des directives 2014/53/EU, 2011/65/EU

**(E) UKCA-19 - Declaración de conformidad.** Declaramos bajo nuestra sola responsabilidad que este producto está en conformidad con las normas o documentos normativos siguientes: BS EN 62841-1, BS EN ISO 12100, BS EN ISO 13857, BS EN ISO 13854, BS EN 28662-1, BS EN 61000-6-3, BS EN 61000-6-2, BS EN 1037 de acuerdo con las regulaciones de las directivas 2006/42/EG, 2014/30/EU, 2011/65/EU  
**RED:** BS EN IEC 62368-1, EN 301489-1, EN 301489-17, EN 300328 V2.2.2, BS EN 62479 de acuerdo con las regulaciones de las directivas 2014/53/EU, 2011/65/EU

**(I) UKCA-19 - Dichiarazione di conformità.** Dichiariamo sotto la nostra esclusiva responsabilità che questo prodotto è conforme alle seguenti norme e documenti normativi: BS EN 62841-1, BS EN ISO 12100, BS EN ISO 13857, BS EN ISO 13854, BS EN 28662-1, BS EN 61000-6-3, BS EN 61000-6-2, BS EN 1037 conformemente alle disposizioni delle direttive 2006/42/EG, 2014/30/EU, 2011/65/EU  
**RED:** BS EN IEC 62368-1, EN 301489-1, EN 301489-17, EN 300328 V2.2.2, BS EN 62479 conformemente alle disposizioni delle direttive 2014/53/EU, 2011/65/EU

**(P) UKCA-19 - Declaração de conformidade.** Declaramos sob nossa exclusiva responsabilidade que este produto cumpre as seguintes normas ou documentos normativos: BS EN 62841-1, BS EN ISO 12100, BS EN ISO 13857, BS EN ISO 13854, BS EN 28662-1, BS EN 61000-6-3, BS EN 61000-6-2, BS EN 1037 conforme as disposições das directivas 2006/42/EG, 2014/30/EU, 2011/65/EU  
**RED:** BS EN IEC 62368-1, EN 301489-1, EN 301489-17, EN 300328 V2.2.2, BS EN 62479 conforme as disposições das directivas 2014/53/EU, 2011/65/EU

**(NL) UKCA-19 - Konformiteitsverklaring.** Wij verklaren en wij stellen ons er alleen voor verantwoordelijk dat dit product voldoet aan de volgende normen of normatieve documenten: BS EN 62841-1, BS EN ISO 12100, BS EN ISO 13857, BS EN ISO 13854, BS EN 28662-1, BS EN 61000-6-3, BS EN 61000-6-2, BS EN 1037 overeenkomstig de bepalingen van de richtlijnen 2006/42/EG, 2014/30/EU, 2011/65/EU  
**RED:** BS EN IEC 62368-1, EN 301489-1, EN 301489-17, EN 300328 V2.2.2, BS EN 62479 overeenkomstig de bepalingen van de richtlijnen 2014/53/EU, 2011/65/EU

**(GR) UKCA-19 - Δήλωση Συμμόρφωσης.** Με αναλήψη συνολικής δηλωόμενης σε πομπή προϋποθέσεων με τα παρακάτω πρότυπα και με τα προηγούμενα που αναφέρονται στα σχετικά έγγραφα: BS EN 62841-1, BS EN ISO 12100, BS EN ISO 13857, BS EN ISO 13854, BS EN 28662-1, BS EN 61000-6-3, BS EN 61000-6-2, BS EN 1037 σύμφωνα με τους κανονισμούς 2006/42/ΕΓ, 2014/30/ΕΥ, 2011/65/ΕΥ  
**RED:** BS EN IEC 62368-1, EN 301489-1, EN 301489-17, EN 300328 V2.2.2, BS EN 62479 σύμφωνα με τους κανονισμούς 2014/53/ΕΥ, 2011/65/ΕΥ

**(S) UKCA-19 - Konformitetsdeklaration.** Vi förklarar på eget ansvar att denna produkt överensstämmer med följande normer eller normativa dokument: BS EN 62841-1, BS EN ISO 12100, BS EN ISO 13857, BS EN ISO 13854, BS EN 28662-1, BS EN 61000-6-3, BS EN 61000-6-2, BS EN 1037 enligt bestämmelserna i direktiverna 2006/42/EG, 2014/30/EU, 2011/65/EU  
**RED:** BS EN IEC 62368-1, EN 301489-1, EN 301489-17, EN 300328 V2.2.2, BS EN 62479 enligt bestämmelserna i direktiverna 2014/53/EU, 2011/65/EU

**(DK) UKCA-19 - Konformitetserklæring.** Vi erklærer under almindeligt ansvar at dette produkt er i overensstemmelse med følgende normer eller normative dokumenter: BS EN 62841-1, BS EN ISO 12100, BS EN ISO 13857, BS EN ISO 13854, BS EN 28662-1, BS EN 61000-6-3, BS EN 61000-6-2, BS EN 1037 i henhold til bestemmelserne i direktivene 2006/42/EF, 2014/30/EU, 2011/65/EU  
**RED:** BS EN IEC 62368-1, EN 301489-1, EN 301489-17, EN 300328 V2.2.2, BS EN 62479 i henhold til bestemmelserne i direktivene 2014/53/EU, 2011/65/EU

**(N) UKCA-19 - Konformitetserklæring.** Vi erklærer på eget ansvarlighet at dette produkt er i overensstemmelse med følgende standarder eller standard-dokumenter: BS EN 62841-1, BS EN ISO 12100, BS EN ISO 13857, BS EN ISO 13854, BS EN 28662-1, BS EN 61000-6-3, BS EN 61000-6-2, BS EN 1037 i henhold til bestemmelserne i direktive ne 2006/42/EF, 2014/30/EU, 2011/65/EU  
**RED:** BS EN IEC 62368-1, EN 301489-1, EN 301489-17, EN 300328 V2.2.2, BS EN 62479 i henhold til bestemmelserne i direktive ne 2014/53/EU, 2011/65/EU

**(FIN) UKCA-19 - Todistus standardinmukaaisuudesta.** Asiasta vastaava todistamme lähten, että tämä tuote on seuraavien standardien ja standardomissa asiakirjojen vaatimusten mukainen: BS EN 62841-1, BS EN ISO 12100, BS EN ISO 13857, BS EN ISO 13854, BS EN 28662-1, BS EN 61000-6-3, BS EN 61000-6-2, BS EN 1037 ja vastaa sääöksia 2006/42/EG, 2014/30/EU, 2011/65/EU  
**RED:** BS EN IEC 62368-1, EN 301489-1, EN 301489-17, EN 300328 V2.2.2, BS EN 62479 ja vastaa sääöksia 2014/53/EU, 2011/65/EU

**(SK) UKCA-19 - Prehlásenie o zhode.** Prehlasujeme na vlastnú zodpovednosť, že tieto produkty sú v súlade s nasledovnými normami: BS EN 62841-1, BS EN ISO 12100, BS EN ISO 13857, BS EN ISO 13854, BS EN 28662-1, BS EN 61000-6-3, BS EN 61000-6-2, BS EN 1037 a v zhode so smernicami 2006/42/EG, 2014/30/EU, 2011/65/EU  
**RED:** BS EN IEC 62368-1, EN 301489-1, EN 301489-17, EN 300328 V2.2.2, BS EN 62479 a v zhode so smernicami 2014/53/EU, 2011/65/EU

**(PL) UKCA-19 - Zgodność z dyrektywami UKCA.** Świadcimy odpowiedzialności oświadczamy, że niniejszy produkt jest zgodny z następującymi normami lub dokumentacją normatywną: BS EN 62841-1, BS EN ISO 12100, BS EN ISO 13857, BS EN ISO 13854, BS EN 28662-1, BS EN 61000-6-3, BS EN 61000-6-2, BS EN 1037 zgodnie z postanowieniami wytycznych 2006/42/EG, 2014/30/EU, 2011/65/EU  
**RED:** BS EN IEC 62368-1, EN 301489-1, EN 301489-17, EN 300328 V2.2.2, BS EN 62479 zgodnie z postanowieniami wytycznych 2014/53/EU, 2011/65/EU

**(CZ) UKCA-19 - Prohlášení o shodě.** Prohlášíme na vlastní zodpovědnost, že tyto produkty splňují následující normy nebo normativní listiny: BS EN 62841-1, BS EN ISO 12100, BS EN ISO 13857, BS EN ISO 13854, BS EN 28662-1, BS EN 61000-6-3, BS EN 61000-6-2, BS EN 1037 ve shodě se směrnicemi 2006/42/EG, 2014/30/EU, 2011/65/EU  
**RED:** BS EN IEC 62368-1, EN 301489-1, EN 301489-17, EN 300328 V2.2.2, BS EN 62479 ve shodě se směrnicemi 2014/53/EU, 2011/65/EU

**(SLO) UKCA-19 - Izjava o skladnosti.** S tem potrjujemo splošno odgovornost, da je izdelek narejen v skladu z navedenimi normami in standardi: BS EN 62841-1, BS EN ISO 12100, BS EN ISO 13857, BS EN ISO 13854, BS EN 28662-1, BS EN 61000-6-3, BS EN 61000-6-2, BS EN 1037 ter določbami in smernicami 2006/42/EG, 2014/30/EU, 2011/65/EU  
**RED:** BS EN IEC 62368-1, EN 301489-1, EN 301489-17, EN 300328 V2.2.2, BS EN 62479 ter določbami in smernicami 2014/53/EU, 2011/65/EU

**(HR) UKCA-19 - Izjava o skladnosti.** Pod punom odgovornošću izjavujemo da je proizvod naveden u naslovu ovog dokumenta skladan sa primjenjenim normama i normativnim dokumentima: BS EN 62841-1, BS EN ISO 12100, BS EN ISO 13857, BS EN ISO 13854, BS EN 28662-1, BS EN 61000-6-3, BS EN 61000-6-2, BS EN 1037 u skladu sa odredbama preporuka 2006/42/EG, 2014/30/EU, 2011/65/EU  
**RED:** BS EN IEC 62368-1, EN 301489-1, EN 301489-17, EN 300328 V2.2.2, BS EN 62479 u skladu sa odredbama preporuka 2014/53/EU, 2011/65/EU

**(H) UKCA-19 - Megfelelősségi nyilatkozat.** Kéziműködésű elektromos kéziszerszámok: Teljes felelősséggel kijelentjük, hogy ezek a termékek a következő szabványokkal és irányelvekkel összhangban vannak: BS EN 62841-1, BS EN ISO 12100, BS EN ISO 13857, BS EN ISO 13854, BS EN 28662-1, BS EN 61000-6-3, BS EN 61000-6-2, BS EN 1037, és megfelelnek a rendelkezés szerinti 2006/42/EG, 2014/30/EU, 2011/65/EU irányelveknek.  
**RED:** BS EN IEC 62368-1, EN 301489-1, EN 301489-17, EN 300328 V2.2.2, BS EN 62479 és megfelelnek a rendelkezés szerinti 2014/53/EU, 2011/65/EU irányelveknek.

**(RO) UKCA-19 - Declarație de conformitate.** Noi declarăm pe propria răspundere că acest produs este în conformitate cu următoarele norme și documente normative: BS EN 62841-1, BS EN ISO 12100, BS EN ISO 13857, BS EN ISO 13854, BS EN 28662-1, BS EN 61000-6-3, BS EN 61000-6-2, BS EN 1037; potrivit dispozițiilor directivelor 2006/42/EG, 2014/30/EU, 2011/65/EU  
**RED:** BS EN IEC 62368-1, EN 301489-1, EN 301489-17, EN 300328 V2.2.2, BS EN 62479 potrivit dispozițiilor directivelor 2014/53/EU, 2011/65/EU



Joh. - Christoph Schütz

Dipl.-Ing. Joh. Christoph Schütz, CE-Representative