

Product catalogue 37

# Cable management systems

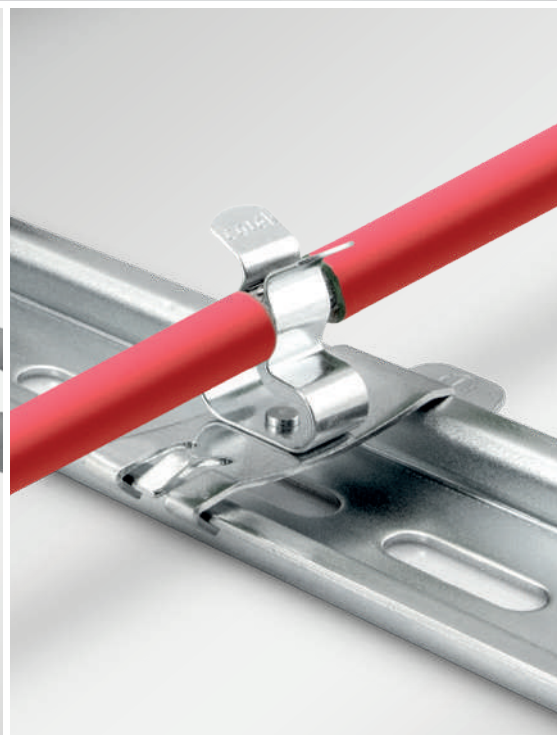

## smart cable management

Ideas move the world – under this motto we have been developing innovative cable management systems since 1995. From our headquarters in Eschach, Germany, we produce our smart cable management solutions and distribute them in more than 60 countries. We are a strong and reliable partner for the industry together with our subsidiaries in Europe, Asia and North America as well as our global representatives. Globally leading companies from various sectors rely on our know-how and our innovative strength. Numerous patents and certifications are both an incentive and aspiration for us.





Made in  
Germany

Free  
product samples

Customer  
service

No minimum  
order value













Custom  
projects





Global  
shipping







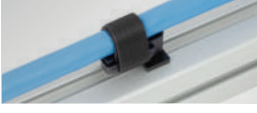



Certified  
products

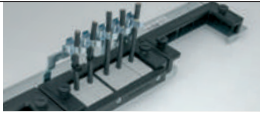

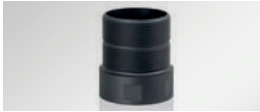
Having trouble finding a solution?  
icotek can develop a solution for  
your individual needs.

**Contact us: [pm@icotek.com](mailto:pm@icotek.com)**

<b>1.1</b> Cable entry systems for cables with connectors – KT system		<b>1.11</b> Split cable entry frames for the KT grommet system	8 – 57
		<b>1.12</b> Split cable glands for the KT grommet system	58 – 67
		<b>1.13</b> DB Distribution Box for the KT grommet system	68 – 71
		<b>1.14</b> Cable grommets and accessories for the KT system	72 – 89
		<b>1.15</b> Modular adapter system IMAS-CONNECT™ for the KT system	90 – 101
<b>1.2</b> Cable entry systems for cables with connectors – QT system		<b>1.21</b> Split cable entry frames for the QT grommet system	102 – 107
		<b>1.22</b> Split cable glands for the QT grommet system	108 – 111
		<b>1.23</b> Split plug-in cable entry plates for the QT grommet system	112 – 115
		<b>1.24</b> Cable grommets and accessories for the QT system	116 – 121
		<b>1.25</b> Modular adapter system IMAS-CONNECT™ for the QT system	122 – 133
<b>1.3</b> Cable entry systems for cables with and without connectors – UT System		<b>1.31</b> Split cable grommet in U-shape	134 – 136
		<b>1.32</b> Membrane cable grommet in U-shape	137

<b>2</b> Cable entry systems for cables without connectors		<b>2.1</b> Cable entry plate KEL-DPU	138 – 147
		<b>2.2</b> Cable entry plate KEL-DPZ, KEL-DPZ round, KEL-DPZ-CLICK	148 – 159
		<b>2.3</b> Cable entry plate KEL-DPR	160 – 161
		<b>2.4</b> Cable entry plate KEL-DP, KEL-DP round	162 – 170
		<b>2.5</b> Cable entry plate KEL-DPZ-KX/KL	172 – 173
		<b>2.6</b> Accessories for cable entry plates	171, 174
		<b>2.7</b> Cable entry plate KEL-SCDP   -TR   -RW	176 – 181
		<b>2.8</b> Flexible cable entry grommets KEL-DPF, KEL-ULTRA flex, KEL-JUMBO flex	182 – 185
<b>3</b> Strain relief and cable management		<b>3.1</b> Systems for strain relief CCL, ZL, KZL, SF ZL, DH	186 – 199
		<b>3.2</b> Systems for cable management KBH, KBH ServiceBox, KLKB, KLB	200 – 215
		<b>3.3</b> Modular stackable cable clamp MSMC	216 – 219
<b>4</b> EMC solutions Shield clamps and earthing components		<b>4.1</b> EMC solutions Shield clamps, earthing components	220 – 269
		<b>4.2</b> Split EMC cable entry frames EMV-KEL-DS, EMV-KEL	270 – 277
		<b>4.3</b> Split EMC cable glands EMV-KVT-DS	278 – 279
		<b>4.4</b> EMC grommets	280 – 281

<b>5</b> <b>CONFiX™</b> Cable conduit system and cable protection conduits		<b>5.1</b> <b>CONFiX™ Cable conduit systems</b> FWS-A, FWS-B	284 – 289
		<b>5.2</b> <b>CONFiX™ Cable protection conduits</b> WS, WST, SH	290 – 293
<b>6</b> <b>Enclosure accessories</b> Gland plates, flange plates and accessories		<b>6.1</b> <b>Gland plates and module plates</b> KDR, KDR-ESR, KDR-BMP, MP	294 – 319
		<b>6.2</b> <b>Flange plates</b> FP	320 – 329
		<b>6.3</b> <b>Blank plates</b> BPK, BPM	330 – 332
		<b>6.4</b> <b>Thread extension</b> TE-M	334 – 339
		<b>6.5</b> <b>Cable entry adapter</b> KEA	340 – 343
		<b>6.6</b> <b>Further accessories</b> for enclosures	344 – 349
<b>7</b> <b>Cable pass-through with brush seal</b> Brush plates and brush strips for enclosures, server racks, machines		<b>7.1</b> <b>Brush plate for cable pass-through</b> KEL-BES(-S), KDR-BES, FP-AX-BES	350 – 355
		<b>7.2</b> <b>Brush strips, gland plates and flange plates with brush strips</b>	356 – 367
		<b>7.3</b> <b>Brush strips for the cable management</b> in server racks	368 – 369

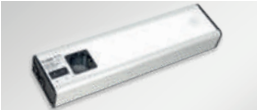
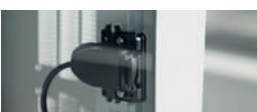
8	icotek TOOLS		8	<b>icotek TOOLS</b> Punch driver sets, rail cutters, knockout punches and useful tools	370 – 391
9	<b>Cable entry systems</b> for the railway technology		9	<b>Cable entry systems</b> with IFPS fire penetration seals acc. to EN 45545-3	392 – 395
10	<b>Cable entry systems</b> for the use in cleanrooms		10	<b>Cable entry systems</b> certified for cleanroom class 1 according to ISO 14644-1	396 – 411
11	<b>Cable entry systems</b> for the food industry		11.1	<b>Cable entry systems</b> for the food industry in signal colour blue	412 – 421
			11.11	<b>Cable grommets</b> in signal colour blue	422 – 423
			11.2	<b>Cable entry plates</b> for the food industry – Hygienic Design Line	424 – 429
			11.21	<b>Accessories</b> for Hygienic Design Line	430 – 431
12	<b>ALLIOLiGHT</b> Lighting systems for industry and automation		12.1	<b>Machine luminaire</b> TUBE	432 – 437
			12.2	<b>Enclosure luminaire</b> ALU-LINE	438 – 441
			12.3	<b>Enclosure luminaire</b> ALLIO	442 – 443
			12.4	<b>Accessories</b> for ALLIOLiGHT system luminaires	444 – 445



KEL-FA



# Cable entry systems for cables with connectors



KEL-ER/KEL-U



KEL-FG-ER



KVT-ER

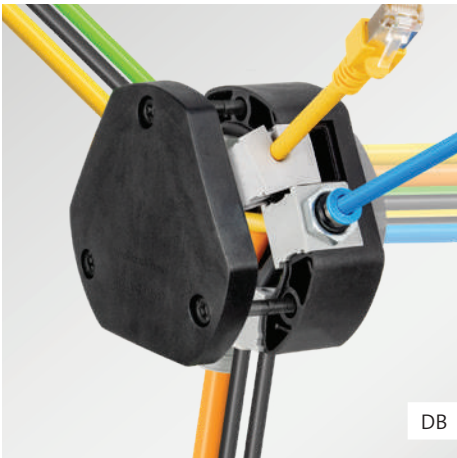

DB

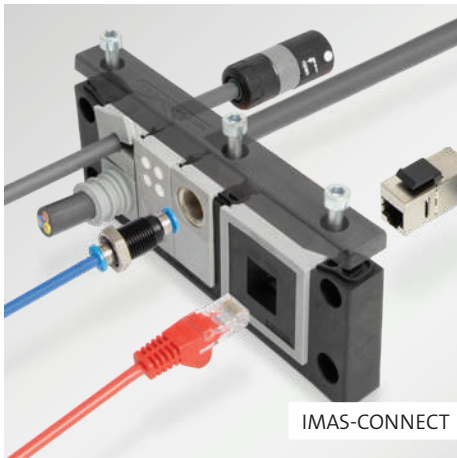

IMAS-CONNECT



KEL-QUICK

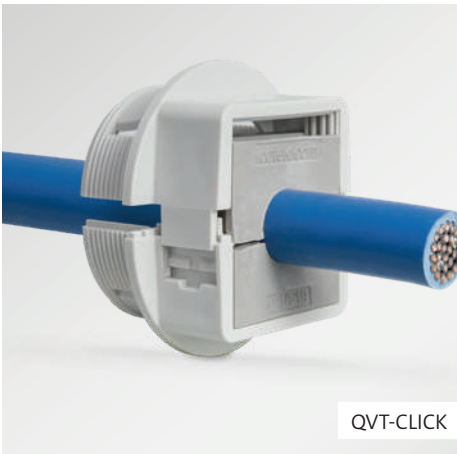

QVT-CLICK

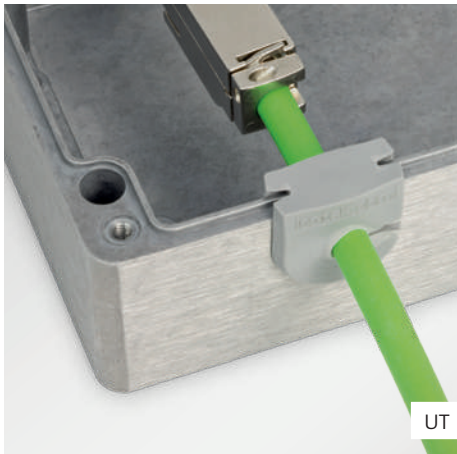

UT

Cable entry systems  
for cables with connectors

1
1.11
1.12
1.13
1.14
1.15
1.21
1.22
1.23
1.24
1.25
1.3

# 1 Cable entry systems for cables with connectors



**Product group 1 includes all split cable entry systems in round and rectangular versions. Cables with and without preassembled connectors with a maximum diameter of 75 mm can thus be inserted.**

The key features of the patented system are the split frame and split grommets which provide quick, convenient and cost effective routing of pre-terminated and multi-conductor cables, hoses and conduits. The split frame and split grommets alleviate the need to cut and re-wire pre-terminated cables. Therefore, cable warranties are unaffected.

By closing the upper and lower part of the frame a high contact pressure on the cable grommets and cables is achieved. In most cases, the cables are strain relieved according to EN 62444 and immediately sealed with IP54 to IP66/ IP68/UL type 4X (depending on type).

icotek also offers split and non-split brush plates for cable pass-through, based on rectangular and round standard cut-outs – a very cost-effective solution if sealing with IP54 is not required. See product group 7 on page 350.



All icotek products with a type rating have been tested and certified by UL according to UL 50E!  
More information about UL Type Rating vs. NEMA Rating in the appendix on page 451.



Configure your custom frames and grommets conveniently online with our Product Configurator on [www.icotek.com](http://www.icotek.com)

Single-piece packaging units are available on request.



- 1
- 1.11
- 1.12
- 1.13
- 1.14
- 1.15
- 1.21
- 1.22
- 1.23
- 1.24
- 1.25
- 1.3

Product	IP54	IP65 IP66	IP67 IP68	UL TYPE 12	UL TYPE 4X*	Strain relief	IMAS-CONNECT compatible	Cable Ø mm min   max	Max. no. of cables	Page
KEL-ER	●	●		●	●	●	●	1 – 35	10	16–19
KEL-ER-E	●	●		●		●	●	1 – 16	5	19
KEL-ER CR	●	●		●	●	●	●	1 – 35	10	402
KEL-U	●			●		●	●	1 – 35	40	20–22
KEL-U CR	●			●		●	●	1 – 35	40	403
KEL-E	●			●		●	●	1 – 16	20	23
KEL-FA	●					●	●	1 – 35	40	24–27
KEL	●			●		●	●	1 – 35	40	28–31
KEL 16/24 Extensions	●					●	●	1 – 35	120	32–37
KEL-FG-ER	●	●				●	●	1 – 35	10	42–45
KEL-FG-A/B	●			●		●	●	1 – 35	40	46–48
KEL-FG-E	●			●		●	●	1 – 16	20	49
KEL-FW	●	●				●	●	1 – 35	16	50 – 51
KEL-FL	●					●	●	1 – 16 + flat cables	13	40–41
KEL 183	●			●		●	●	1 – 75	16	38–39
KEL-SNAP(-S)	●							–	–	52 – 55
KEL-JUMBO	●			●		●	●	1 – 65	2	56 – 57
KVT-ER	●	●	●	●	●	●	●	1 – 35	4	60–61
KVT	●			●		●	●	1 – 35	16	62–63
KVT-SNAP	●					●	●	1 – 35	16	65
KVT-W90	●					●	●	1 – 35	16	66
KVT 80	●			●		●	●	1 – 35	24	64
DB	●					●	●	1 – 15	48	68 – 71
KEL-QUICK	●			●			●	1 – 29	40	105 – 107
QVT	●						●	1 – 15	16	110
QVT-CLICK	●						●	1 – 29	16	111
KEL-QTA	●							1 – 15	26	114–115
KEL-QTE	●							1 – 15	2	115
UT/UT-DT	●							3.2 – 11	5	134–137
KEL-BES / KEL-BES-S								max. 33		354–355

1  
1.11  
1.12  
1.13  
1.14  
1.15  
1.21  
1.22  
1.23  
1.24  
1.25  
1.3

\*4X for indoor use only | Further details on certifications and technical specifications can be found on the product pages.

## 1.11 Split cable entry frames for the KT grommet system

The patented cable entry system enables the user to route, seal and provide strain relief according to EN 62444 for pre-terminated cables and cables without connectors (up to 75 mm in diameter).

Electrical, pneumatic or hydraulic lines as well as corrugated conduits and hoses can be easily routed, sealed and strain relieved using split cable entry systems.

The key feature of the patented system is the split frame and split grommets which provide quick, convenient and cost effective routing of pre-terminated and multi-conductor cables, hoses and conduits. The split frame and split grommets alleviate the need to cut and re-wire pre-terminated cables. Therefore, cable warranties are unaffected.

Cables, pipes and conduits with various diameters can be routed due to a large variety of split grommets. When assembled correctly, the split grommets are held tightly within the frame. Correctly sizing the grommet to the cable diameter ensures a high degree of protection (up to IP66/UL type 4X) and provides strain relief.

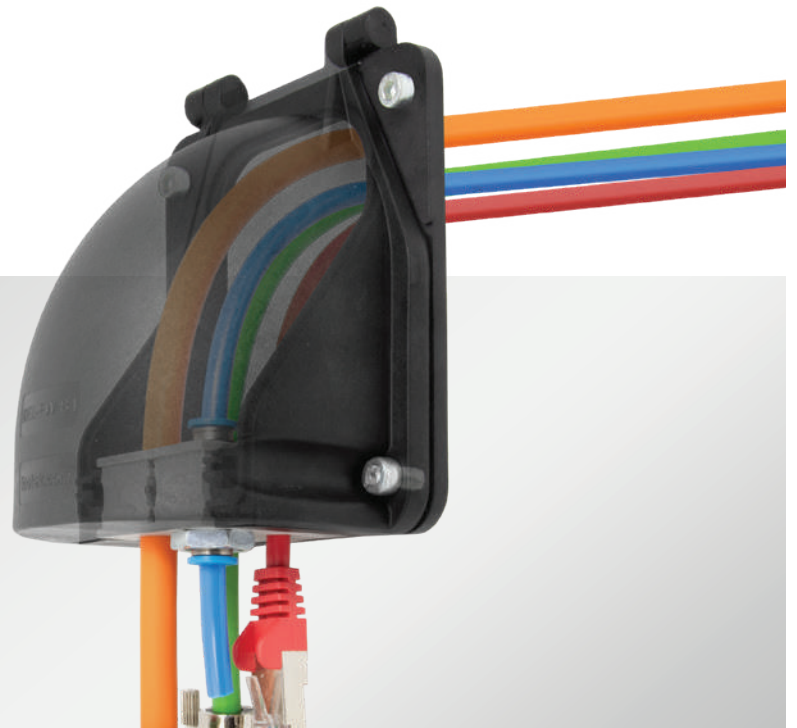

- 1
- 1.11
- 1.12
- 1.13
- 1.14
- 1.15
- 1.21
- 1.22
- 1.23
- 1.24
- 1.25
- 1.3

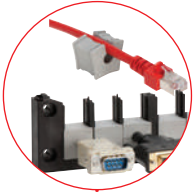

Split system



Secure and tight connection

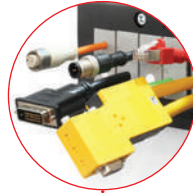

Maintain warranty on pre-terminated cables



Fast and easy assembly

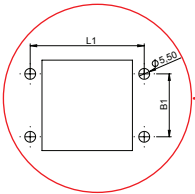

Most sizes are industrial standard cut-outs. No need for additional tooling.

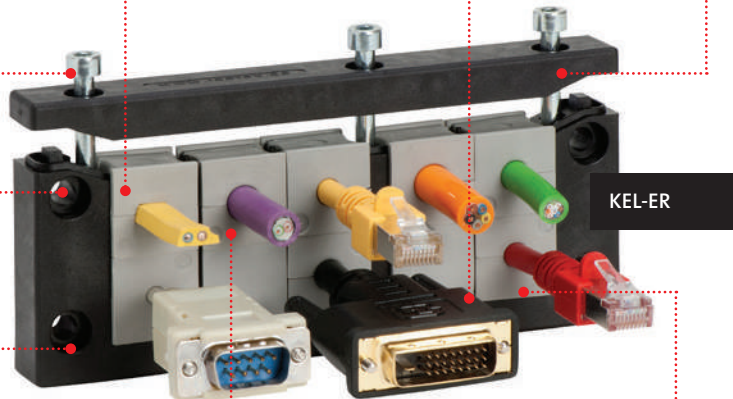

High cable density, wide variety in cable grommets and adapter grommets



Integrated strain relief according to EN 62444

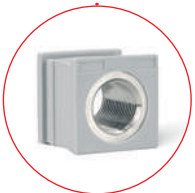

Can be combined with IMAS-CONNECT grommets

KEL-U/KEL: IP54 rated protection  
KEL-ER: IP66 due to a high clamping pressure on the cover lid and injected sealing



- 1
- 1.11
- 1.12
- 1.13
- 1.14
- 1.15
- 1.21
- 1.22
- 1.23
- 1.24
- 1.25
- 1.3

## 1.11 Split cable entry frames for the KT grommet system



Split cable entry frames for cable diameters up to 35 mm

KEL-ER series

16 – 19



Split cable entry frames for cable diameters up to 35 mm

KEL-U series / KEL-E series

20 – 23



Split cable entry frames "Fast Assembly" for a fast assembly without tools for cable diameters up to 35 mm

KEL-FA series

24 – 27



Centrally split cable entry frames for cable diameters up to 35 mm

KEL series

28 – 31



Extended split cable entry frames for cable diameters up to 35 mm

KEL series, extended

32 – 37



Split cable entry frames for cable diameters up to 75 mm

KEL 183 series / KTMB 183

38 – 39



Split cable entry frames for flat cables and round cables up to 17 mm in diameter

KEL-FL / FT

40 – 41



Split flange enclosure for 90° cable transit with integrated seal for cable diameters up to 35 mm

KEL-FG-ER series

42 – 45



Split flange enclosure for 90° cable transit for cable diameters up to 35 mm

KEL-FG series

46 – 49



Bulkhead for 90° cable transit for cable diameters up to 35 mm

KEL-FW

50 – 51



Snap mounting frames for installation of KEL-U / KEL frames, split (KEL-SNAP-S)

KEL-SNAP-S / KEL-SNAP

52 – 55



Split cable entry frames for cable diameters up to 65 mm

KEL-JUMBO / KTF

56 – 57



360° cable entry  
for cable diameters up to 15 mm

DB

68 – 71



Cable grommets  
split and not split,  
for cables with/without connectors,  
for cable diameters 1 – 35 mm

74 – 89



IMAS-CONNECT™  
Modular adapter system for the KT system

Adapter grommets /Accessories

90 – 101



Thread extension  
for cable glands and  
cable entry plates  
M32, M50, M63

TE-M

334 – 337



Split brush plate  
for cable pass-through  
for standard cut-outs

KEL-BES-S

355



Product configurator  
[www.icotek.com/en/config](http://www.icotek.com/en/config)

67

- 1
- 1.11
- 1.12
- 1.13
- 1.14
- 1.15
- 1.21
- 1.22
- 1.23
- 1.24
- 1.25
- 1.3

# KEL-ER series

## Cable entry frames with IP66 rating



Split cable entry system for routing and sealing cables with connectors, providing an IP66/UL Type 12/4X rating and strain relief for cable diameters from 1 to 17 mm (single-hole grommets KT1 to KT17) and 16 to 35 mm (single-hole grommets KT16 to KT34).

The cable entry system is easy to install. Cable grommets are placed into compartments and are securely fixed to the frame during assembly.

The KEL-ER frames match exactly the cut-out dimensions for 10-, 16- and 24-pin standard industrial connectors. Either a cut-out of 36 mm or 46 mm in height can be chosen depending on the cables being routed. The KEL-ER-B frame matches the cut-out dimensions of 46 x 46 mm measuring instruments.

The single-row versions KEL-ER-E are particularly suited for flat connectors. The small frames are ideal for applications with limited space. A flat rubber gasket is included in the shipment.

The version with threaded bushings enables the cable entry frame to be screwed onto the housing from the inside out. This protects against vandalism and tampering with the housing from the outside.

### Advantages & benefits

- Maintain manufacturer's warranty on pre-terminated cables
- Retrofittings, repairs and maintenance can be done much more easily and quickly
- High cable density, wide variety of grommets
- Strain relief according to EN 62444
- High stability, vibration resistant
- Can be combined with IMAS-CONNECT adapter grommets

### Specifications

Material	Polyamide (PA)
Flame class	UL 94 V-0, self-extinguishing
IP rating	IP66, with gasket and correct selection of single grommets (certified acc. to EN 60529)
UL type rating	UL type 4X (acc. to UL 50E)
Temperature	-40°C to +140°C (static)
Properties	Halogen-free, silicone-free
Frame depth	17 mm

### Accessories

KT Cable grommets	74 – 89
AT Adapter grommets	90 – 101
KEL-EMC Cable collectors	260 – 262
ST Plugs	85



The cable entry frames enable the integration of the IMAS-CONNECT™ adapter grommets



Also available with stainless steel screws (V2A)



Also available with threaded bushings



Split KT grommets



**i** The KEL-ER series is also available as a cleanroom version, see from page 402. Single-piece packaging units are available on request.



# KEL-ER

## Cable entry frames

### KEL-ER 24, KEL-ER 16

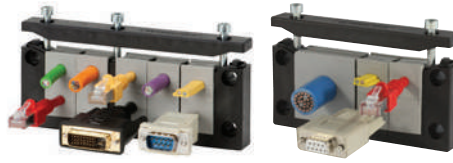

Description	Cut-out   Drilling template	Type	Cut-out mm	Grommets small   large	Order No.	PU
		KEL-ER 24 10	36/46 × 112	10   -	48241	10
		KEL-ER 24 10 with V2A screws	36/46 × 112	10   -	48241.200	10
		KEL-ER 24 10 with threaded bushings M4	36/46 × 112	10   -	48241.400	10
		KEL-ER 24 7	36/46 × 112	6   1	48247	10
		KEL-ER 24 7 with V2A screws	36/46 × 112	6   1	48247.200	10
		KEL-ER 24 7 with threaded bushings M4	36/46 × 112	6   1	48247.400	10
		KEL-ER 24 4	36/46 × 112	2   2	48244	10
		KEL-ER 24 4 with V2A screws	36/46 × 112	2   2	48244.200	10
		KEL-ER 24 4 with threaded bushings M4	36/46 × 112	2   2	48244.400	10
		KEL-ER 16 8	36/46 × 86	8   -	48168	10
		KEL-ER 16 8 with V2A screws	36/46 × 86	8   -	48168.200	10
		KEL-ER 16 8 with threaded bushings M4	36/46 × 86	8   -	48168.400	10
		KEL-ER 16 5	36/46 × 86	4   1	48165	10
		KEL-ER 16 5 with V2A screws	36/46 × 86	4   1	48165.200	10
		KEL-ER 16 5 with threaded bushings M4	36/46 × 86	4   1	48165.400	10
		KEL-ER 16 2	36/46 × 86	-   2	48162	10
		KEL-ER 16 2 with V2A screws	36/46 × 86	-   2	48162.200	10
		KEL-ER 16 2 with threaded bushings M4	36/46 × 86	-   2	48162.400	10

1  
1.11  
1.12  
1.13  
1.14  
1.15  
1.21  
1.22  
1.23  
1.24  
1.25  
1.3

# KEL-ER

## Cable entry frames

### KEL-ER 10, KEL-ER B



Description	Cut-out   Drilling template	Type	Cut-out mm	Grommets small   large	Order No.	PU
		KEL-ER 10 6	36/46 × 65	6   –	48216	10
		KEL-ER 10 6 with V2A screws	36/46 × 65	6   –	48216.200	10
		KEL-ER 10 6 with threaded bushings M4	36/46 × 65	6   –	48216.400	10
		KEL-ER 10 3	36/46 × 65	2   1	48212	10
		KEL-ER 10 3 with V2A screws	36/46 × 65	2   1	48212.200	10
		KEL-ER 10 3 with threaded bushings M4	36/46 × 65	2   1	48212.400	10
		KEL-ER-B4	46 × 46	4   –	48204	10
		KEL-ER-B4 with V2A screws	46 × 46	4   –	48204.200	10
		KEL-ER-B4 with threaded bushings M4	46 × 46	4   –	48204.400	10
		KEL-ER-B1	46 × 46	–   1	48206	10
		KEL-ER-B1 with V2A screws	46 × 46	–   1	48206.200	10
		KEL-ER-B1 with threaded bushings M4	46 × 46	–   1	48206.400	10

**i** The KEL-ER series is also available as a cleanroom version, see from page 402.  
Single-piece packaging units are available on request.

# KEL-ER

## Cable entry frames

### KEL-ER-E



Description	Cut-out   Drilling template	Type	Cut-out mm	Grommets small   large	Order No.	PU
		KEL-ER-E5	112 × 24	5   -	48250	10
		KEL-ER-E5 with V2A screws	112 × 24	5   -	48250.200	10
		KEL-ER-E5 with threaded bushings M4	112 × 24	5   -	48250.400	10
		KEL-ER-E4	112 × 24	4   -	48259	10
		KEL-ER-E4 with V2A screws	112 × 24	4   -	48259.200	10
		KEL-ER-E4 with threaded bushings M4	112 × 24	4   -	48259.400	10
		KEL-ER-E3	65 × 24	3   -	48258	10
		KEL-ER-E3 with V2A screws	65 × 24	3   -	48258.200	10
		KEL-ER-E3 with threaded bushings M4	65 × 24	3   -	48258.400	10
		KEL-ER-E2	43 × 24	2   -	48249	10
		KEL-ER-E2 with V2A screws	43 × 24	2   -	48249.200	10
		KEL-ER-E2 with threaded bushings M4	43 × 24	2   -	48249.400	10

**i** The KEL-ER series is also available as a cleanroom version, see from page 402.  
Single-piece packaging units are available on request.

- 1
- 1.11
- 1.12
- 1.13
- 1.14
- 1.15
- 1.21
- 1.22
- 1.23
- 1.24
- 1.25
- 1.3

# KEL-U series

## Cable entry frames with IP54 rating



Split cable entry system for routing cables with connectors providing an IP54/UL Type 12 rating. Routing, sealing and providing strain relief for cable diameters from 1 to 35 mm.

The cable entry system is easy to install. Cable grommets are placed into compartments and are securely fixed to the frame during assembly.

The KEL-U frames match exactly the cut-out dimensions for 10-, 16- and 24-pin standard industrial connectors. Either a cut-out of 36 mm or 46 mm in height can be chosen depending on the cables being routed. The KEL-U-B frame matches the cut-out dimensions of 46 × 46 mm measuring instruments. For tool-free assembly/disassembly of the cable entry frames the snap mounting frame KEL-SNAP can be used.

The single-row versions KEL-E are particularly suited for flat connectors. The small frames are ideal for applications with limited space. A flat rubber gasket is included in the shipment.

The version with threaded bushings enables the cable entry frame to be screwed onto the housing from the inside out. This protects against vandalism and tampering with the housing from the outside.

### Advantages & benefits

- Fast and easy assembly
- Maintain manufacturer's warranty on pre-terminated cables
- Retrofittings, repairs and maintenance can be done much more easily and quickly
- High cable density, wide variety of grommets
- Strain relief according to EN 62444
- High stability, vibration resistant
- Can be combined with IMAS-CONNECT adapter grommets

### Specifications

Material	Polyamide (PA)
Flame class	UL 94 V-0, self-extinguishing
IP rating	IP54, with gasket and correct selection of cable grommets (certified acc. to EN 60529)
UL type rating	UL type 12 (acc. to UL 50E)
Temperature	-40°C to +140°C (static)
Properties	Halogen-free, silicone-free
Frame depth	17 mm

### Accessories

KT Cable grommets	74 - 89
AT Adapter grommets	90 - 101
KEL-SNAP Mounting frames	52 - 55
KEL-EMC Cable collectors	260 - 262
KDR Base plates	300 - 313
FP Flange plates	320 - 329
ST Plugs	85



The cable entry frames enable the integration of the IMAS-CONNECT™ adapter grommets



Also available with stainless steel screws (V2A)

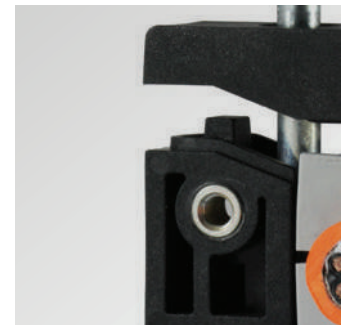

Also available with threaded bushings

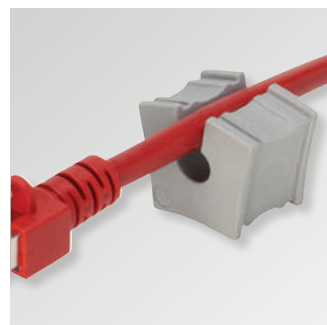

Split KT grommets



**i** The KEL-U series is also available as a cleanroom version, see from page 403. Single-piece packaging units are available on request.

# KEL-U

## Cable entry frames

### KEL-U 24, KEL-U 16



Description	Cut-out   Drilling template	Type	Cut-out dimensions mm	Grommets small   large	Order No.	PU
		KEL-U 24 10	36/46 × 112	10   -	54241	10
		KEL-U 24 10 with V2A screws	36/46 × 112	10   -	54241.200	10
		KEL-U 24 10 with threaded bushings M4	36/46 × 112	10   -	54241.400	10
		KEL-U 24 7	36/46 × 112	6   1	54247	10
		KEL-U 24 7 with V2A screws	36/46 × 112	6   1	54247.200	10
		KEL-U 24 7 with threaded bushings M4	36/46 × 112	6   1	54247.400	10
		KEL-U 24 4	36/46 × 112	2   2	54244	10
		KEL-U 24 4 with V2A screws	36/46 × 112	2   2	54244.200	10
		KEL-U 24 4 with threaded bushings M4	36/46 × 112	2   2	54244.400	10
		KEL-U 16 8	36/46 × 86	8   -	54168	10
		KEL-U 16 8 with V2A screws	36/46 × 86	8   -	54168.200	10
		KEL-U 16 8 with threaded bushings M4	36/46 × 86	8   -	54168.400	10
		KEL-U 16 5	36/46 × 86	4   1	54165	10
		KEL-U 16 5 with V2A screws	36/46 × 86	4   1	54165.200	10
		KEL-U 16 5 with threaded bushings M4	36/46 × 86	4   1	54165.400	10
		KEL-U 16 2	36/46 × 86	-   2	54162	10
		KEL-U 16 2 with V2A screws	36/46 × 86	-   2	54162.200	10
		KEL-U 16 2 with threaded bushings M4	36/46 × 86	-   2	54162.400	10

1  
1.11  
1.12  
1.13  
1.14  
1.15  
1.21  
1.22  
1.23  
1.24  
1.25  
1.3

# KEL-U

## Cable entry frames

### KEL-U 10, KEL-U-B



Description	Cut-out   Drilling template	Type	Cut-out dimensions mm	Grommets small   large	Order No.	PU
		KEL-U 10 6	36/46 × 65	6   –	54216	10
		KEL-U 10 6 with V2A screws	36/46 × 65	6   –	54216.200	10
		KEL-U 10 6 with threaded bushings M4	36/46 × 65	6   –	54216.400	10
		KEL-U 10 3	36/46 × 65	2   1	54212	10
		KEL-U 10 3 with V2A screws	36/46 × 65	2   1	54212.200	10
		KEL-U 10 3 with threaded bushings M4	36/46 × 65	2   1	54212.400	10
		KEL-U-B4	46 × 46	4   –	54204	10
		KEL-U-B4 with V2A screws	46 × 46	4   –	54204.200	10
		KEL-U-B4 with threaded bushings M4	46 × 46	4   –	54204.400	10
		KEL-U-B1	46 × 46	–   1	54206	10
		KEL-U-B1 with V2A screws	46 × 46	–   1	54206.200	10
		KEL-U-B1 with threaded bushings M4	46 × 46	–   1	54206.400	10



The KEL-U series is also available as a cleanroom version, see from page 403.  
Single-piece packaging units are available on request.

# KEL-E

## Cable entry frames



Description	Cut-out   Drilling template	Type	Cut-out dimensions mm	Grommets small   large	Order No.	PU
		KEL-E5	112 × 24	5   –	42250	10
		KEL-E5 with V2A screws	112 × 24	5   –	42250.200	10
		KEL-E5 with threaded bushings M4	112 × 24	5   –	42250.400	10
		KEL-E4	86 × 24	4   –	42259	10
		KEL-E4 with V2A screws	86 × 24	4   –	42259.200	10
		KEL-E4 with threaded bushings M4	86 × 24	4   –	42259.400	10
		KEL-E3	65 × 24	3   –	42258	10
		KEL-E3 with V2A screws	65 × 24	3   –	42258.200	10
		KEL-E3 with threaded bushings M4	65 × 24	3   –	42258.400	10
		KEL-E2	43 × 24	2   –	42249	10
		KEL-E2 with V2A screws	43 × 24	2   –	42249.200	10
		KEL-E2 with threaded bushings M4	43 × 24	2   –	42249.400	10
		KEL-E1	21 × 27	1   –	42261	10
		KEL-E1 with V2A screws	21 × 27	1   –	42261.200	10

1  
**1.11**  
 1.12  
 1.13  
 1.14  
 1.15  
 1.21  
 1.22  
 1.23  
 1.24  
 1.25  
 1.3

## KEL-FA series

### Cable entry frames

### “Fast Assembly”

### for a fast assembly without tools



The KEL-FA series (“Fast Assembly”) is a compact system for routing and sealing cables with and without connectors, as well as hoses and pneumatic cables.

After the frame has been equipped with the KT grommet system, the cover is put on and the two clamping levers are locked with the lower part by pressing them down. The twist-proof construction of the KEL-FA enables an intuitive assembly. The split cable entry allows for the routing of cables with a diameter of 1 mm to 35 mm, providing an IP54 rating.

The KEL-FA frames match exactly the cut-out dimensions for 10-, 16- and 24-pin standard industrial connectors. Either a cut-out of 36 mm or 46 mm in height can be chosen depending on the cables and connectors being routed.

The KEL-FA frames can either be screw mounted or simply snapped into the KEL-SNAP frame.

#### Advantages & benefits

- Fast assembly without tools
- Warranty on pre-terminated cables remains
- Retrofittings, repairs and maintenance can be done much more quickly
- Very high cable density with multi-hole grommets
- High flexibility with multi-range grommets and the IMAS-CONNECT™ system
- Strain relief according to EN 62444 (with single KT grommets)
- Integrated sealing

#### Specifications

Material	Polyamide (PA)
Flame class	UL 94 V-0, self-extinguishing
IP rating	IP54, with gasket and correct selection of cable grommets (certified acc. to EN 60529:2014-09)
Temperature	-40°C to +100°C (static)
Properties	Halogen-free, silicone-free
Frame depth	22 mm

#### Accessories

KT Cable grommets	74 - 89
AT Adapter grommets	90 - 101
KEL-SNAP Mounting frames	52 - 55
ST Plugs	85

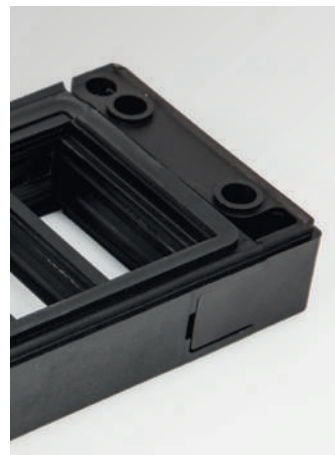

*Integrated sealing*



*Particularly easy assembly with the KEL-SNAP mounting frame*



# KEL-FA

## Cable entry frames

### “Fast Assembly”

#### KEL-FA 24



Description	Cut-out   Drilling template	Type	Cut-out dimensions mm	Grommets small   large	Order No.	PU
		KEL-FA 24 10	36/46 × 112	10   –	55241	10
		KEL-FA 24 7	36/46 × 112	6   1	55247	10
		KEL-FA 24 4	36/46 × 112	2   2	55244	10



- 1
- 1.11
- 1.12
- 1.13
- 1.14
- 1.15
- 1.21
- 1.22
- 1.23
- 1.24
- 1.25
- 1.3

**i** Single-piece packaging units are available on request.

# KEL-FA

## Cable entry frames

### “Fast Assembly”

#### KEL-FA 16



Description	Cut-out   Drilling template	Type	Cut-out dimensions mm	Grommets small   large	Order No.	PU
		KEL-FA 16 8	36/46 × 86	8   –	55168	10
		KEL-FA 16 5	36/46 × 86	4   1	55165	10
		KEL-FA 16 2	36/46 × 86	–   2	55162	10



**i** Single-piece packaging units are available on request.

# KEL-FA

## Cable entry frames

### “Fast Assembly”

#### KEL-FA 10



Description	Cut-out   Drilling template	Type	Cut-out dimensions mm	Grommets small   large	Order No.	PU
		KEL-FA 10 6	36/46 × 65	6   –	55216	10
		KEL-FA 10 3	36/46 × 65	2   1	55212	10



**i** Single-piece packaging units are available on request.

- 1
- 1.11
- 1.12
- 1.13
- 1.14
- 1.15
- 1.21
- 1.22
- 1.23
- 1.24
- 1.25
- 1.3

# KEL series

## Cable entry frames with IP54 rating



The classic KEL is a centrally split cable entry system for routing cables with connectors, providing an IP54/up to UL Type 12 rating.

The split KT grommet matching the cable diameter is placed around the cable and inserted into the cable entry frame. The split cable entry frames KEL match exactly the cut-out dimensions of 10-, 16- and 24-pin standard industrial connectors. Either a cut-out of 36 mm or 46 mm in height can be chosen depending on the cables being routed. The size KEL-B matches the cut-out dimensions of 46 × 46 mm measuring instruments.

Based on the frame sizes KEL 16 and KEL 24, there are also extended versions with additional middle frames available. Thus allowing a quick, easy and cost effective routing solution for up to 120 cables or hoses.

For tool-free assembly/disassembly of the cable entry frames the snap mounting frame KEL-SNAP can be used. All frame systems come with a rubber gasket.

The version with threaded bushings enables the cable entry frame to be screwed onto the housing from the inside out. This protects against vandalism and tampering with the housing from the outside.

### Advantages & benefits

- Maintain manufacturer's warranty on pre-terminated cables
- Retrofittings, repairs and maintenance can be done more easily and quickly
- High cable density, wide variety of grommets
- Strain relief according to EN 62444
- High stability, vibration resistant
- Can be combined with IMAS-CONNECT adapter grommets

### Specifications

Material	Polyamide (PA)
Flame class	UL 94 V-0, self-extinguishing
IP rating	IP54, with gasket and correct selection of cable grommets (certified acc. to EN 60529)
UL type rating	UL type 12 (acc. to UL 50E)
Temperature	-40°C to +140°C (static)
Properties	Halogen-free, silicone-free
Frame depth	17 mm

### Accessories

KT Cable grommets	74 - 89
AT Adapter grommets	90 - 101
KEL-SNAP Mounting frames	52 - 55
KEL-EMC Cable collectors	260 - 262
KDR Base plates	300 - 313
FP Flange plates	320 - 329
MP Module plates	314 - 315
ST Plugs	85



The cable entry frames enable the integration of the IMAS-CONNECT™ adapter grommets



Also available with stainless steel screws (V2A)



Also available with threaded bushings

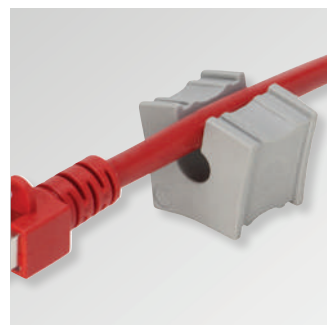

Split KT grommets



Can be combined with IMAS-CONNECT adapter grommets



Single-piece packaging units are available on request.

# KEL

## Cable entry frames

### KEL 24



Description	Cut-out   Drilling template	Type	Cut-out dimensions mm	Grommets small   large	Order No.	PU
		KEL 24 10	36/46 × 112	10   –	42241	10
		KEL 24 10 with V2A screws	36/46 × 112	10   –	42241.200	10
		KEL 24 10 with threaded bushings M4	36/46 × 112	10   –	42241.400	10
		KEL 24 7	36/46 × 112	6   1	42247	10
		KEL 24 7 with V2A screws	36/46 × 112	6   1	42247.200	10
		KEL 24 7 with threaded bushings M4	36/46 × 112	6   1	42247.400	10
		KEL 24 5	36/46 × 112	5   –	42248	10
		KEL 24 5 with V2A screws	36/46 × 112	5   –	42248.200	10
		KEL 24 5 with threaded bushings M4	36/46 × 112	5   –	42248.400	10
		KEL 24 4	36/46 × 86	2   2	42244	10
		KEL 24 4 with V2A screws	36/46 × 86	2   2	42244.200	10
		KEL 24 4 with threaded bushings M4	36/46 × 86	2   2	42244.400	10

**i** Single-piece packaging units are available on request.

- 1
- 1.11
- 1.12
- 1.13
- 1.14
- 1.15
- 1.21
- 1.22
- 1.23
- 1.24
- 1.25
- 1.3

# KEL

## Cable entry frames

### KEL 16



Description	Cut-out   Drilling template	Type	Cut-out dimensions mm	Grommets small   large	Order No.	PU
		KEL 16 8	36/46 × 86	8   -	42168	10
		KEL 16 8 with V2A screws	36/46 × 86	8   -	42168.200	10
		KEL 16 8 with threaded bushings M4	36/46 × 86	8   -	42168.400	10
		KEL 16 5	36/46 × 86	4   1	42165	10
		KEL 16 5 with V2A screws	36/46 × 86	4   1	42165.200	10
		KEL 16 5 with threaded bushings M4	36/46 × 86	4   1	42165.400	10
		KEL 16 4	36/46 × 86	4   -	42164	10
		KEL 16 4 with V2A screws	36/46 × 86	4   -	42164.200	10
		KEL 16 4 with threaded bushings M4	36/46 × 86	4   -	42164.400	10
		KEL 16 2	36/46 × 86	-   2	42162	10
		KEL 16 2 with V2A screws	36/46 × 86	-   2	42162.200	10
		KEL 16 2 with threaded bushings M4	36/46 × 86	-   2	42162.400	10

**i** Single-piece packaging units are available on request.

# KEL

## Cable entry frames

### KEL 10, KEL-B



Description	Cut-out   Drilling template	Type	Cut-out dimensions mm	Grommets small   large	Order No.	PU
		KEL 10 6	36/46 × 65	6   –	42216	10
		KEL 10 6 with V2A screws	36/46 × 65	6   –	42216.200	10
		KEL 10 6 with threaded bushings M4	36/46 × 65	6   –	42216.400	10
		KEL 10 3	36/46 × 65	2   1	42212	10
		KEL 10 3 with V2A screws	36/46 × 65	2   1	42212.200	10
		KEL 10 3 with threaded bushings M4	36/46 × 65	2   1	42212.400	10
		KEL-B4	46 × 46	4   –	42204	10
		KEL-B4 with V2A screws	46 × 46	4   –	42204.200	10
		KEL-B4 with threaded bushings M4	46 × 46	4   –	42204.400	10
		KEL-B1	46 × 46	–   1	42206	10
		KEL-B1 with V2A screws	46 × 46	–   1	42206.200	10
		KEL-B1 with threaded bushings M4	46 × 46	–   1	42206.400	10

Single-piece packaging units are available on request.

- 1
- 1.11
- 1.12
- 1.13
- 1.14
- 1.15
- 1.21
- 1.22
- 1.23
- 1.24
- 1.25
- 1.3

## KEL series

### Cable entry frames, extended with IP54 rating



Based on the frame sizes KEL 16 and KEL 24, there are also extended versions with additional middle frames available. Thus allowing a quick, easy and cost effective routing solution for up to 120 cables or hoses.

A flat rubber gasket is included in the shipment.

The version with threaded bushings enables the cable entry frame to be screwed onto the housing from the inside out. This protects against vandalism and tampering with the housing from the outside.

#### Advantages & benefits

- Maintain manufacturer's warranty on pre-terminated cables
- Retrofittings, repairs and maintenance can be done much more easily and quickly
- High cable density
- Strain relief according to EN 62444
- High stability, vibration resistant
- Can be combined with IMAS-CONNECT adapter grommets
- Great variability in the cable grommets

#### Specifications

Material	Polyamide (PA)
Flame class	UL 94 V-0, self-extinguishing
IP rating	IP54, with gasket and correct selection of cable grommets (certified acc. to EN 60529)
UL type rating	UL type 12 (acc. to UL 50E)
Temperature	-40°C to +140°C (static)
Properties	Halogen-free, silicone-free
Frame depth	17 mm

#### Accessories

KT Cable grommets	74 - 89
AT Adapter grommets	90 - 101
KEL-SNAP Mounting frames	52 - 55
KEL-EMC Cable collectors	260 - 262
ST Plugs	85



The cable entry frames enable the integration of the IMAS-CONNECT™ adapter grommets



Also available with stainless steel screws (V2A)



Also available with threaded bushings

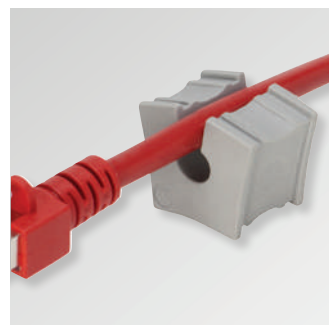

Split KT grommets



# KEL

## Cable entry frames

### KEL-24-E



Description	Cut-out   Drilling template	Type	Cut-out dimensions mm	Grommets small   large	Order No.	PU
		KEL 24 15-E	66 x 112	15   -	42209	1
		KEL 24 15-E with V2A screws	66 x 112	15   -	42209.200	1
		KEL 24 15-E with threaded bushings M4	66 x 112	15   -	42209.400	1
		KEL 24 12-E	66 x 112	11   1	42208	1
		KEL 24 12-E with V2A screws	66 x 112	11   1	42208.200	1
		KEL 24 12-E with threaded bushings M4	66 x 112	11   1	42208.400	1
		KEL 24 9-E	66 x 112	7   2	42207	1
		KEL 24 9-E with V2A screws	66 x 112	7   2	42207.200	1
		KEL 24 9-E with threaded bushings M4	66 x 112	7   2	42207.400	1
		KEL 24 10-E	66 x 112	10   -	49056	1
		KEL 24 10-E with V2A screws	66 x 112	10   -	49056.200	1
		KEL 24 10-E with threaded bushings M4	66 x 112	10   -	49056.400	1

- 1
- 1.11
- 1.12
- 1.13
- 1.14
- 1.15
- 1.21
- 1.22
- 1.23
- 1.24
- 1.25
- 1.3

# KEL

## Cable entry frames

### KEL-24-MT



Description	Cut-out   Drilling template	Type	Cut-out dimensions mm	Grommets small   large	Order No.	PU
		KEL 24 20-MT	82 x 112	20   -	42232	1
		KEL 24 20-MT with V2A screws	82 x 112	20   -	42232.200	1
		KEL 24 20-MT with threaded bushings M4	82 x 112	20   -	42232.400	1
		KEL 24 17-MT	82 x 112	16   1	42224	1
		KEL 24 17-MT with V2A screws	82 x 112	16   1	42224.200	1
		KEL 24 17-MT with threaded bushings M4	82 x 112	16   1	42224.400	1
		KEL 24 14-MT	82 x 112	12   2	42225	1
		KEL 24 14-MT with V2A screws	82 x 112	12   2	42225.200	1
		KEL 24 14-MT with threaded bushings M4	82 x 112	12   2	42225.400	1
		KEL 24 11-MT	82 x 112	8   3	42222	1
		KEL 24 11-MT with V2A screws	82 x 112	8   3	42222.200	1
		KEL 24 11-MT with threaded bushings M4	82 x 112	8   3	42222.400	1
		KEL 24 8-MT	82 x 112	4   4	42221	1
		KEL 24 8-MT with V2A screws	82 x 112	4   4	42221.200	1
		KEL 24 8-MT with threaded bushings M4	82 x 112	4   4	42221.400	1

# KEL

## Cable entry frames

### KEL-24-2MT



Description	Cut-out   Drilling template	Type	Cut-out dimensions mm	Grommets small   large	Order No.	PU
		KEL 24 30-2MT	126 x 112	30   -	42234	1
		KEL 24 30-2MT with V2A screws	126 x 112	30   -	42234.200	1
		KEL 24 30-2MT with threaded bushings M4	126 x 112	30   -	42234.400	1
		KEL 24 27-2MT	126 x 112	26   1	42233	1
		KEL 24 27-2MT with V2A screws	126 x 112	26   1	42233.200	1
		KEL 24 27-2MT with threaded bushings M4	126 x 112	26   1	42233.400	1
		KEL 24 24-2MT	126 x 112	22   2	42227	1
		KEL 24 24-2MT with V2A screws	126 x 112	22   2	42227.200	1
		KEL 24 24-2MT with threaded bushings M4	126 x 112	22   2	42227.400	1
		KEL 24 21-2MT	126 x 112	18   3	42226	1
		KEL 24 21-2MT with V2A screws	126 x 112	18   3	42226.200	1
		KEL 24 21-2MT with threaded bushings M4	126 x 112	18   3	42226.400	1
		KEL 24 12-2MT	126 x 112	6   6	42223	1
		KEL 24 12-2MT with V2A screws	126 x 112	6   6	42223.200	1
		KEL 24 12-2MT with threaded bushings M4	126 x 112	6   6	42223.400	1

1  
1.11  
1.12  
1.13  
1.14  
1.15  
1.21  
1.22  
1.23  
1.24  
1.25  
1.3

# KEL

## Cable entry frames

### KEL 16-E, KEL 16-MT



Description	Cut-out   Drilling template	Type	Cut-out dimensions mm	Grommets small   large	Order No.	PU
		KEL 16 12-E	66 x 86	12   -	42141	1
		KEL 16 12-E with V2A screws	66 x 86	12   -	42141.200	1
		KEL 16 12-E with threaded bushings M4	66 x 86	12   -	42141.400	1
		KEL 16 6-E	66 x 86	4   2	42140	1
		KEL 16 6-E with V2A screws	66 x 86	4   2	42140.200	1
		KEL 16 6-E with threaded bushings M4	66 x 86	4   2	42140.400	1
		KEL 16 16-MT	82 x 86	16   -	42145	1
		KEL 16 16-MT with V2A screws	82 x 86	16   -	42145.200	1
		KEL 16 16-MT with threaded bushings M4	82 x 86	16   -	42145.400	1
		KEL 16 10-MT	82 x 86	8   2	42144	1
		KEL 16 10-MT with V2A screws	82 x 86	8   2	42144.200	1
		KEL 16 10-MT with threaded bushings M4	82 x 86	8   2	42144.400	1
		KEL 16 4-MT	82 x 86	-   4	42143	1
		KEL 16 4-MT with V2A screws	82 x 86	-   4	42143.200	1
		KEL 16 4-MT with threaded bushings M4	82 x 86	-   4	42143.400	1

# KEL

## Cable entry frames

### KEL 16-2MT



Description	Cut-out   Drilling template	Type	Cut-out dimensions mm	Grommets small   large	Order No.	PU
		KEL 16 24-2MT	126 x 86	24   -	42149	1
		KEL 16 24-2MT with V2A screws	126 x 86	24   -	42149.200	1
		KEL 16 24-2MT with threaded bushings M4	126 x 86	24   -	42149.400	1
		KEL 16 12-2MT	126 x 86	8   4	42148	1
		KEL 16 12-2MT with V2A screws	126 x 86	8   4	42148.200	1
		KEL 16 12-2MT with threaded bushings M4	126 x 86	8   4	42148.400	1
		KEL 16 6-2MT	126 x 86	-   6	42147	1
		KEL 16 6-2MT with V2A screws	126 x 86	-   6	42147.200	1
		KEL 16 6-2MT with threaded bushings M4	126 x 86	-   6	42147.400	1

- 1
- 1.11
- 1.12
- 1.13
- 1.14
- 1.15
- 1.21
- 1.22
- 1.23
- 1.24
- 1.25
- 1.3

# KEL 183

## Cable entry frames for supply cables

### KTMB 183

#### Grommets for KEL 183



The split cable entry frame KEL 183 enables the user to route cables and tubes with a diameter of up to 75 mm (depending on the frame type) and to seal them in accordance with IP54/up to UL type 12. For cables up to 35 mm the cable grommets KT can be used. With these split cable grommets, pre-terminated cables can be routed.

For cables up to 75 mm we have created the grommets KTMB for KEL 183. Those are not split and have a defined area for pushing the cable through.

The blank grommet KTMB-O can accept cable sizes within a specified range. The membrane of the KTMB-O can be pierced or cut (cable diameter minus 10 mm) for cables up to 55 mm in diameter.

All frame systems come with a rubber gasket.

#### Advantages & benefits

- Installation of cables up to 75 mm
- Grommets allow rigid cables to be properly positioned and oriented during the installation process
- Retrofittings, repairs and maintenance can be done much more easily and quickly
- Can be combined with IMAS-CONNECT adapter grommets
- Great variability in the cable grommets

#### Specifications

Material	KEL 183: Polyamide (PA) KTMB: Elastomere
Flame class	UL 94 V-0, self-extinguishing
IP rating	IP54 with gasket and correct selection of the cables (certified acc. to EN 60529)
UL type rating	UL type 12 (acc. to UL 50E)
Temperature	KEL 183: -40°C to +140°C (static) KTMB: -40°C to +100°C (static)
Properties	Halogen-free, silicone-free
Frame depth	17 mm

#### Accessories

KT Cable grommets	74 - 89
AT Adapter grommets	90 - 101
KEL-EMC Cable collectors	260 - 262
ST Plugs	85

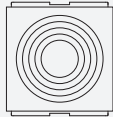
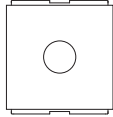
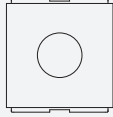
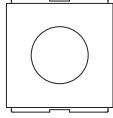
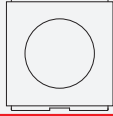
Type	Order No.	Clamping range	PU	
	KTMB-O	41410	Blank grommet	1
	KTMB-P	41415	34 – 44 mm	1
	KTMB-Q	41420	44 – 54 mm	1
	KTMB-R	41425	54 – 64 mm	1
	KTMB-S	41430	64 – 75 mm	1

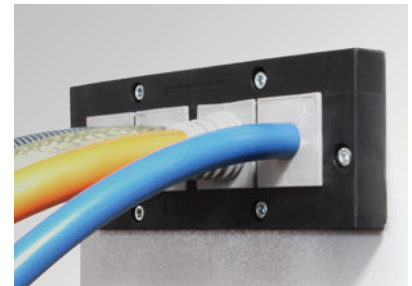

Cable entry frames  
for supply cables up to 75 mm  
KEL 183, KEL 183-E



Description	Cut-out   Drilling template	Type	Cut-out mm	Grommets KT KT 183   KT large	Order No.	PU
		KEL 183 2	180 x 80 mm	2   -	47200	1
		KEL 183 2 with V2A screws	180 x 80 mm	2   -	47200.200	1
		KEL 183 5	180 x 80 mm	1   4	47220	1
		KEL 183 5 with V2A screws	180 x 80 mm	1   4	47220.200	1
		KEL 183 8	180 x 80 mm	-   8	47240	1
		KEL 183 8 with V2A screws	180 x 80 mm	-   8	47240.200	1
		KEL 183-E4	180 x 42 mm	-   4	47250	1
		KEL 183-E4 with V2A screws	180 x 42 mm	-   4	47250.200	1
		KEL 183-E16	180 x 42 mm	16 KT small	47255	1
		KEL 183-E16 with V2A screws	180 x 42 mm	16 KT small	47255.200	1

- 1
- 1.11**
- 1.12
- 1.13
- 1.14
- 1.15
- 1.21
- 1.22
- 1.23
- 1.24
- 1.25
- 1.3

# KEL-FL

## Cable entry frames for flat cables

### FT

### Grommets for flat cables



The KEL-FL range enables simple, fast and flexible cable routing and sealing of flat wires, e.g. in lift construction.

Innovative construction of the grommets compensates for manufacturing inconsistencies in flat cables. Split KT grommets can be utilised to additionally route round cables with connectors. All frame systems come with a rubber gasket.

FT grommets are used to route flat cables, e.g. in lift construction. Suitable for cable entry frames KEL-FL. Innovative construction of the grommets compensates for manufacturing inconsistencies in flat cables.

#### Advantages & benefits

- Routing of flat cables in combination with pre-terminated round cables by using a single KEL-FL cable entry frame
- Routing of flat cables with various dimensions
- Space saving shape

#### Specifications

Material	KEL-FL: Polyamide (PA) FT: Elastomer
Flame class	UL 94 V-0, self-extinguishing
IP rating	IP54, with gasket and correct selection of the cable grommets
Temperature	KEL-FL: -40°C to +140°C (static) FT: -40°C to +100°C (static)
Properties	Halogen-free, silicone-free
Frame depth	17 mm

#### Accessories

KT Cable grommets, small	74 - 89
KTMB/KT-DPF Cable grommets, small	81 - 83
KEL-EMC Cable collectors	260 - 262
ST Plugs	85

Description	Type	Order No.	Clamping range	PU
	FT-1 0	46201	Blank grommet	5
	FT-1 A	46210	Width: 19 - 23 mm Thickness: 5.5 - 6 mm	5
	FT-1 B	46211	Width: 28 - 33 mm Thickness: 5.5 - 6 mm	5
	FT-1 C	46212	Width: 24 - 30 mm Thickness: 8.5 - 9 mm	5
	FT-1 E	46214	Width: 19 - 24 mm Thickness: 6.5 - 7 mm	5
	FT-1 F	46215	Width: 28 - 33 mm Thickness: 9 - 9.5 mm	5
	FT-2 0	46202	Blank grommet	5
	FT-2 A	46250	Width: 32.5 - 38 mm Thickness: 5 - 5.5 mm	5
	FT-2 B	46251	Width: 45 - 50.5 mm Thickness: 6 - 6.5 mm	5
	FT-2 C	46252	Width: 47 - 52 mm Thickness: 9.5 - 10 mm	5
	FT-2 F	46255	Width: 38 - 43 mm Thickness: 12.5 - 13 mm	5
	FT-2 G	46256	Width: 49 - 54 mm Thickness: 5 - 6 mm	5
	FT-3 0	46203	Blank grommet	5
	FT-3 A	46300	Width: 72 - 77 mm Thickness: 5 - 5.5 mm	5
	FT-4 0	46204	Blank grommet	5
	FT-4 A	46330	Width: 85 - 99 mm Thickness: 4.2 - 5.2 mm	5



# KEL-FL

## Cable entry frames for flat cables



Description	Cut-out   Drilling template	Type	Order No.	Cut-out [mm]	Grommets KT   FT	PU
		KEL-FL A	46100	43 × 24	0 × KT 1 × FT-1	10
		KEL-FL B	46105	65 × 24	0 × KT 1 × FT-2	10
		KEL-FL C	46110	65 × 24	1 × KT 1 × FT-1	10
		KEL-FL D	46115	86 × 24	0 × KT 1 × FT-3	10
		KEL-FL E	46120	86 × 24	1 × KT 1 × FT-2	10
		KEL-FL F	46125	86 × 24	0 × KT 2 × FT-1	10
		KEL-FL G	46130	86 × 24	2 × KT 1 × FT-1	10
		KEL-FL H	46135	112 × 24	2 × KT 1 × FT-2	10
		KEL-FL I	46140	112 × 24	1 × KT 2 × FT-1	10
		KEL-FL J	46145	112 × 24	3 × KT 1 × FT-1	10
		KEL-FL K	46150	112 × 24	1 × FT-1 1 × FT-2	10
		KEL-FL L	46155	112 × 24	1 × FT-4	10

1  
1.11  
1.12  
1.13  
1.14  
1.15  
1.21  
1.22  
1.23  
1.24  
1.25  
1.3

## KEL-FG-ER series

Flange enclosure for 90° cable transit with integrated seal and IP65 rating



The cable entry frames KEL-FG-ER are suited for installation of cables with connectors and conduits at an angle of 90° to the cabinet, enclosure or machine wall, providing an IP65 rating and strain relief according to EN 62444 for cable diameters from 1 to 16 mm (single-hole grommets KT 1 – 15) and 16 to 35 mm (single-hole grommets KT 16 – 34).

Due to the integrated seal on the flange enclosure, a protection class of up to IP65 is provided. An additional flat rubber gasket is included in the shipment.

The KEL-FG-ER-A frame matches exactly the cut-out dimensions for 24-pin standard industrial connectors (36 x 112 mm). The KEL-FG-ER-B is suited for cut-outs 36 x 46 mm.

The single-row version KEL-FG-ER-E is particularly suited for flat connectors. The small frame is ideal for applications with limited space.

The version with threaded bushings enables the cable entry frame to be screwed onto the housing from the inside out. This protects against vandalism and tampering with the housing from the outside.

### Advantages & benefits

- Integrated seal
- Installation at an angle of 90° to the wall
- Mechanical protection of the cable directly at the place of entry
- Protection against water splashes and drips
- Warranty on pre-terminated cables remains
- Ideal for cables with connectors (max. Ø 35 mm)
- Strain relief according to EN 62444
- High stability, vibration resistant
- Can be combined with IMAS-CONNECT adapter grommets

### Specifications

Material	Polyamide (PA)
Flame class	UL 94 V-0, self-extinguishing
IP rating	IP54, IP55, IP64, IP65 according to EN 60529
Temperature	-40°C to +80°C (static)
Properties	Halogen-free, silicone-free
Mounting height	57.5 mm

### Accessories

KT Cable grommets	74 - 89
AT Adapter grommets	90-101
KEL-EMC Cable collectors	260 - 262
ST Plugs	85

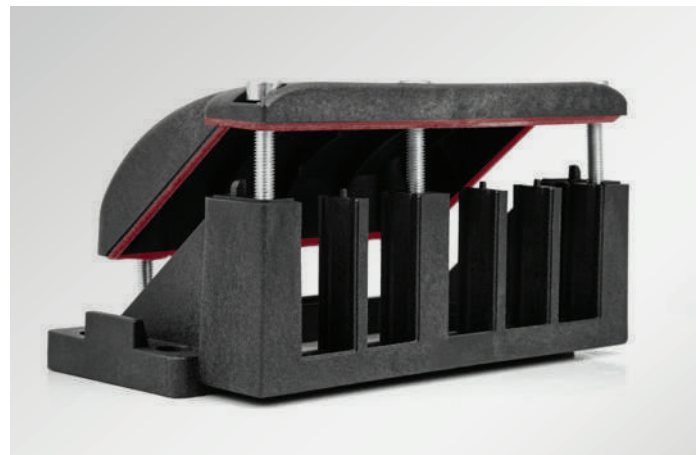

*Injected seal, highlighted here in red*



*Can be combined with IMAS-CONNECT adapter grommets*

# KEL-FG-ER

Flange enclosure for 90° cable transit

KEL-FG-ER A



Description	Cut-out   Drilling template	Type	Cut-out mm	Grommets small   large	Order No.	PU
		KEL-FG-ER A10	36 x 112	10   -	42340	1
		KEL-FG-ER A10 with V2A screws	36 x 112	10   -	42340.200	1
		KEL-FG-ER A10 with threaded bushings M4	36 x 112	10   -	42340.400	1
		KEL-FG-ER A7	36 x 112	6   1	42341	1
		KEL-FG-ER A7 with V2A screws	36 x 112	6   1	42341.200	1
		KEL-FG-ER A7 with threaded bushings M4	36 x 112	6   1	42341.400	1
		KEL-FG-ER A4	36 x 112	2   2	42342	1
		KEL-FG-ER A4 with V2A screws	36 x 112	2   2	42342.200	1
		KEL-FG-ER A4 with threaded bushings M4	36 x 112	2   2	42342.400	1

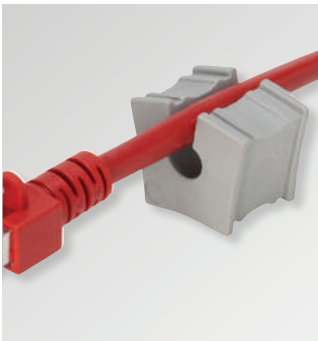

Split KT grommets

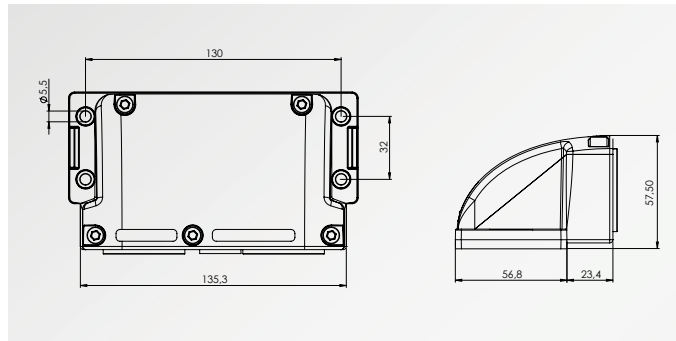

- 1
- 1.11
- 1.12
- 1.13
- 1.14
- 1.15
- 1.21
- 1.22
- 1.23
- 1.24
- 1.25
- 1.3

# KEL-FG-ER

Flange enclosure for 90° cable transit

KEL-FG-ER B



Description	Cut-out   Drilling template	Type	Cut-out mm	Grommets small   large	Order No.	PU
		KEL-FG-ER B4	46 x 36	4   -	42344	1
		KEL-FG-ER B4 with V2A screws	46 x 36	4   -	42344.200	1
		KEL-FG-ER B4 with threaded bushings M4	46 x 36	4   -	42344.400	1
		KEL-FG-ER B1	46 x 36	-   1	42343	1
		KEL-FG-ER B1 with V2A screws	46 x 36	-   1	42343.200	1
		KEL-FG-ER B1 with threaded bushings M4	46 x 36	-   1	42343.400	1

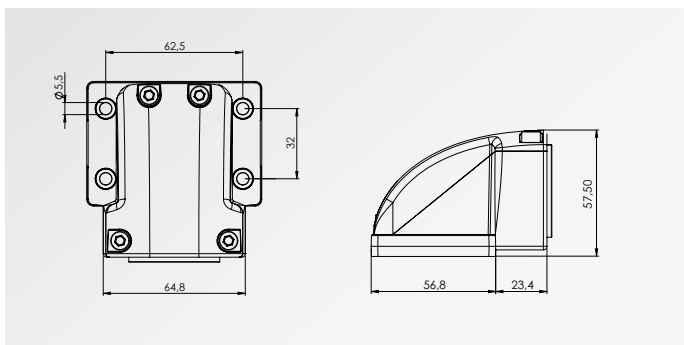

# KEL-FG-ER

Flange enclosure for 90° cable transit

KEL-FG-ER E



Description	Cut-out   Drilling template	Type	Cut-out mm	Grommets small   large	Order No.	PU
		KEL-FG-ER E2	43 x 24	2   -	42345	5
		KEL-FG-ER E2 with V2A screws	43 x 24	2   -	42345.200	5
		KEL-FG-ER E2 with threaded bushings M4	43 x 24	2   -	42345.400	5
		KEL-FG-ER E3	65 x 24	3   -	42346	5
		KEL-FG-ER E3 with V2A screws	65 x 24	3   -	42346.200	5
		KEL-FG-ER E3 with threaded bushings M4	65 x 24	3   -	42346.400	5
		KEL-FG-ER E5	112 x 24	5   -	42347	5
		KEL-FG-ER E5 with V2A screws	112 x 24	5   -	42347.200	5
		KEL-FG-ER E5 with threaded bushings M4	112 x 24	5   -	42347.400	5

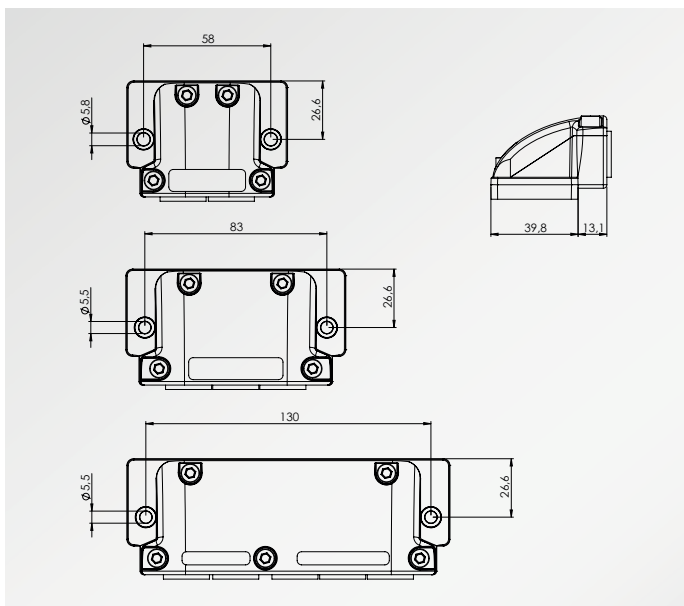

- 1
- 1.11
- 1.12
- 1.13
- 1.14
- 1.15
- 1.21
- 1.22
- 1.23
- 1.24
- 1.25
- 1.3

## KEL-FG series

### Flange enclosure for 90° cable transit with IP54 rating



The cable entry frames KEL-FG are suited for installation, sealing and strain relief of cables with connectors and conduits at an angle of 90° to the cabinet, enclosure or machine wall.

The KEL-FG-A frame matches exactly the cut-out dimensions for 24-pin standard industrial connectors. For tool-free assembly/disassembly of the KEL-FG-A the snap mounting frame KEL-SNAP 24 can be used. The KEL-FG-B is suited for cut-outs 36 × 46 mm.

The single-row versions KEL-FG-E are particularly suited for flat connectors. The small frames are ideal for applications with limited space.

The version with threaded bushings enables the cable entry frame to be screwed onto the housing from the inside out. This protects against vandalism and tampering with the housing from the outside.

A flat rubber gasket is included in the shipment.

#### Advantages & benefits

- Installation at an angle of 90° to the wall
- Mechanical protection of cable directly at the place of entry
- Protection against water spray and drips
- Maintain manufacturer's warranty on pre-terminated cables
- Strain relief according to EN 62444
- High stability, vibration resistant
- Can be combined with IMAS-CONNECT adapter grommets

#### Specifications

Material	Polyamide (PA)
Flame class	UL 94 V-0, self-extinguishing
IP rating	IP54, with gasket and correct selection of the cable grommets
Temperature	-40°C to +140°C (static)
Properties	Halogen-free, silicone-free

#### Accessories

KT Cable grommets	74 - 89
AT Adapter grommets	90 - 101
KEL-SNAP Mounting frames	52 - 55
KEL-EMC Cable collectors	260 - 262
ST Plugs	85

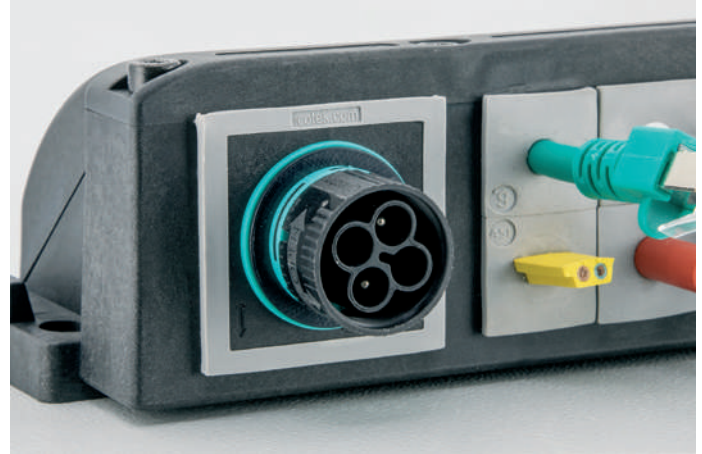

The cable entry frames enable the integration of the IMAS-CONNECT™ adapter grommets



Also available with stainless steel screws (V2A)



Also available with threaded bushings

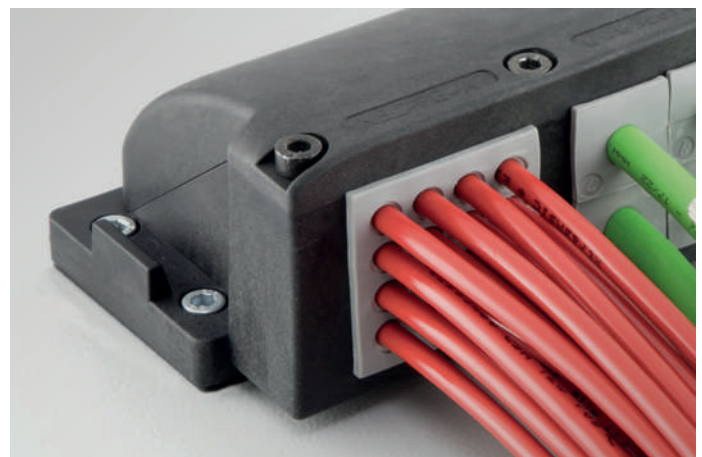

# KEL-FG

Flange enclosure for 90° cable transit

KEL-FG-A



Description	Cut-out   Drilling template	Type	Cut-out mm	Grommets small   large	Order No.	PU
		KEL-FG-A10	36 x 112	10   -	42320	1
		KEL-FG-A10 with V2A screws	36 x 112	10   -	42320.200	1
		KEL-FG-A10 with threaded bushings M4	36 x 112	10   -	42320.400	1
		KEL-FG-A7	36 x 112	6   1	42322	1
		KEL-FG-A7 with V2A screws	36 x 112	6   1	42322.200	1
		KEL-FG-A7 with threaded bushings M4	36 x 112	6   1	42322.400	1
		KEL-FG-A4	36 x 112	2   2	42324	1
		KEL-FG-A4 with V2A screws	36 x 112	2   2	42324.200	1
		KEL-FG-A4 with threaded bushings M4	36 x 112	2   2	42324.400	1



KEL-FG-A

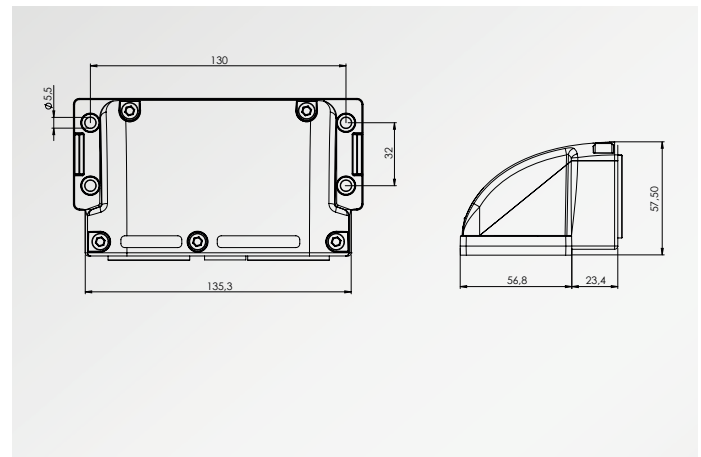

- 1
- 1.11
- 1.12
- 1.13
- 1.14
- 1.15
- 1.21
- 1.22
- 1.23
- 1.24
- 1.25
- 1.3

# KEL-FG

Flange enclosure for 90° cable transit

KEL-FG-B



Description	Cut-out   Drilling template	Type	Cut-out mm	Grommets small   large	Order No.	PU
		KEL-FG-B4	46 x 36	4   -	42330	1
		KEL-FG-B4 with V2A screws	46 x 36	4   -	42330.200	1
		KEL-FG-B4 with threaded bushings M4	46 x 36	4   -	42330.400	1
		KEL-FG-B1	46 x 36	-   1	42332	1
		KEL-FG-B1 with V2A screws	46 x 36	-   1	42332.200	1
		KEL-FG-B1 with threaded bushings M4	46 x 36	-   1	42332.400	1

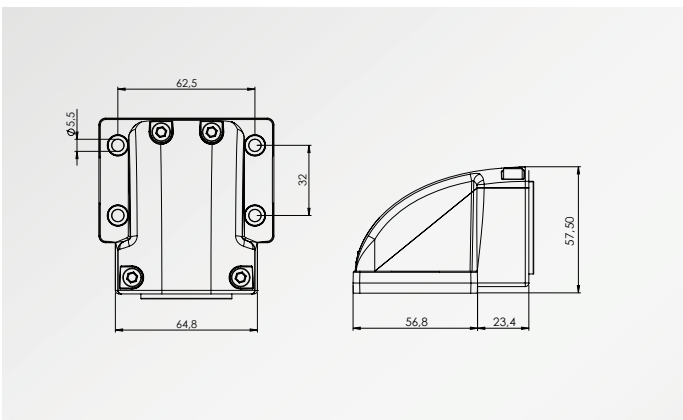



# KEL-FG

Flange enclosure for 90° cable transit

KEL-FG-E



Description	Cut-out   Drilling template	Type	Cut-out mm	Grommets small   large	Order No.	PU
		KEL-FG-E2	43 x 24	2   -	42333	5
		KEL-FG-E2 with V2A screws	43 x 24	2   -	42333.200	5
		KEL-FG-E2 with threaded bushings M4	43 x 24	2   -	42333.400	5
		KEL-FG-E3	65 x 24	3   -	42334	5
		KEL-FG-E3 with V2A screws	65 x 24	3   -	42334.200	5
		KEL-FG-E3 with threaded bushings M4	65 x 24	3   -	42334.400	5
		KEL-FG-E5	112 x 24	5   -	42336	5
		KEL-FG-E5 with V2A screws	112 x 24	5   -	42336.200	5
		KEL-FG-E5 with threaded bushings M4	112 x 24	5   -	42336.400	5

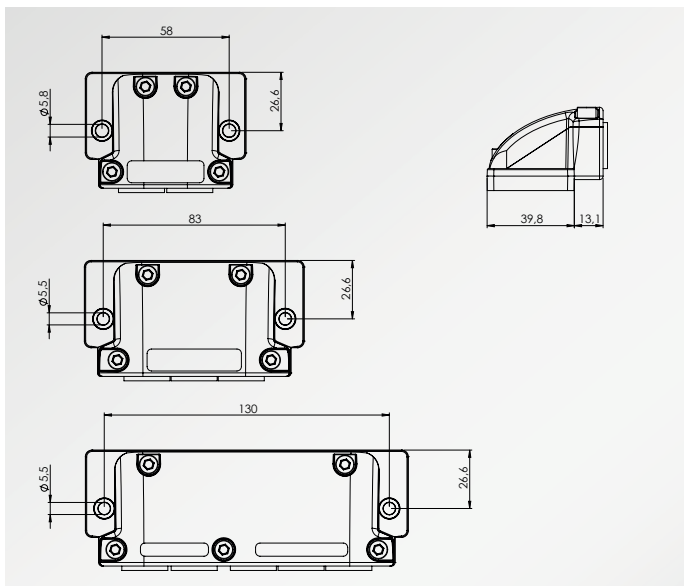

**i** Single-piece packaging units are available on request.

- 1
- 1.11
- 1.12
- 1.13
- 1.14
- 1.15
- 1.21
- 1.22
- 1.23
- 1.24
- 1.25
- 1.3

# KEL-FW

## Bulkhead for 90° cable transit with IP65 rating



With the new bulkhead KEL-FW, cables can be routed at a 90° angle over a large bending radius. The hinged cover is firmly connected to the housing by a hinge and is therefore captive. This makes the system very easy and quick to mount. The KEL-FW is first screwed to the enclosure using the two rear holes and then fitted with the required cable grommets. The cover is then folded down, locked in place and screwed to the enclosure using the two front holes.

The KEL-FW is fitted with an integrated seal to achieve the high protection rating of IP65. An additional flat gasket for wall mounting is included in the shipment.

Cables with and without connectors up to a diameter of 35 mm can be routed and strain-relieved according to DIN EN 62444. Retrofitting and maintenance can be carried out quickly and easily.

### Advantages

- Captive cover
- Integrated seal
- Cable entry at 90° to the enclosure
- Large bending radius of the routed cables possible (r max. = 150 mm), ideal for rigid cables
- Mechanical protection of the cable directly at the place of entry
- Protection against water splashes and drips
- Warranty on pre-terminated cables remains
- Retrofittings and maintenance can be done quickly and easily
- Ideal for cables with connectors (max. Ø 35 mm)
- Strain relief according to EN 62444
- High stability, vibration resistant
- Can be combined with IMAS-CONNECT adapter grommets

### Specifications

Material	Polyamide (PA)
Colour	Black (RAL 9005)
IP rating	IP65 (certified acc. to EN 60529)
Flame class	UL 94 V-0, self-extinguishing
Temperature	-40°C to +90°C (static)
Properties	Halogen free, silicone free

### Accessories

CONFiX Sheet metal punches	388
KT Cable grommets	74 - 89
IMAS-CONNECT Adapter grommets	90 - 101

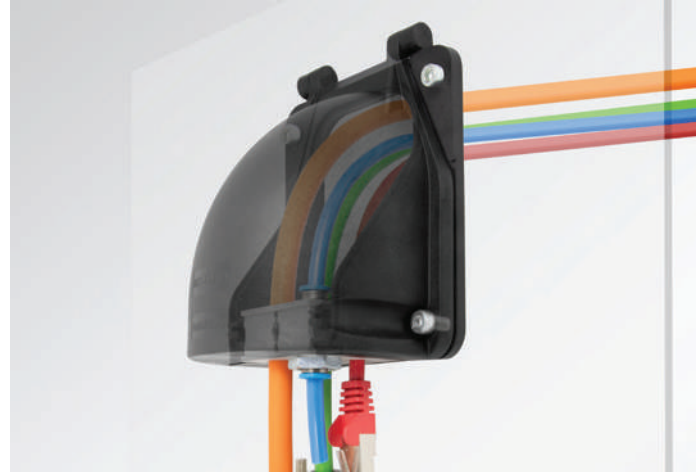

*Captive cover for easy assembly*

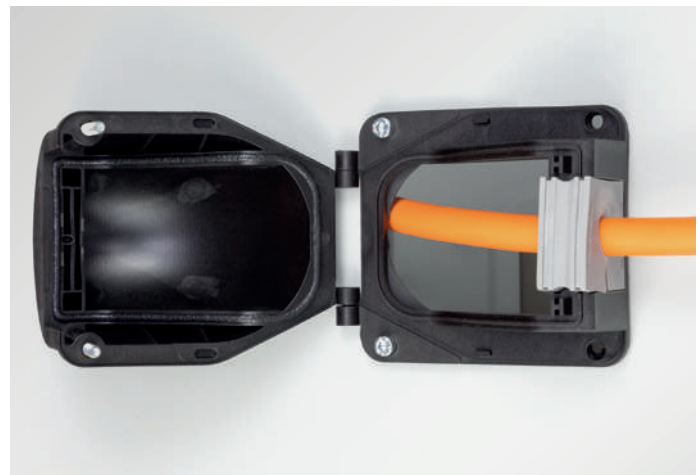

*Integrated seal to achieve the high protection rating of IP65*



# KEL-FW

Bulkhead  
for 90° cable transit  
with IP65 rating



Description	Cut-out   Drilling template	Type	Dimension A x B x H mm	Cut-out mm	Bore $\phi$	Grommets small   large	Order No.	PU
		KEL-FW-B1	121,5 x 100,5 x 75,0	62 x 86 mm	4 x 6,5 mm	-   1	42460	1
		KEL-FW-B4	121,5 x 100,5 x 75,0	62 x 86 mm	4 x 6,5 mm	4   -	42461	1

**i** Matching sheet metal punches on p. 374

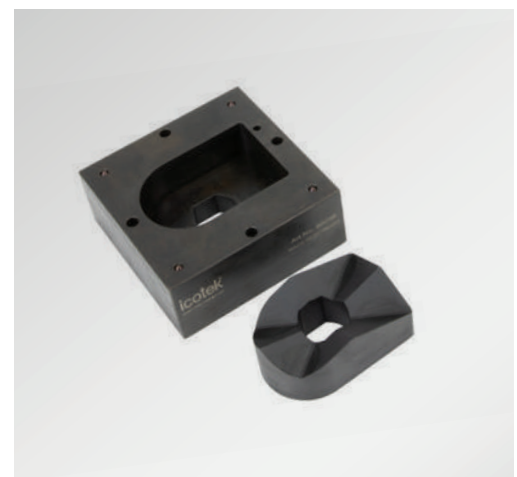
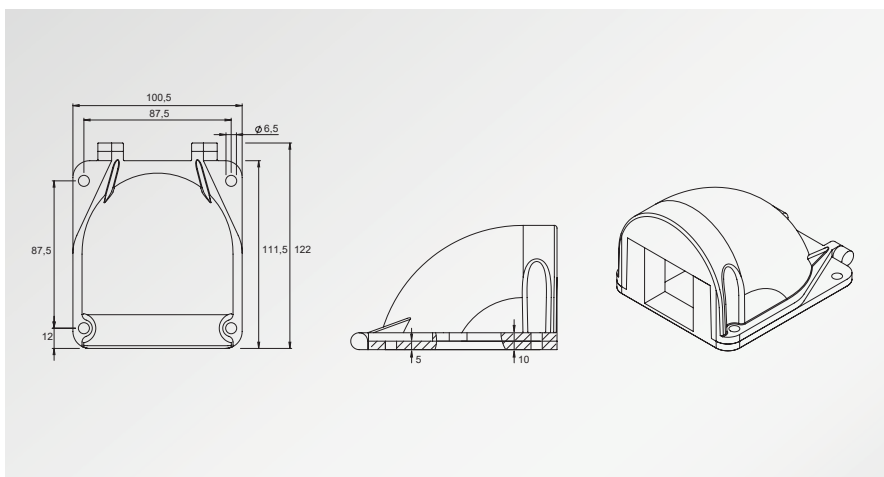

- 1
- 1.11
- 1.12
- 1.13
- 1.14
- 1.15
- 1.21
- 1.22
- 1.23
- 1.24
- 1.25
- 1.3

# KEL-SNAP-S

## Split snap-on mounting frames with IP54 rating

IP54

icotek also offers the proven snap-on frame KEL-SNAP as a split version KEL-SNAP-S. The snap-in frames enable quick and tool-free assembly of the KEL-FA/KEL/KEL-U/KEL-QUICK/KEL-FG-A cable entry systems.

The KEL-SNAP becomes even more versatile with the "S" version. Due to the divisibility of the snap-on frame, it can also be retrofitted without any problems. If an already mounted KEL-SNAP is damaged, it can be replaced by a split frame without having to disconnect all the cables that have already been fed through and without having to dismantle the existing KEL.

### Advantages & benefits

- Subsequent assembly possible
- Upon disassembly (e.g. maintenance) screwing and unscrewing of the cable entry frame is not necessary
- Drilling template identical to cable entry frame
- Integrated gasket
- Previously assembled cable harnesses are quickly and easily attached
- There is no need to thread the cables through the snap-on frame as the divisible frame can be snapped together when the cables have already been passed through the cut-out

### Specifications

Material	Polyamide (PA)
IP rating	IP 54
Flame class	UL 94 V-0, self-extinguishing
Temperature	-40°C bis +140°C (static)
Properties	silicone free, halogen free

### Compatible with

KEL-FA Cable entry frames	24 - 27
KEL Cable entry frames	28 - 37
KEL-U Cable entry frames	20 - 22
KEL-FG Flange enclosure	46 - 49
KEL-QUICK Cable entry frames	105 - 107
MP Module plates	314 - 315
BPK-SNAP Blank plates	332

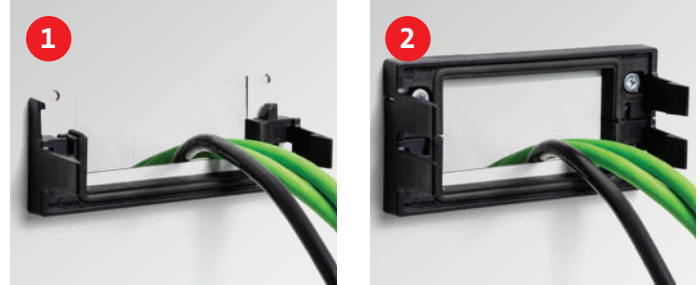

Integrated circumferential seal (IP54) Snap-in locking hook

# KEL-SNAP-S

## Splittable snap-on mounting frame

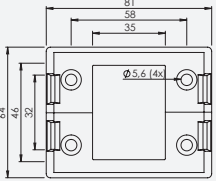
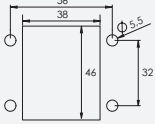
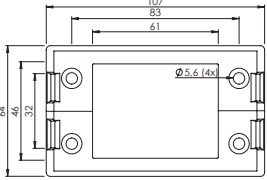
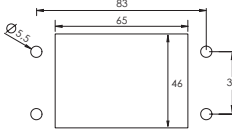
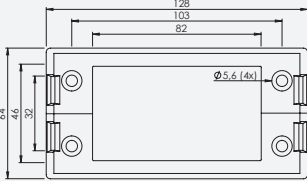
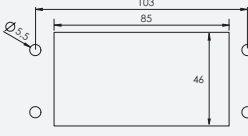
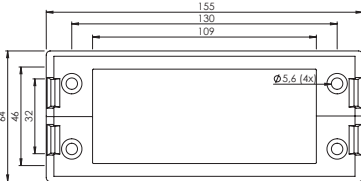
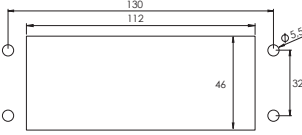

Description	Cut-out   Drilling template	Type	Cut-out [mm]	Suitable for	Order No.	PU
		KEL-SNAP-S-B	46 × 38	KEL-B KEL-U-B KEL-QUICK-B	42063	10
		KEL-SNAP-S-10	46 × 65	KEL 10 KEL-U 10 KEL-QUICK 10	42062	10
		KEL-SNAP-S-16	46 × 85	KEL 16 KEL-U 16 KEL-QUICK 16	42061	10
		KEL-SNAP-S-24	46 × 112	KEL 24 KEL-U 24 KEL-FG-A KEL-QUICK 24	42060	10

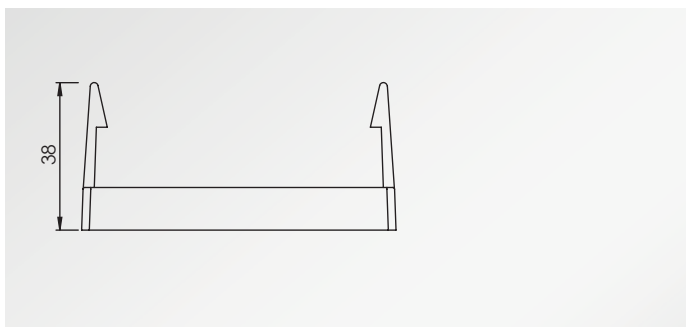

Single-piece packaging units are available on request.

- 1
- 1.11
- 1.12
- 1.13
- 1.14
- 1.15
- 1.21
- 1.22
- 1.23
- 1.24
- 1.25
- 1.3

# KEL-SNAP

## Snap-on mounting frames with IP54 rating



The patented KEL-SNAP frame provides a quick snap-in assembly of the KEL-FA/KEL/KEL-U/KEL-QUICK/KEL-FG-A cable entry systems. Control panels, cabinets or machines can be equipped with the KEL-SNAP frame at delivery, allowing a simple push in of the KEL frame when routing cables and conduit. Perfect for enclosures that are maintenance intensive or for an install at a later date.

A cut-out of 46 mm can also be chosen instead of 36 mm. Thus prefabricated multi-pin connectors can be used.

### Advantages & benefits

- Upon disassembly (e.g. maintenance) screwing and unscrewing of KEL frame is not necessary
- Previously assembled KEL frames are quickly and easily attached
- Integrated gasket
- Drilling template identical to KEL frame (except KEL-SNAP-B)

### Specifications

Material	Polyamide (PA)
Flame class	UL94V-0, self-extinguishing
IP rating	IP54 (certified acc. to EN 60529)
UL type rating	UL type 12 (acc. to UL 50E)
Temperature	-40°C to +140°C (static)
Properties	Halogen-free, silicone-free

### Compatible with

KEL-FA Cable entry frames	24 - 27
KEL Cable entry frames	28 - 37
KEL-U Cable entry frames	20 - 22
KEL-FG Flange enclosure	46 - 49
KEL-QUICK Cable entry frames	105 - 107
MP Module plates	314 - 315
BPK-SNAP Blank plates	332



Integrated circular sealing (IP54)



Blank plate BPK-SNAP, see page 332

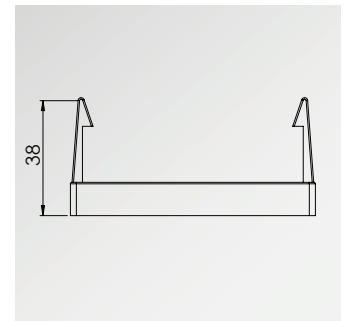

**i** Single-piece packaging units are available on request.

# KEL-SNAP

## Snap mounting frames



Description	Cut-out   Drilling template	Type	Cut-out [mm]	Suitable for	Order No.	PU
		KEL-SNAP-B	46 × 38	KEL-B KEL-U-B KEL-QUICK-B	42038	10
		KEL-SNAP 10	46 × 65	KEL 10 KEL-U 10 KEL-QUICK 10	42039	10
		KEL-SNAP 16	46 × 85	KEL 16 KEL-U 16 KEL-QUICK 16	42040	10
		KEL-SNAP 24	46 × 112	KEL 24 KEL-U 24 KEL-FG-A KEL-QUICK 24	42042	10
		KEL-SNAP 24-E	71 × 112	KEL 24-E	42044	1
		KEL-SNAP 24-MT	89 × 112	KEL 24-MT	42046	1

- 1
- 1.11
- 1.12
- 1.13
- 1.14
- 1.15
- 1.21
- 1.22
- 1.23
- 1.24
- 1.25
- 1.3

# KEL-JUMBO

Cable entry frames  
for supply cables

KTF, KTF-SCDP

Grommets for KEL-JUMBO



KTF

KTF-SCDP

The KEL-JUMBO cable entry system for installation of cables and conduits with a diameter of up to 65 mm, especially suited for supply cables.

The innovative grommet design with the flex-membrane provides flexing and adjustment of the position for larger and more rigid cables.

We recommend round cut-outs, which can be made using standard punching tools. Suggested cut-out: cable diameter +15–20%. All frame systems come with a rubber gasket.

The KTF grommets are suitable for cable diameters up to 65 mm.

The adaptable KTF-SCDP cable grommet enables the routing and sealing of supply cables and conduits with diameters up to 55 mm.

Cables with a comparatively smaller diameter can be utilised with KEL-JUMBO frames by using an adapter grommet.

### Advantages & benefits

- Installation of cables up to 65 mm
- KTF grommets allow flexing and adjustment of the cable position
- Retrofitting and maintenance can be carried out easily and quickly

### Specifications

Material	KEL-JUMBO: Polyamide (PA) KTF, KTF-SCDP: Elastomer
Flame class	UL 94 V-0, self-extinguishing
IP rating	IP54
UL type rating	UL type 12 (acc. to UL 50E)
Temperature	KEL-JUMBO: -40°C to +140°C (static) KTF, KTF-SCDP: -40°C to +100°C (static)
Properties	Halogen-free, silicone-free
Cut-out dimensions	Round (recommended)
Frame depth	35 mm

### Accessories

KDR-ESR Base plates	300 - 311
KDR2 Split base plates	312 - 313
MP Module plates	314 - 315

Type	Order No.	Clamping range	PU
KTF 00	42371	Blank grommet	1
KTA	42370	Adapter grommet for KT large	1
KTF 34	42376	33 – 36 mm	1
KTF 38	42379	37 – 40 mm	1
KTF 42	42382	41 – 44 mm	1
KTF 46	42385	45 – 48 mm	1
KTF 50	42388	48 – 52 mm	1
KTF 54	42391	53 – 56 mm	1
KTF 58	42394	56 – 60 mm	1
KTF 62	42397	61 – 65 mm	1
KTF-SCDP-A	42398	8 – 55 mm	1

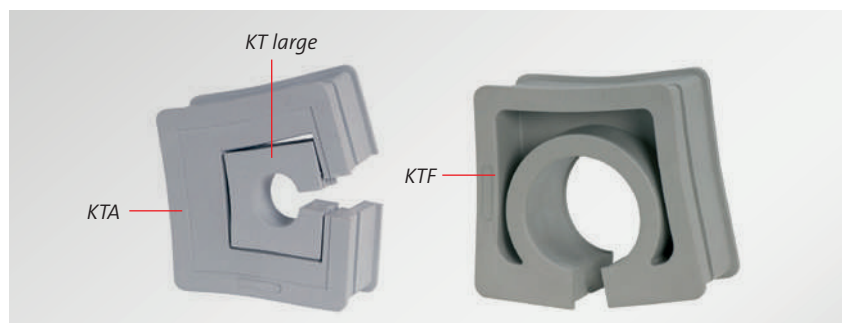



# KEL-JUMBO

## Cable entry frames for supply cables

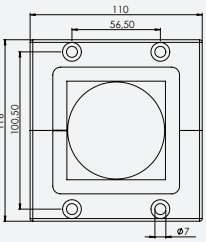
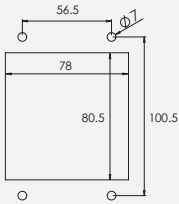
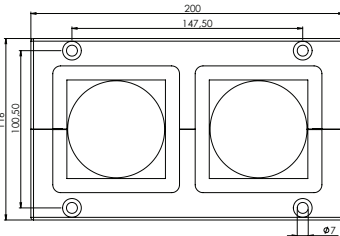
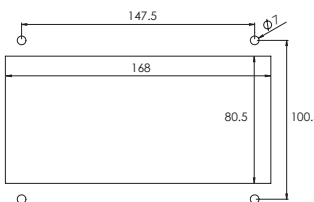

Description	Cut-out   Drilling template	Type	Order No.	Dimensions length   width   height	PU
		KEL-JUMBO 1	42360	110 × 116 × 35 mm	1
		KEL-JUMBO 1 with V2A screws	42360.200	110 × 116 × 35 mm	1
		KEL-JUMBO 2	42350	200 × 116 × 35 mm	1
		KEL-JUMBO 2 with V2A screws	42350.200	200 × 116 × 35 mm	1

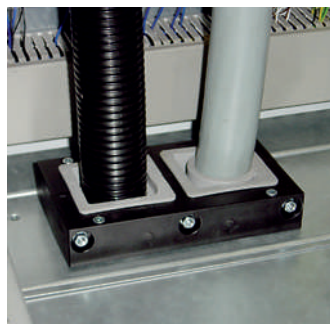
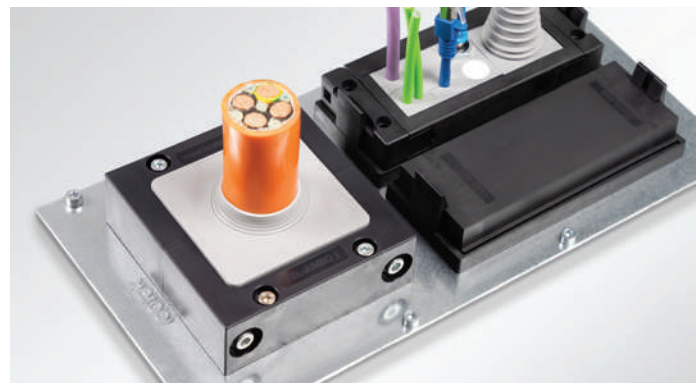

- 1
- 1.11
- 1.12
- 1.13
- 1.14
- 1.15
- 1.21
- 1.22
- 1.23
- 1.24
- 1.25
- 1.3

# 1.12 Split cable glands for the KT grommet system



By using icotek's split cable glands, cables with or without connectors or complete cable harnesses with diameters from 1 to 35 mm can be quickly routed into enclosures, cabinets or machines and achieve protection levels up to IP66/IP68/UL type 4X rated.

The split system of the KVT cable glands enables quick and easy assembly which is great for retrofitting and maintenance. The cable is placed into the split grommet which is set into one of the gland halves.

Depending on the size of the cable gland one, two, four or six separate grommets can be installed. The two gland halves can be easily snapped together without the need of tools. The routed lines are securely sealed and held inside the grommets.

To mount the cable gland, either snap it into the standard round metric cut-out (sizes available from M20 to M80) or screw it on with a hexagon locknut. The assembly method depends on the model used.

**Screwable or pluggable.**

By screwing the top section of the split cable gland to its body, a higher clamping pressure can be achieved (stainless steel screws by default).

**Split system**

**Fast and easy assembly**

For metric cut-outs M20 - M80

High cable density, wide variety in cable grommets

**Integrated seal**

Warranty on pre-terminated cables remains

Special locknuts for e.g. D-Sub or PROFIBUS connectors as well as split locknuts available.

Very good strain relief acc. to EN 62444 – no additional cable ties required!

**KVT-ER**

**IP68**



*KVT-ER 63/4 equipped with pressure compensation element, see page 100*

- 1
- 1.11
- 1.12
- 1.13
- 1.14
- 1.15
- 1.2
- 1.21
- 1.22
- 1.23
- 1.24
- 1.25
- 1.3



Split cable glands  
for screw-in assembly,  
M25 – M63,  
for cable diameters up to 35 mm

KVT-ER

60 – 61



Split cable glands  
for screw-in assembly,  
M20 – M63,  
for cable diameters up to 35 mm

KVT

62 – 63

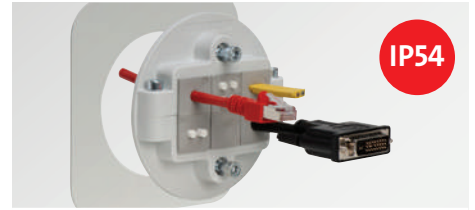

Split cable glands  
for screw-in assembly,  
M80,  
for cable diameters up to 35 mm

KVT 80

64



Split cable glands  
for snap-in assembly,  
M32 – M63,  
for cable diameters up to 35 mm

KVT-SNAP

65



Split cable glands  
for 90° cable transit,  
for screw-in assembly,  
M32 – M50,  
for cable diameters up to 35 mm

KVT-W90

66

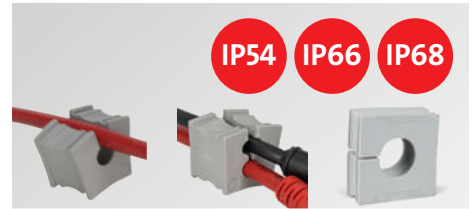

Cable grommets  
split and not split,  
for cables with/without connectors,  
for cable diameters 1 – 35 mm

74 – 89



IMAS-CONNECT™  
Modular adapter system  
for the KT system

90 – 101



Thread extension  
for cable glands and  
cable entry plates  
M32, M50, M63

TE-M

334 – 337

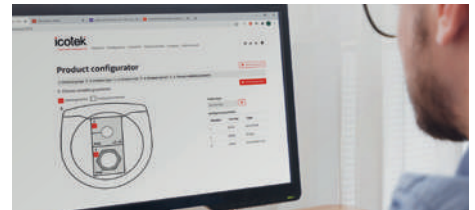

Product configurator  
[www.icotek.com/en/config](http://www.icotek.com/en/config)

67

1  
1.11  
1.12  
1.13  
1.14  
1.15  
1.2  
1.21  
1.22  
1.23  
1.24  
1.25  
1.3

# KVT-ER series

## Split cable glands

### with IP66/IP68 rating



KVT-ER are split cable glands for routing and sealing cables with connectors, with diameters from 1 to 16 mm (KT 1 – 15) and 16 to 35 mm (KT 16 – 34). But also electric, pneumatic or hydraulic lines without terminals or connectors as well as corrugated conduits can be easily routed (e.g. into control panels, enclosures or machinery), sealed and strain relieved acc. to EN 62444.

The KVT-ER sizes are based on metric standard cut-outs M25, M32, M50 and M63. Hexagonal locknuts are included in the shipment. For assembly, we recommend to tighten the cover lid screws with max. 2 Nm.

Due to the injected gasket and if single-hole grommets are used, the KVT-ER provides certified protection ratings IP66/IP68 and UL type 12 and 4X\*.

#### Advantages & benefits

- Very high strain relief according to EN 62444
- Maintain manufacturer's warranty on pre-terminated cables
- Retrofittings, repairs and maintenance can be done easily and quickly
- Suitable for metric cut-outs
- High cable density, wide variety of grommets
- Hexagonal lock nut included in the delivery
- V2A stainless steel screws
- Very robust housing, vibration resistant
- Modern design

#### Specifications

Material	Frame: Polypropylene (PP) Injected gasket: Elastomer
Flame class	UL 94 V-0, self-extinguishing
IP rating	IP65/IP66/IP67/IP68, if correctly assembled with single grommets (certified acc. to EN 60529)
Temperature	-40°C to +110°C (static)
Properties	Halogen-free, silicone-free
Cut-out dimension	Metric sizes

#### Accessories

KT Cable grommets	76 - 77
AT Adapter grommets	92 - 97
KVT-EMC Brackets	263
Locknuts	346
ST Plugs	85

 Single-piece packaging units are available on request.



Certified protection class IP65/  
IP66/IP67/IP68

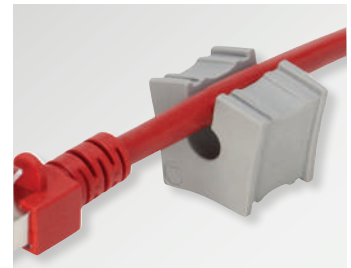

Split KT grommets



Injected elastomer gasket



Can be combined with TE-M thread  
extension



**KGM-SUB-D9**  
fits D-Sub 9 connectors  
(Required wall cut-out:  
diameter 36 mm, PU: 10)  
■ Order No. 45106

**KGM-SUB-D25**  
fits SUB-D25 connectors  
(Required wall cut-out:  
diameter 50 - 54 mm, PU:10)  
■ Order No. 45110

Type GMT: Split locknut, p. 346

# KVT-ER

## Split cable glands



Description	Type	Order No.	Grommets KT small   large	Cut-out** diameter	Thread Thread length	PU
	KVT-ER 25*	45450	1   -	25.5 mm	M25 × 1.5 Length: 18 mm	10
	KVT-ER 32	45452	1   -	32.5 mm	M32 × 1.5 Length: 18 mm	10
	KVT-ER 50 2	45454	2   -	50.5 mm	M50 × 1.5 Length: 18 mm	5
	KVT-ER 63 1	45455	-   1	63.5 mm	M63 × 1.5 Length: 18 mm	5
	KVT-ER 63 4	45456	4   -	63.5 mm	M63 × 1.5 Length: 18 mm	5

1  
1.11  
**1.12**  
1.13  
1.14  
1.15  
1.2  
1.21  
1.22  
1.23  
1.24  
1.25  
1.3

\* Max. cable diameter of 15 mm

\*\* Please consider any paint layers or powder coatings!

# KVT series

## Split cable glands with IP54 rating



KVT is a circular split frame for quick and easy installation and sealing of cables with connectors or complete cable harnesses.

Polyamide locknuts as well as a sealing ring are included in the shipment. For routing D-Sub, DVI or PROFIBUS connectors in combination with the split cable glands KVT, special locknuts with cut-outs are required.

### Advantages & benefits

- Insertion of pre-terminated cables
- Maintain manufacturer's warranty on pre-terminated cables
- Retrofittings, repairs and maintenance can be done much more easily and quickly
- High cable density, wide variety of grommets
- Suitable for metric cut-outs
- Locknut is included

### Specifications

Material	Polycarbonate (PC)
Colour	<input type="checkbox"/> grey (similar RAL 7035) <input type="checkbox"/> black
Flame class	UL 94 V-0, self-extinguishing
IP rating	IP54, with gasket and correct selection of the cable grommets (certified acc. to EN 60529)
UL type rating	UL type 12 (acc. to UL 50E)
Temperature	-30°C to +100°C (static)
Properties	Halogen-free, silicone-free
Cut-out dimension	Metric sizes

### Accessories

KT Cable grommets	74 - 89
AT Adapter grommets	90 - 101
KVT-EMC Brackets	263
Locknuts	346
ST Plugs	85

Description	Type	Order No.	Grommets small   large	Thread Thread length	PU
	KVT 20**	<input type="checkbox"/> 45034 <input type="checkbox"/> 45024	1 -	M20 × 1.5 Length: 14 mm	10
	KVT 25***	<input type="checkbox"/> 45035 <input type="checkbox"/> 45025	1 -	M25 × 1.5 Length: 14 mm	10
	KVT 32	<input type="checkbox"/> 45036 <input type="checkbox"/> 45026	1 -	M32 × 1.5 Length: 14 mm	10
	KVT 32 + KGM-SUB-D9	<input type="checkbox"/> 45037 <input type="checkbox"/> 45027	1 -	M32 × 1.5 Length: 14 mm	10

**i** Single-piece packaging units are available on request.

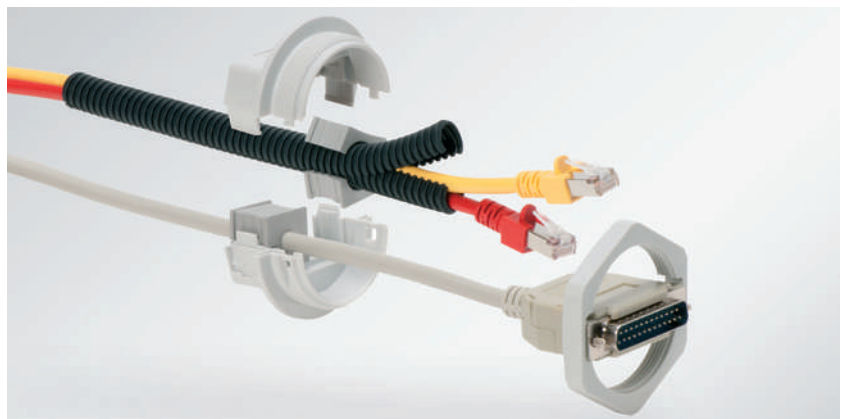

# KVT

## Split cable glands



### Locknuts

Locknuts with special cut-outs are available separately. The cut-out dimensions are listed on page 292.

**KGM-SUB-D9** fits D-Sub 9 connectors  
(Required wall cut-out:  $\varnothing$  36 mm, PU: 10)  
■ Order No. 45105 ■ Order No. 45106

**KGM-PB** fits DVI and PROFIBUS connectors  
(Required wall cut-out:  $\varnothing$  42 mm, PU: 10)  
■ Order No. 45107 ■ Order No. 45109

**KGM-SUB-D25** fits SUB-D25 connectors  
(Required wall cut-out:  $\varnothing$  50 - 54 mm, PU:10)  
■ Order No. 45108 ■ Order No. 45110

Description	Type	Order No.	Grommets small   large	Thread Thread length	PU
	KVT 40	■ 45203 ■ 45028	1 -	M40 x 1.5 Length: 14 mm	10
	KVT 40 + KGM-PB	■ 45205 ■ 45029	1 -	M40 x 1.5 Length: 14 mm	10
	KVT 50 2 *	■ 45204 ■ 45030	2 -	M50 x 1.5 Length: 14 mm	5
	KVT 50 2 * + KGM-SUB-D25	■ 45206 ■ 45031	2 -	M50 x 1.5 Length: 14 mm	5
	KVT 63 1	■ 45212 ■ 45112	- 1	M63 x 1.5 Length: 14 mm	5
	KVT 63 4	■ 45215 ■ 45115	4 -	M63 x 1.5 Length: 14 mm	5

**i** Single-piece packaging units are available on request.



Type GMT: Split locknut, p. 346



The cable glands enable the integration of the IMAS-CONNECT™ adapter grommets

1  
1.11  
**1.12**  
1.13  
1.14  
1.15  
1.2  
1.21  
1.22  
1.23  
1.24  
1.25  
1.3

# KVT 80

## Split cable glands for front mounting

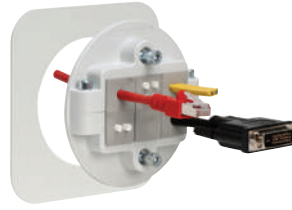

The KVT 80 split cable glands are designed for routing and sealing cables with connectors. By assembling the two frame halves with the screws provided, the grommets provide sufficient pressure on the routed cables to obtain a high degree of strain relief. The KVT 80 can be fitted to a wall thickness from 1.5 mm to 10 mm. A flat rubber gasket is included in the shipment.

### Advantages & benefits

- Insertion of pre-terminated cables
- Maintain manufacturer's warranty on pre-terminated cables
- Retrofittings, repairs and maintenance can be done much more easily and quickly
- High cable density, wide variety of grommets
- Fast and easy mounting from the front
- Strain relief according to EN 62444

### Note

When mounting the KVT 80 on sheet metal, we recommend the following torque values:  
1.5 mm sheet = 1 N m | 2 – 10 mm sheet = 1.5 N m

### Specifications

Material	Polycarbonate (PC)
Colour	■ grey (similar RAL 7035) ■ black
Flame class	UL 94 V-0, self-extinguishing
IP rating	IP54, with gasket and correct selection of the cable grommets (certified acc. to EN 60529)
UL type rating	UL type 12 (acc. to UL 50E)
Temperature	-30°C to +100°C (static)
Properties	Halogen-free, silicone-free
Cut-out dimension	80 mm in diameter

### Accessories

Cable grommets	74 - 89
ST Plugs	85

Description	Type	Order No.	Grommets KT small   large	PU
	KVT 80 3	■ 45236	2 1	1
		■ 45239		

	KVT 80 6	■ 45237	6 -	1
		■ 45238		

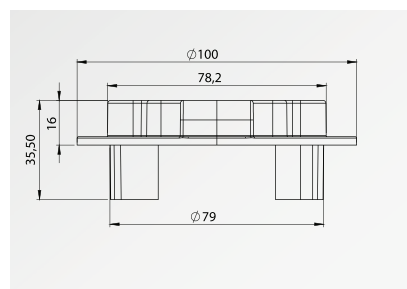



# KVT-SNAP

## Split pluggable cable glands



KVT is a circular split frame for quick and easy installation of cables with connectors or complete cable harnesses.

By using the model KVT-SNAP, cables can be routed through thick walls (> 5 mm) e.g. into cast terminal boxes without the use of tools. A sealing ring is included in the shipment.

### Assembly

- The snap ring is screwed into metric thread or tapped into the cut-out (it can also be fastened with a locknut, which is included in the shipment of KVT-SNAP 63)
- Once the snap ring is affixed to the housing the equipped KVT is simply pushed into it. Fast and easy installation!

### Specifications

Material	Polycarbonate (PC)
Colour	■ grey (similar RAL 7035)
Flame class	UL 94 V-0, self-extinguishing
IP rating	IP54, with gasket and correct selection of the cable grommets (certified acc. to EN 60529)
Temperature	-30°C to +100°C (static)
Properties	Halogen-free, silicone-free
Cut-out dimension	Metric cut-outs

### Accessories

Cable grommets	74 - 89
KVT-EMC Brackets	263
KGM Locknuts	346
ST Plugs	85

Description	Type	Order No.	Grommets small   large	Thread Thread length	PU
	KVT-SNAP 32	45130	1 -	M32 × 1.5 Length: 11 mm	10
	KVT-SNAP 40	45134	1 -	M40 × 1.5 Length: 11 mm	10
	KVT-SNAP 63 4 + KGM 63	45152	4 -	M63 × 1.5 Length: 11 mm	5
	KVT-SNAP 63 1 + KGM 63	45154	- 1	M63 × 1.5 Length: 11 mm	5
	KGM 32	■ 52275 ■ 52285	PA	M32 × 1.5	10
	KGM 40	■ 52276 ■ 52286	PA	M40 × 1.5	10
	KGM 63	■ 52278 ■ 52288	PA	M63 × 1.5	5

Single-piece packaging units are available on request.



\* Only valid for grey product types

# KVT-W90

for 90° cable transit,  
split cable glands



The split KVT-W90 cable glands are used to insert and seal pre-terminated cables and conduits at a 90° angle. In particular, the KVT 50-W90 is perfectly suited to hold corrugated or smooth hoses. A large number of cable entry grommets is available to the user.

Polyamide standard locknuts as well as a sealing ring are included in the shipment. Split locknuts can be ordered separately.

### Advantages & benefits

- Installation at an angle of 90° to the cabinet
- Insertion of pre-terminated cables and conduits
- Maintain manufacturer's warranty on pre-terminated cables
- Suitable for metric cut-outs

### Specifications

Material	Polycarbonate (PC)
Colour	<input type="checkbox"/> grey (similar RAL 7035) <input type="checkbox"/> black
Flame class	UL 94 V-0, self-extinguishing
IP rating	IP54, with gasket and correct selection of the cable grommets (certified acc. to EN 60529)
Temperature	-30°C to +100°C (static)
Properties	Halogen-free, silicone-free
Cut-out dimension	Metric cut-outs

### Accessories

Cable grommets	74 - 89
KVT-EMC Brackets	263
KGM Locknuts	346
ST Plugs	85

Description	Type	Order No. with locknut	Grommets small   large	Thread Thread length	PU
	KVT 32-W90	<input type="checkbox"/> 45404 <input type="checkbox"/> 45406	1 -	M32 × 1.5 Length: 11.5 mm	10
	KVT 50 4-W90	<input type="checkbox"/> 45424 <input type="checkbox"/> 45426	4 -	M50 × 1.5 Length: 11.5 mm	5
	KVT 50 1-W90	<input type="checkbox"/> 45414 <input type="checkbox"/> 45416	- 1	M50 × 1.5 Length: 11.5 mm	5

Single-piece packaging units are available on request.





# The practical product configurator

With the product configurator, you can now assemble your cable entry system with the required cable or adapter grommets.

Check it out: [www.icotek.com/en/config](http://www.icotek.com/en/config)

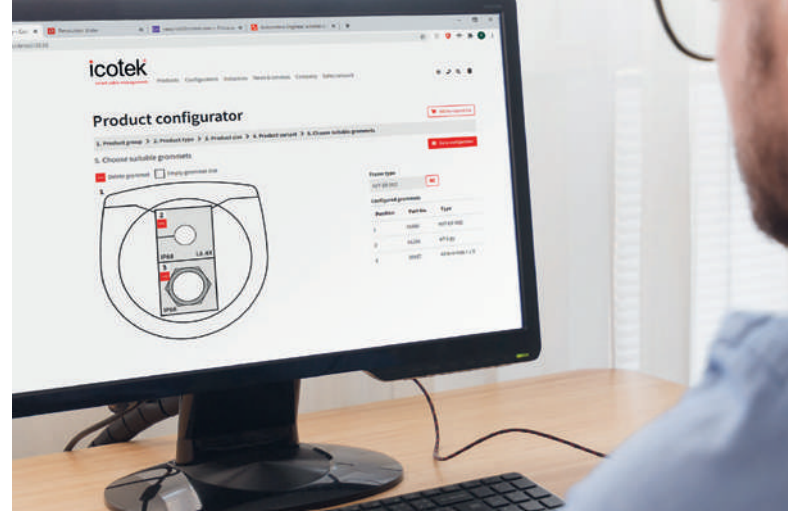

### Product configurator

1. Product group > 2. Product type > 3. Product size > 4. Product variant > 5. Choose suitable grommets

1. Choose product group

**Cable entry frames for cables with connectors**

Using the patented grommet based icotek KEL cable entry system, pre-terminated as well as standard cables without connectors can be routed into switch cabinets, control panels or machines. The cables are also sealed (up to IP66 / UL type 4x) and strain relieved.

**Select**

**Cable glands for cables with connectors**

By using split cable glands by icotek pre-terminated cables with diameters from 1 to 35 mm can be quickly routed into enclosures, control panels or machines and be sealed with up to IP66 / IP68 / UL type 4x rated ingress protection (certified according to EN 30520 / UL50-E). In addition, the cable glands serve as strain reliefs on the cable. The split cable glands enable quick and easy assembly which is great for retrofits and maintenance.

**Select**

**EMC cable entry systems**

In case of conducted as well as field bound EMI disturbances, our split EMC cable entry systems offers an effective way to divert and block those disturbances and provides an economic alternative to expensive EMC cable glands.

**Select**

### Product configurator

1. Product group > 2. Product type > 3. Product size > 4. Product variant > 5. Choose suitable grommets

4. Choose product type

**KEL-U 16/8**

**Mounting options:** Snap-in with KEL-SNAP  
Screw type mounting  
**Classification:** IP54, UL Type 12  
**Max. cable diameter:** 17 mm  
**Length:** 120 mm  
**Width:** 58 mm  
**Height:** 17 mm  
**Max. cut-out width:** 36 mm  
**Max. cut-out length:** 86 mm

**Select**

**KEL-U 16/8 V2A**

**Mounting options:** Snap-in with KEL-SNAP  
Screw type mounting  
**Classification:** IP54, UL Type 12  
**Max. cable diameter:** 17 mm  
**Length:** 120 mm  
**Width:** 58 mm  
**Height:** 17 mm  
**Max. cut-out width:** 36 mm  
**Max. cut-out length:** 86 mm

**Select**

**KEL-U 16/5**

**Mounting options:** Snap-in with KEL-SNAP  
Screw type mounting  
**Classification:** IP54, UL Type 12  
**Max. cable diameter:** 35 mm  
**Length:** 120 mm  
**Width:** 58 mm  
**Height:** 17 mm  
**Max. cut-out width:** 36 mm  
**Max. cut-out length:** 86 mm

**Select**

### Product configurator

1. Product group > 2. Product type > 3. Product size > 4. Product variant > 5. Choose suitable grommets

5. Choose suitable grommets

Delete grommet  Empty grommet slot

Image	Part No.	Type	Select		
	KT 7 gy	7 - 8 mm	KT small	Round cable	<b>Select</b>
	KT 8 gy	8 - 9 mm	KT small	Round cable	<b>Select</b>
	KT 9 gy	9 - 10 mm	KT small	Round cable	<b>Select</b>
	KT oval gy	-	KT small	-	<b>Select</b>
	KT tela gy	-	KT small	Telephone cable	<b>Select</b>

### Product configurator

1. Product group > 2. Product type > 3. Product size > 4. Product variant > 5. Choose suitable grommets

5. Choose suitable grommets

Delete grommet  Empty grommet slot

**Frame type:** KEL-U 16/5

Position	Part No.	Type
1	54185	KEL-U 16/5
2	41208	KT 8 gy
3	41210	KT 10 gy
4	41209	KT 9 gy
5	39956	AT-K-M M12 x 1,5

### Product configurator

1. Product group > 2. Product type > 3. Product size > 4. Product variant > 5. Choose suitable grommets

5. Choose suitable grommets

Delete grommet  Empty grommet slot

Image	Part No.	Type	Select	
	AT-K5	-	IMAS-CONNECT Adaptertülle groß	<b>Select</b>
	AT-M 12 x 1.0	M12 x 1,0	IMAS-CONNECT Adaptertülle groß	<b>Select</b>
	AT-M 16 x 1.5	M16 x 1,5	IMAS-CONNECT Adaptertülle groß	<b>Select</b>
	AT-M 20 x 1.5	M20 x 1,5	IMAS-CONNECT Adaptertülle groß	<b>Select</b>
	AT-M 25 x 1.5	M25 x 1,5	IMAS-CONNECT Adaptertülle groß	<b>Select</b>

### Product configurator

1. Product group > 2. Product type > 3. Product size > 4. Product variant > 5. Choose suitable grommets

5. Choose suitable grommets

Delete grommet  Empty grommet slot

**Frame type:** KEL-U 16/5

Position	Part No.	Type
1	54185	KEL-U 16/5
2	41208	KT 8 gy
3	41210	KT 10 gy
4	41209	KT 9 gy
5	39956	AT-K-M M12 x 1,5
6	39952	AT-K5

- 1
- 1.11
- 1.12
- 1.13
- 1.14
- 1.15
- 1.2
- 1.21
- 1.22
- 1.23
- 1.24
- 1.25
- 1.3

## 1.13 Distribution Box for 360° cable entry

The 360° cable entry  
for cables with and without connectors



**With the distribution box, centrally routed cables can be distributed 360° in any direction.**

Cables with and without connectors can be routed, sealed with IP54 (certified according to DIN EN 60529) and at the same time strain-relieved according to DIN EN 62444.

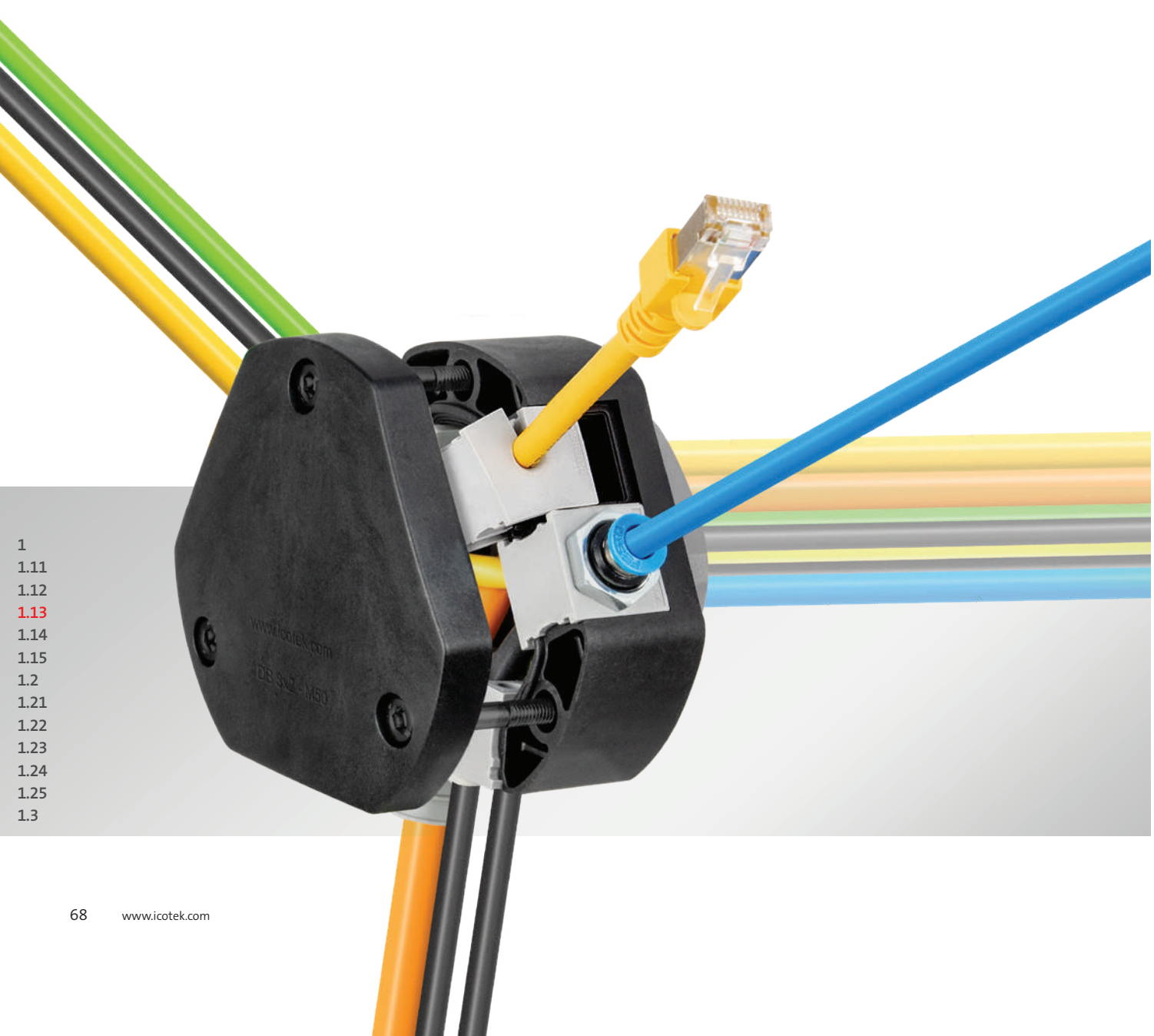

- 1
- 1.11
- 1.12
- 1.13
- 1.14
- 1.15
- 1.2
- 1.21
- 1.22
- 1.23
- 1.24
- 1.25
- 1.3

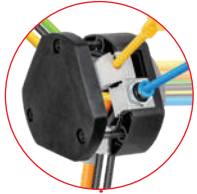

Easy distribution of cables in a 360° angle



Innovative design

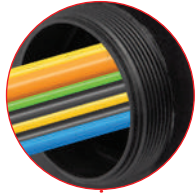

Metric thread, suitable for metric cut-outs M32 – M75



Material Polyamide, Polypropylene

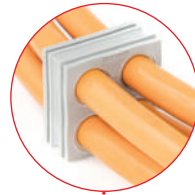

High cable density, wide variety of grommets



Hexagonal locknut included in the delivery

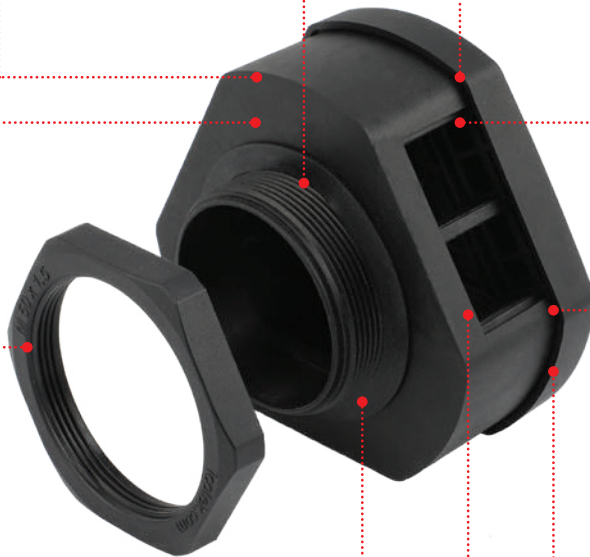

Strain relief according to EN 62444

Separate flat gasket included in the delivery

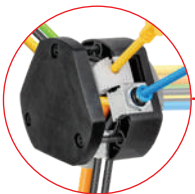

Use of the proven KT grommet system as well as IMAS-CONNECT™ adapter grommets

Screw-on cover, captive screws



- 1
- 1.11
- 1.12
- 1.13**
- 1.14
- 1.15
- 1.2
- 1.21
- 1.22
- 1.23
- 1.24
- 1.25
- 1.3

# DB Distribution Box

360° cable entry  
with IP54 rating



With the new distribution box, centrally routed cables can be distributed 360° in any direction.

Cables with and without connectors can be routed, sealed with IP54 (certified according to DIN EN 60529) and at the same time strain-relieved according to DIN EN 62444. Up to 48 cables can be routed and a very high cable density achieved by using multiple grommets.

The basic triangular shape provides maximum space for cable entry. This allows the use of cables with different bending radii.

The distribution box fits standard metric cut-outs M32 – M75 and is secured with a locknut which is included in the delivery. The screw-on cover and the use of split cable grommets make it easy to retrofit or service at a later date.

## Advantages

- Fast and easy assembly
- Easy distribution of cables in a 360° angle
- Warranty on pre-terminated cables remains
- Retrofittings, repairs and maintenance can be done much more easily and quickly
- Suitable for metric cut-outs M32 – M75
- Strain relief according to EN 62444
- Use of the proven KT grommet system
- High cable density, wide variety of grommets
- High flexibility with the use of multi-range and IMAS-CONNECT™ adapter grommets
- Hexagonal locknut included in the delivery
- High stability, vibration resistant
- Mechanical protection of the central entry point
- Captive screws

## Specifications

Material	Polyamide (PA), Polypropylene (PP)
Flame class	UL 94 V-0, self-extinguishing
IP rating	IP54 (certified acc. to EN 60529)
Temperature	-40°C to +110°C (static)
Properties	Halogen-free, silicone-free
Frame depth	39,4 mm

## Accessories

KT cable grommets	74 - 89
IMAS-CONNECT adapter grommets	90 - 101
TE-M	334 - 337

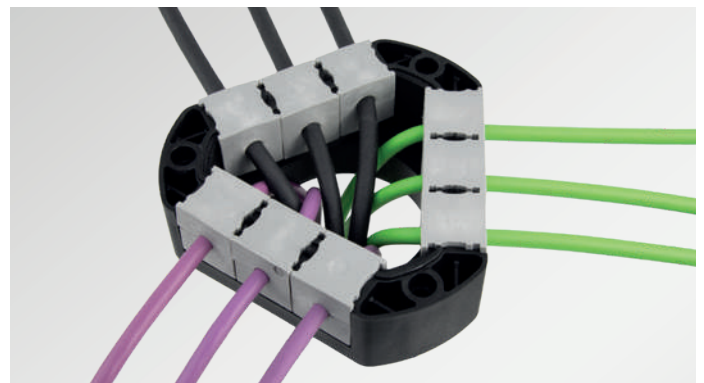
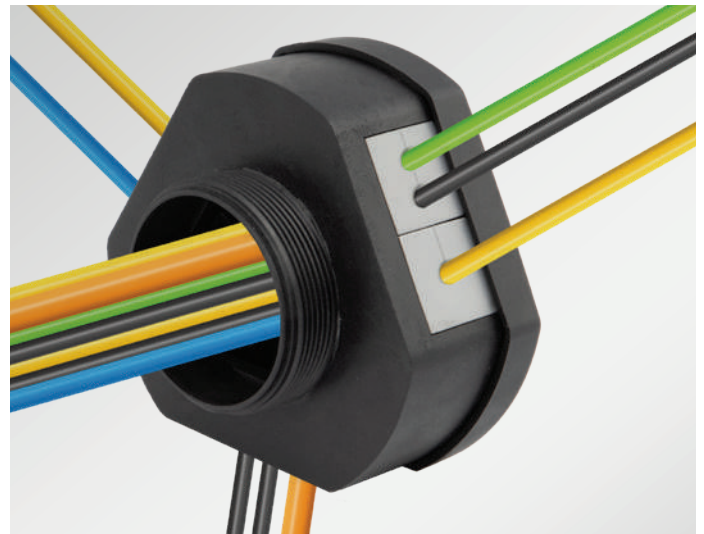
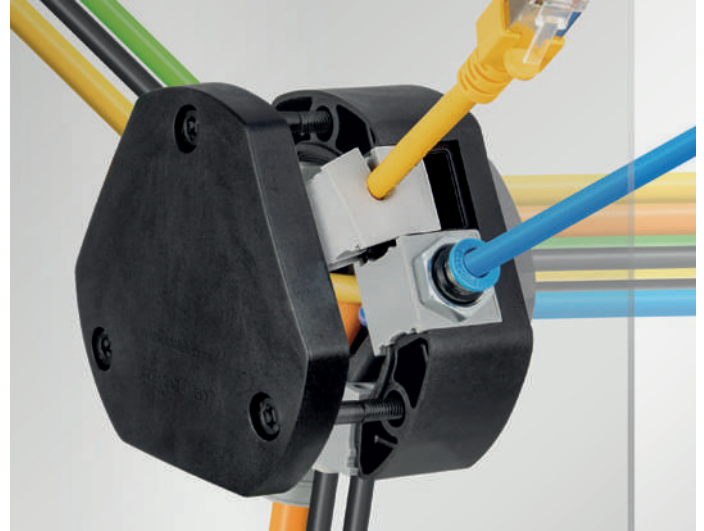

# DB Distribution Box

## 360° cable entry



Type	Grommets small	For max. no. of cables	Cut-out	Thread length	Dimensions L x B	Mounting height	Order No.	PU
DB 3x1   M32	3	12	M32	13,6 mm	72 x 67 mm	39,4 mm	54300	5
DB 3x2   M50	6	24	M50	13,6 mm	94,5 x 87 mm	39,4 mm	54301	5
DB 3x3   M63	9	36	M63	13,6 mm	115 x 104 mm	39,4 mm	54302	1
DB 3x4   M75	12	48	M75	13,6 mm	140 x 125 mm	39,4 mm	54303	1

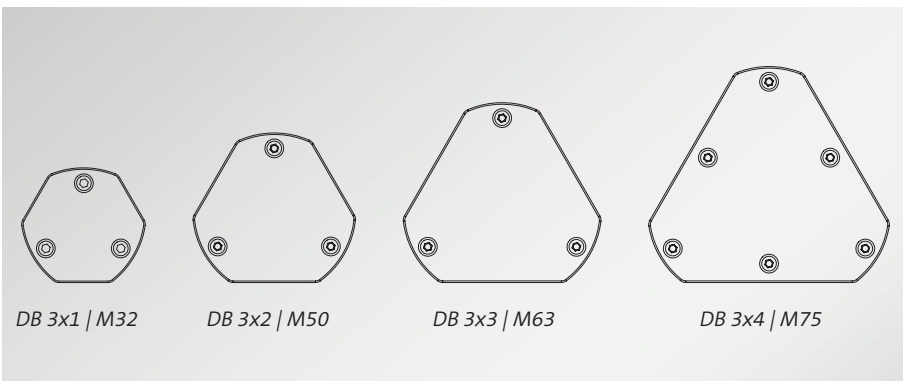

- 1
- 1.11
- 1.12
- 1.13**
- 1.14
- 1.15
- 1.2
- 1.21
- 1.22
- 1.23
- 1.24
- 1.25
- 1.3

## 1.14 Cable grommets for the KT system

Cable grommets KT are used with the following cable entry components:

- KEL cable entry frames
- KVT split cable glands
- DB Distribution Box

In combination with KEL-ER cable entry frames and KVT-ER cable glands the KT single-hole grommets enable a sealing of the cables with up to IP66/IP68 and UL Type 4X.

In principle, there are two types of cable grommets: split and non-split grommets. The split grommets are suitable for routing cables with connectors, the non-split ones are used for routing non-terminated cables.

Electrical, pneumatic or hydraulic lines as well as corrugated conduits and hoses can be easily routed, sealed and strain relieved using split cable entry systems.

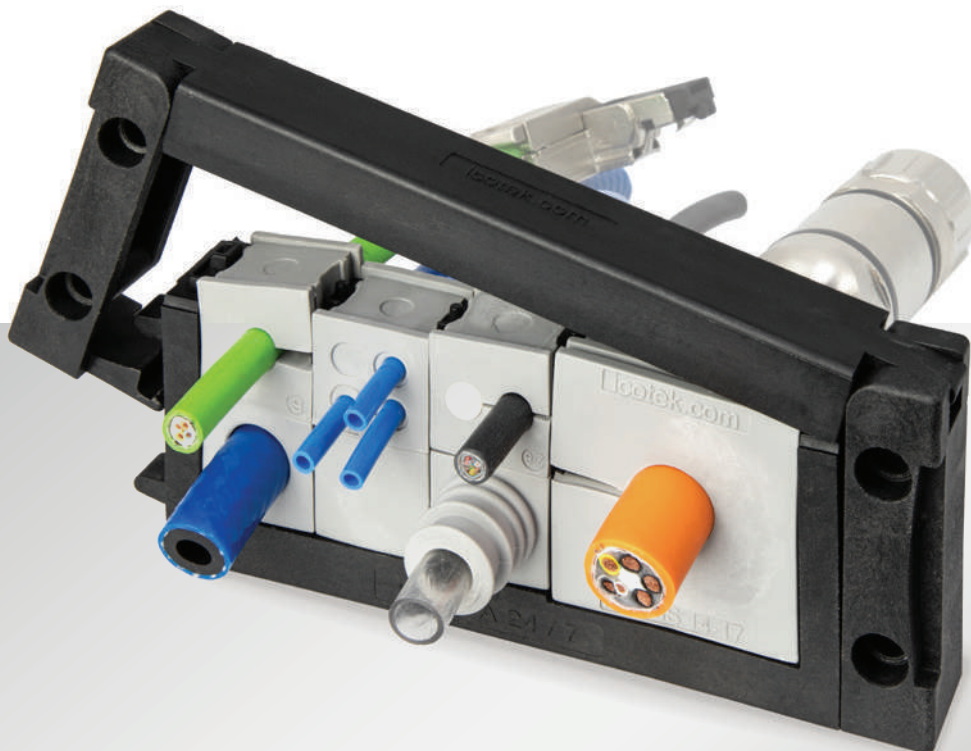
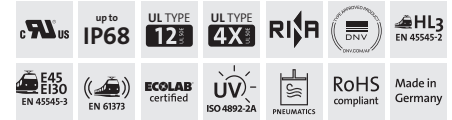

1  
1.11  
1.12  
1.13  
1.14  
1.15  
1.2  
1.21  
1.22  
1.23  
1.24  
1.25  
1.3



## Overview of cable entry systems and matching grommets

Product	Split cable grommets for cables with connectors				Non-split cable grommets for cables without connectors			
	KT small single-hole	KT large single-hole	KT small multi, special	KTMB multi-range	KT-DPF multi-range	KT-SC multi-range	KTMB multi-range	KT-DT
KEL-ER	●	●	●	●	●	●	●	●
KEL-U	●	●	●	●	●	●	●	●
KEL-FA	●	●	●	●	●	●	●	●
KEL	●	●	●	●	●	●	●	●
KEL-FG-ER	●	●	●	●	●	●	●	●
KEL-FG	●	●	●	●	●	●	●	●
KEL-FW	●	●	●	●	●	●	●	●
KVT-ER	●	●	●	●	●	●	●	●
KVT	●	●	●	●	●	●	●	●
KVT 80	●	●	●	●	●	●	●	●
KVT-SNAP	●	●	●	●	●	●	●	●
KVT W90	●	●	●	●	●	●	●	●
DB	●	–	●	●	●	●	●	●

● Not recommended, as the degree of protection would be reduced to IP54

1  
1.11  
1.12  
1.13  
1.14  
1.15  
1.2  
1.21  
1.22  
1.23  
1.24  
1.25  
1.3

## 1.14 Cable grommets for the KT system

### Split cable grommets for cables with connectors

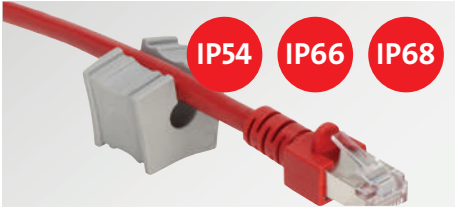

**Split cable grommets, single**  
Protection up to IP66/IP68 and UL Type 4X  
for cable diameters 1 to 35 mm

KT

76 – 77

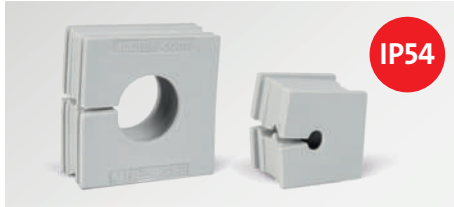

**Split multi-range cable grommets**  
IP54 protection and UL Type 12  
for cable diameters 4 to 29 mm

KTMB

78 – 79



**Split cable grommets, multi and special**  
IP54 protection and UL Type 12  
for cable diameters 1 to 8 mm

KT multi

80

### Non-split cable grommets for cables without connectors



**Multi-range cable grommets**  
IP54 protection  
for cable diameters 3 to 26 mm

KT-DPF

81



**Multi-range cable grommets**  
IP54 protection  
for cable diameters 4 to 28 mm

KT-SC

82

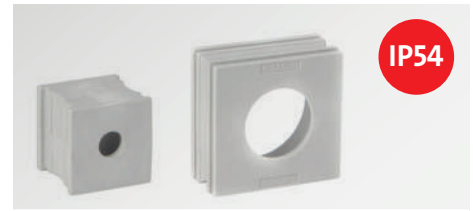

**Multi-range cable grommets**  
IP54 protection  
for cable diameters 2.5 to 33 mm

KTMB

83



**Membrane cable grommets**  
IP54 protection, high cable density  
for cable diameters up to 14.5 mm

KT-DT

844

## Plugs for cable grommets



**Plugs and cover plugs**  
Plugs for cable grommets,  
Cover plugs for cable entry frames

85 – 86



**Plugs for membranes**

ST-B

171

## IMAS-CONNECT™



**IMAS-CONNECT™**  
Modular adapter system  
for the KT system

90 – 101

## KT ServiceBox



**KT Servicebox**  
Service box for cable grommets

87



**KT Servicebox**  
Service box for cable grommets

88 – 89

- 1
- 1.11
- 1.12
- 1.13
- 1.14
- 1.15
- 1.2
- 1.21
- 1.22
- 1.23
- 1.24
- 1.25
- 1.3

# KT

## Split cable grommets, small, single



Split cable grommets KT are used with the following cable entry components:

- KEL cable entry frames
- KVT split cable glands
- DB Distribution Box

They are designed for cable diameters from 1 to 17 mm. Blank grommets can seal unused grommet spaces.

When installing the small grommets in multiple rows, the flat sides should be facing each other. This allows the flat sides to match up and provide a secure seal.

### Advantages

- Routing of cables with and without connectors
- High degree of protection up to IP68
- High strain relief in accordance with EN 62444 when a suitable cable entry is selected
- Available for a wide range of cable diameters

### Specifications KT grey

Material	Elastomer
Flame class	UL 94 V-0, self-extinguishing
IP rating	up to IP66/IP68
UL type rating	up to UL type 4X (acc. to UL 50E)
Temperature	- 40°C to + 100°C (static)
Properties	Halogen-free, silicone-free

### Specifications KT black

Material	Elastomer
Flame class	UL 94 HB
IP rating	up to IP66/IP68
Temperature	- 30°C to + 90°C (static)
Properties	Silicone-free Higher chemical resistance e.g. with aggressive oils, coolants

### Accessories

ST Plugs 85

Description	Type	Clamping range	IP rating	Compatible ST plugs	Order No grey	Order No black	PU
	KT 1	1 – 2 mm	IP68	ST 1	39941	39943	10
	KT 2	2 – 3 mm	IP68	ST 2	39934	41302	10
	KT 3	3 – 4 mm	IP68	ST 3	41203	41303	10
	KT 4	4 – 5 mm	IP68	ST 4	41204	41304	10
	KT 5	5 – 6 mm	IP68	ST 5	41205	41305	10
	KT 6	6 – 7 mm	IP68	ST 6	41206	41306	10
	KT 7	7 – 8 mm	IP68	ST 7	41207	41307	10
	KT 8	8 – 9 mm	IP68	ST 8	41208	41308	10
	KT 9	9 – 10 mm	IP68	ST 9	41209	41309	10
	KT 10	10 – 11 mm	IP68	ST 10	41210	41310	10
	KT 11	11 – 12 mm	IP68	ST 11	41211	41311	10
	KT 12	12 – 13 mm	IP68	ST 12	41212	41312	10
	KT 13	13 – 14 mm	IP68	ST 13	41213	41313	10
	KT 14	14 – 15 mm	IP68	ST 14	41214	41314	10
	KT 15	15 – 16 mm	IP68	ST 15	41215	41315	10
	KTs 16	16 mm	IP54	ST 16	39901	39912	10
	KTs 17	17 mm	IP54	ST 17	39900	39913	10
	BTK	Blank grommet	IP68	–	41251	41351	10

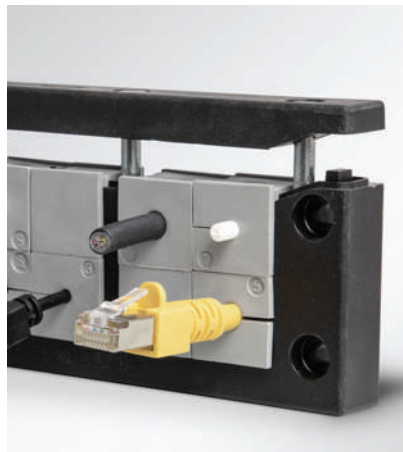

# KT

## Split cable grommets, large, single

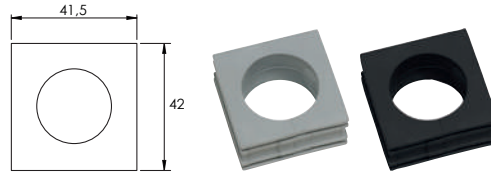

Split cable grommets KT are used with the following cable entry components:

- KEL cable entry frames
- KVT split cable glands

They are designed for cable diameters from 13 to 35 mm.

The adapter grommet ATG offers the possibility to accommodate a small cable grommet KT and thus reduce the clamping range down to 1 mm.

### Advantages







- Routing of cables with and without connectors
- High degree of protection up to IP68
- High strain relief in accordance with EN 62444 when a suitable cable entry is selected
- Available for a wide range of cable diameters

### Specifications KT grey

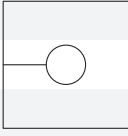
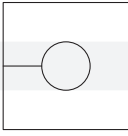
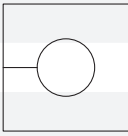
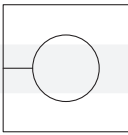
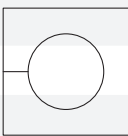
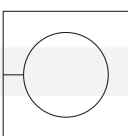
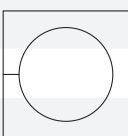
Material	Elastomer
Flame class	UL 94 V-0, self-extinguishing
IP rating	KT round, single: up to IP66/IP68 ATG/BTG: IP54
UL type rating	up to UL type 4X (acc. to UL 50E)
Temperature	-40°C to +100°C (static)
Properties	Halogen-free, silicone-free

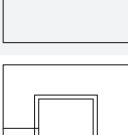
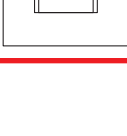
### Specifications KT black

Material	Elastomer
Flame class	UL 94 HB
IP rating	KT round, single: up to IP66/IP68 ATG/BTG: IP54
Temperature	-30°C to +90°C (static)
Properties	Silicone-free Higher chemical resistance e.g. with aggressive oils, coolants

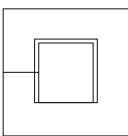
Description	Type	Clamping range	IP rating	Compatible ST plugs	Order No grey	Order No black	PU
	KTG 13	13 – 14 mm	IP68	ST 13	41263	41363	10
	KTG 14	14 – 15 mm	IP68	ST 14	41264	41364	10
	KTG 15	15 – 16 mm	IP68	ST 15	41265	41365	10
	KT 16	16 – 17 mm	IP68	ST 16	41216	41316	10
	KT 17	17 – 18 mm	IP68	ST 17	41217	41317	10
	KT 18	18 – 19 mm	IP68	ST 18	41218	41318	10
	KT 19	19 – 20 mm	IP68	ST 19	41219	41319	10
	KT 20	20 – 21 mm	IP68	ST 20	41220	41320	10
	KT 21	21 – 22 mm	IP68	ST 21	41221	41321	10
	KT 22	22 – 23 mm	IP68	ST 22	41222	41322	10
	KT 23	23 – 24 mm	IP68	ST 23	41223	41323	10
	KT 24	24 – 25 mm	IP68	ST 24	41224	41324	10
	KT 25	25 – 26 mm	IP68	ST 25	41225	41325	10
	KT 26	26 – 27 mm	IP68	ST 26	41226	41326	10
	KT 27	27 – 28 mm	IP68	ST 27	41227	41327	10
	KT 28	28 – 29 mm	IP68	ST 28	41228	41328	10
	KT 29	29 – 30 mm	IP68	ST 29	41229	41329	10
	KT 30	30 – 31 mm	IP68	ST 30	41230	41330	10
	KT 31	31 – 32 mm	IP68	ST 31	41231	41331	10
	KT 32	32 – 33 mm	IP68	ST 32	41232	41332	10
	KT 33	33 – 34 mm	IP68	ST 33	41233	41333	10
	KT 34	34 – 35 mm	IP68	ST 34	41234	41334	10
	BTG	Blank grommet	IP68	–	41252	41352	10
	ATG	Adapter grommet	IP54	–	41253	41353	10

1  
1.11  
1.12  
1.13  
**1.14**  
1.15  
1.2  
1.21  
1.22  
1.23  
1.24  
1.25  
1.3

# KTMB5

## Split multi-range grommets, small



Cable grommets KTMB5 are used to route cables with and without connectors with the following cable entry components:

- KEL cable entry frames (KEL-U, KEL, KEL-FA, KEL-FG)
- KVT cable glands
- DB Distribution Box

The innovative membrane enables the routing of cables with diameters that can vary up to 3 mm.

The KTMB5 small allows for the routing of cable diameters from 4 to 12 mm.

The innovative wave cut and the flexible sealing lips make it possible to seal the cable with IP54/UL Type 12.

### Advantages

- Routing of cables with and without connectors
- IP rating IP54
- Strain relief when a suitable cable entry is selected
- Large clamping range
- Only 4 grommets cover a clamping range from 4 to 12 mm
- Innovative wave cut for a better sealing
- Innovative membrane for high flexibility

### Specifications KT grey

Material	Elastomer
Flame class	UL 94-V0, self-extinguishing
IP rating	IP54
Temperature	-40°C to +100°C (static)
Properties	Silicone free, halogen free

### Specifications KT black

Material	Elastomer
Flame class	UL 94 HB
IP rating	IP54
Temperature	- 30°C to + 90°C (static)
Properties	Silicone-free Higher chemical resistance e.g. with aggressive oils, coolants

Description	Type	Clamping range	Compatible ST-B plugs	Order No grey	Order No black	PU
	KTMB5 4-7	4 – 7 mm	ST-B 6	41380	<b>NEW</b> 51380	10
	KTMB5 6-9	6 – 9 mm	ST-B 8	41381	<b>NEW</b> 51381	10
	KTMB5 8-11	8 – 11 mm	ST-B 10	41382	<b>NEW</b> 51382	10
	KTMB5 10-12	10 – 12 mm	ST-B 11	41383	<b>NEW</b> 51383	10



**i** ST-B plug for the sealing of the perforated membrane



Detail of the wave cut



Also available in black

# KTMB5

## Split multi-range grommets, large



Cable grommets KTMB5 are used to route cables with and without connectors with the following cable entry components:

- KEL cable entry frames (KEL-U, KEL, KEL-FA, KEL-FG)
- KVT cable glands

The innovative membrane enables the routing of cables with diameters that can vary up to 3 mm.

The KTMB5 large allows for the routing of cable diameters from 12 to 29 mm.

The innovative wave cut and the flexible sealing lips make it possible to seal the cable with IP54/UL Type 12.

### Advantages

- Routing of cables with and without connectors
- IP54 rating
- Strain relief when a suitable cable entry is selected
- Large clamping range
- Only 8 grommets cover a clamping range from 12 to 29 mm
- Innovative wave cut for a better sealing
- Innovative membrane for high flexibility

### Specifications KT grey

Material	Elastomer
Flame class	UL 94-V0, self-extinguishing
IP rating	IP54
Temperature	-40°C to +100°C (static)
Properties	Silicone free, halogen free

### Specifications KT black

Material	Elastomer
Flame class	UL 94 HB
IP rating	IP54
Temperature	- 30°C to + 90°C (static)
Properties	Silicone-free Higher chemical resistance e.g. with aggressive oils, coolants

Description	Type	Clamping range	Compatible ST-B plugs	Order No grey	Order No black	PU
	KTMB5 12-15	12 – 15 mm	ST-B 14	41384	<b>NEW</b> 51384	10
	KTMB5 14-17	14 – 17 mm	ST-B 16	41385	<b>NEW</b> 51385	10
	KTMB5 16-19	16 – 19 mm	ST-B 18	41386	<b>NEW</b> 51386	10
	KTMB5 18-21	18 – 21 mm	ST-B 20	41387	<b>NEW</b> 51387	10
	KTMB5 20-23	20 – 23 mm	ST-B 22	41388	<b>NEW</b> 51388	10
	KTMB5 22-25	22 – 25 mm	ST-B 24	41389	<b>NEW</b> 51389	10
	KTMB5 24-27	24 – 27 mm	ST-B 26	41390	<b>NEW</b> 51390	10
	KTMB5 26-29	26 – 29 mm	ST-B 28	41391	<b>NEW</b> 51391	10

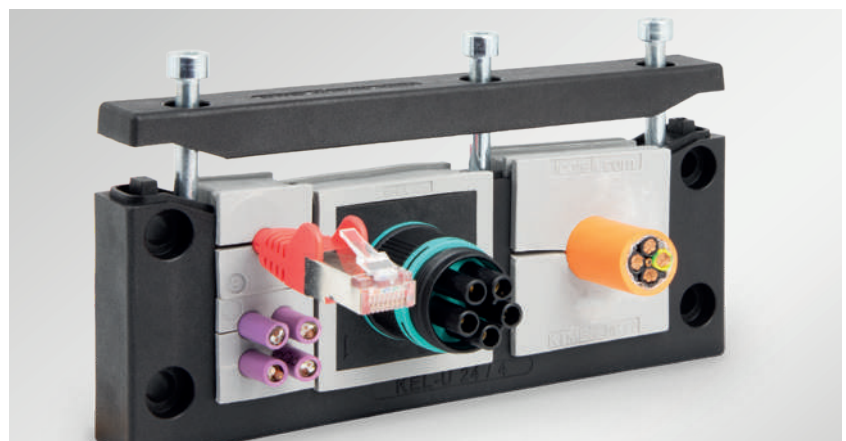

- 1
- 1.11
- 1.12
- 1.13
- 1.14**
- 1.15
- 1.2
- 1.21
- 1.22
- 1.23
- 1.24
- 1.25
- 1.3

# KT

## Split cable grommets, small, multi and special



Split cable grommets KT are used with the following cable entry components:

- KEL cable entry frames
- KVT split cable glands
- DB Distribution Box

KT multi-hole and special grommets enable a sealing of the cables with IP54 and UL Type 12.

When using double or quadruple grommets the cable density of cable entry frames and cable glands can be greatly increased. The multi-hole model range KT small is designed for cable diameters from 1 to 8 mm. icotek also offers special cable grommets for e.g. ASI lines. ATG adapter grommets provide the possibility to hold a small KT grommet to reduce the clamping range down to 1 mm.

When installing the small grommets in multiple rows, the flat sides should be facing each other. This allows the flat sides to match up and provide a secure seal.

### Advantages

- Routing of pre-assembled cables through cable entry frames and split cable glands
- IP rating IP54
- Greatly increased cable density when using double or quadruple grommets
- High strain relief in accordance with EN 62444 when a suitable cable entry is selected
- Available for a wide range of cable diameters

### Specifications KT grey

Material	Elastomer
Flame class	UL 94 V-0, self-extinguishing
IP rating	IP54
UL type rating	up to UL type 12 (acc. to UL 50E)
Temperature	- 40°C to + 100°C (static)
Properties	Halogen-free, silicone-free

### Specifications KT black

Material	Elastomer
Flame class	UL 94 HB
IP rating	IP54
Temperature	- 30°C to + 90°C (static)
Properties	Silicone-free Higher chemical resistance e.g. with aggressive oils, coolants

Description	Type	Order No grey	Order No black	Clamping range	PU	
	KT 2 1	39942	39944	2 × ø 1 mm	10	
	KT 2 2	39935	39936	2 × ø 2 mm	10	
	KT 2 3	39939	39940	2 × ø 3 mm	10	
	KT 2 4	39906	39907	2 × ø 4 mm	10	
	KT 2 5	41200	39904	2 × ø 5 mm	10	
	KT 2 6	41201	39905	2 × ø 6 mm	10	
	KT 2 7	41202	39916	2 × ø 7 mm	10	
	KT 2 8	39917	39918	2 × ø 8 mm	10	
	KT 4 2	39937	39938	4 × ø 2 mm	10	
	KT 4 3	39914	39915	4 × ø 3 mm	10	
	KT 4 4	39909	39911	4 × ø 4 mm	10	
	KT 4 5	39908	39910	4 × ø 5 mm	10	
	KT 4 6	39932	39933	4 × ø 6 mm	10	
	KT ASI	KT-ASI	39902	39903	1 ASI-cable	10
	KT-ASI2 rl	39922	39924	2 ASI-cables	10	
	KT-ASI2 lll	39921	39923	2 ASI-cables	10	
	KT oval	KT oval	39930	–	approx. 8 × 4 mm	10
	KT S1	KT S1	39931	–		10
	KT tele	KT tele	39929	–	Telephone cable	10
	KT tele1	41257	–	Data cable RJ12	10	
	KT tele2	41258	–	Data cable RJ10 / RJ45	10	



# KT-DPF

## Multi-range cable grommets, in pyramid shape, non-split

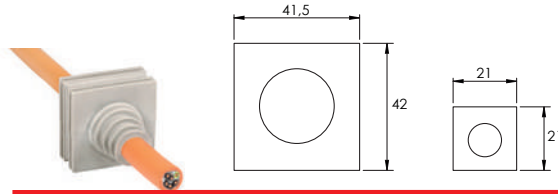

The multi-range KT-DPF grommets accept a wide range of cable diameters. A great benefit when the exact cable diameter is not known in advance. Due to the flexibility and unique pyramid shape, routing and flexible positioning of rigid cables is much easier compared to using conventional cable glands. It is recommended that additional strain relief be provided for the cables using a cable tie.

The KT-DPF small allows for the routing of cable diameters from 3 to 12 mm, the KT-DPF for diameters from 4 to 26 mm.

The KT-DPF grommets are not split and therefore only usable for cables without connectors.

Cutting of KT-DPF grommets: Cable diameter less 20%.

### Advantages

- Routing of cables without connectors through cable entry frames and split cable glands
- IP rating IP54
- High strain relief when a suitable cable entry is selected
- Large clamping range
- Only 3 grommets cover a clamping range from 3 to 26 mm
- Flexible even with rigid cables
- Ideal for wiring non pre-terminated cables locally
- Easy storage

### Specifications KT grey

Material	Elastomer
Flame class	UL 94 V-0, self-extinguishing
IP rating	IP54
UL type rating	UL type 12 (acc. to UL 50E)
Temperature	-40°C to +100°C (static)
Properties	Halogen-free, silicone-free

### Specifications KT black

Material	Elastomer
Flame class	UL94-HB
IP rating	IP54
Temperature	-30°C to +90°C (static)
Properties	Silicone-free Higher chemical resistance e.g. with aggressive oils, coolants

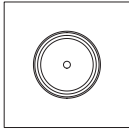
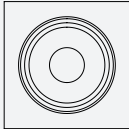
Description	Type	Order No ■ grey	Order No ■ black	Size KT	Clamping range	PU
	KT-DPF-A	41260	41360	KT small	3 – 12 mm	10
	KT-DPF-B	41261	41361	KT large	4 – 18 mm	10
	KT-DPF-C	41262	41362	KT large	14 – 26 mm	10



## KMS Cable template

Page 87

Order No. 39800



- 1
- 1.11
- 1.12
- 1.13
- 1.14
- 1.15
- 1.2
- 1.21
- 1.22
- 1.23
- 1.24
- 1.25
- 1.3

\*Only valid for grey product types

# KT-SC

## Multi-range cable grommets, non-split

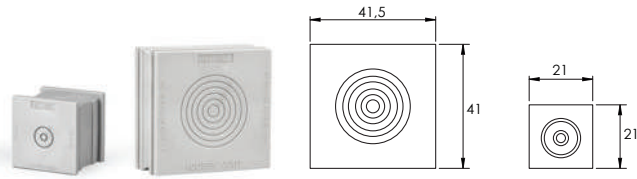

The KT-SC grommets accept a wide range of cable diameters. This is a great benefit when the exact cable diameter is not known in advance.

The single circular membrane can be peeled away to accommodate the specific diameter of the cable or hose. For this purpose, only a small hole between the rings needs to be pierced. Then the corresponding ring can be removed. The peeled-off area is always round, ensuring a secure seal around cable/hose.

The KT-SC cable grommet is based on the KT grommet and enables flexible routing and sealing (IP54) of electrical cables and pneumatic hoses with diameters from 4 to 28 mm.

The KT-SC cable grommets are not split and therefore only usable for cables without connectors. However, it is possible to feed through cables with a pre-mounted cable lug.

### Advantages

- Routing of cables without connectors through cable entry frames and split cable glands
- IP rating IP54
- Large clamping range
- Circular membranes can be peeled off easily
- Flexible even with rigid cables
- Ideal for wiring non pre-terminated cables locally
- Easy storage

### Specifications

Material	Elastomer
Flame class	UL 94 V-0, self-extinguishing
IP rating	IP54
UL type rating	UL type 12 (acc. to UL 50E)
Temperature	-40°C to +100°C (static)
Properties	Halogen-free, silicone-free

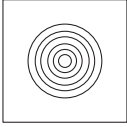
Description	Type	Order No.	Size KT	Clamping range	PU
	KT-SC small	41490	KT small	4 – 12 mm	10
	KT-SC large	41485	KT large	5 – 28 mm	10



## KMS Cable template

Page 87  
Order No. 39800



# KTMB

## Multi-range cable grommets, non-split

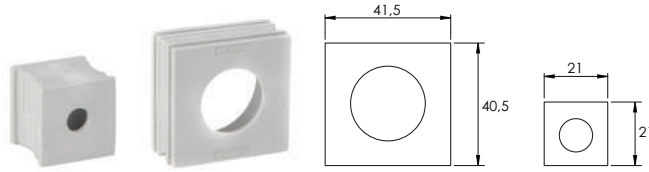

The KTMB grommets accept a wide range of cable diameters. A great benefit when the exact cable diameter is not known in advance.

The KTMB grommets are not split and therefore only usable for cables without connectors.

The model range KTMB small covers a diameter range from 2.5 to 16 mm, the model range KTMB large covers a diameter range from 13 to 33 mm.

### Advantages



- Routing of cables without connectors through cable entry frames and split cable glands
- IP rating IP54
- Ideal for wiring non pre-terminated cables locally
- Easy storage

### Specifications

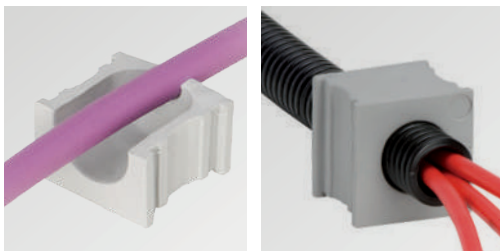
Material	Elastomer
Flame class	UL 94 V-0, self-extinguishing
IP rating	IP54
UL type rating	UL type 12 (acc. to UL 50E)
Temperature	-40°C to +100°C (static)
Properties	Halogen-free, silicone-free

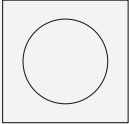

Cross section KTMB

Description	Type	Order No.	Size KT	Clamping range	PU
	KTMB-A	41432	KT small	2.5 – 6.5 mm	10
	KTMB-B	41434	KT small	4 – 7.5 mm	10
	KTMB-C	41436	KT small	6.5 – 10 mm	10
	KTMB-D	41438	KT small	9.5 – 13 mm	10
	KTMB-E	41440	KT small	13 – 16 mm	10
	KTMB-G	41460	KT large	13 – 18 mm	10
	KTMB-H	41465	KT large	18 – 23 mm	10
	KTMB-I	41470	KT large	23 – 28 mm	10
	KTMB-J	41475	KT large	28 – 33 mm	10
	KTMB-K	41480	KT large	2x 13 – 18 mm	10

1  
1.11  
1.12  
1.13  
1.14  
1.15  
1.2  
1.21  
1.22  
1.23  
1.24  
1.25  
1.3

# KT-DT

## Membrane cable grommets, non-split

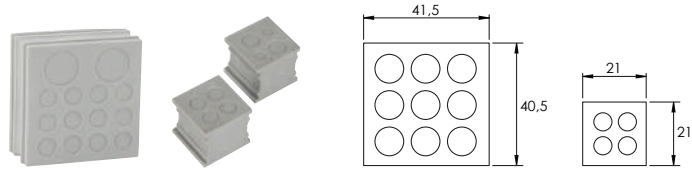

The KT-DT cable grommets can be used anywhere where a large number of electrical, pneumatic or hydraulic lines must be routed and sealed with IP54. By using the KT-DT grommets, the cable density can be significantly increased.

KT-DT grommets are compatible with split cable entry frames, such as KEL-U, KEL and KEL-FG. The routing of cables with and without preassembled connectors in one cable entry frame can thus be easily combined.

KT-DT 1 – KT-DT 5 grommets are designed to fit in KT large grommet spaces. KT-DT 7 and KT-DT 8 grommets are designed to fit in KT small grommet spaces.

The KT-DT grommets are also perfectly suitable for the assembly of subsequently terminated cable harnesses.

### Advantages

- Combination of routing pre-terminated cables and cables without connectors with one cable entry frame
- IP54 rating
- High cable density
- Enables sub-assembly of cable harnesses

### Specifications

Material	Elastomer
Flame class	UL 94 V-0, self-extinguishing
IP rating	IP54
UL type rating	UL type 12 (acc. to UL 50E)
Temperature	- 40°C to + 100°C (static)
Properties	Halogen-free, silicone-free

### Accessories

ST-B Plugs	171
------------	-----

Description	Type	Order No.	Number of cables	PU
	KT-DT 1	41500	12× max. 6.5 mm 2× max. 12.2 mm	10
	KT-DT 2	41510	16× max. 7.1 mm	10
	KT-DT 3	41520	4× max. 6.5 mm 3× max. 9.5 mm 3× max. 11.3 mm	10
	KT-DT 4	41530	9× max. 9.5 mm	10
	KT-DT 5	41540	4× max. 14.5 mm 1× max. 9.5 mm	10
	KT-DT 7	41550	4× max. 6 mm	10
	KT-DT 8	41552	2× max. 7 mm 2× max. 4 mm	10

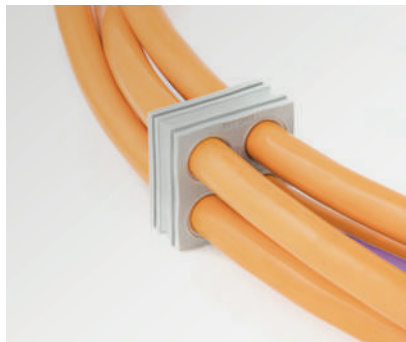

# ST

## Plugs for cable grommets



Plugs are used to close either KT or QT grommets which are not equipped with cables. IP ratings of the grommets remain.

Perfect for applications where cables have been removed or might be routed at a later stage.

### Advantages & benefits

- Sealing unused cable grommets

### Specifications

Material	Polyamide (PA), white
Flame class	UL 94 V-0, self-extinguishing
IP rating	IP rating of grommets remains
UL type rating	UL type 12 (acc. to UL 50E)
Temperature	-40°C to +120°C
Properties	Halogen-free, silicone-free

### Compatible with

KT Cable grommets	74 - 89
QT Cable grommets	118 - 119

Type	Order No.	Diameter D	Length L	PU
ST 1	42900	1 mm	25 mm	25
ST 2	42909	2 mm	25 mm	25
ST 3	42901	3 mm	25 mm	25
ST 4	42908	4 mm	25 mm	25
ST 5	42906	5 mm	25 mm	25
ST 6	42903	6 mm	25 mm	25
ST 7	42905	7 mm	25 mm	25
ST 8	42899	8 mm	20 mm	25
ST 9	42897	9 mm	20 mm	25
ST 10	42895	10 mm	20 mm	25
ST 11	42893	11 mm	20 mm	25
ST 12	42891	12 mm	20 mm	25
ST 13	42889	13 mm	20 mm	25
ST 14	42887	14 mm	20 mm	25
ST 15	42885	15 mm	20 mm	25
ST 16	42883	16 mm	20 mm	25
ST 17	42881	17 mm	20 mm	25
ST ASI	42877	–	25 mm	25

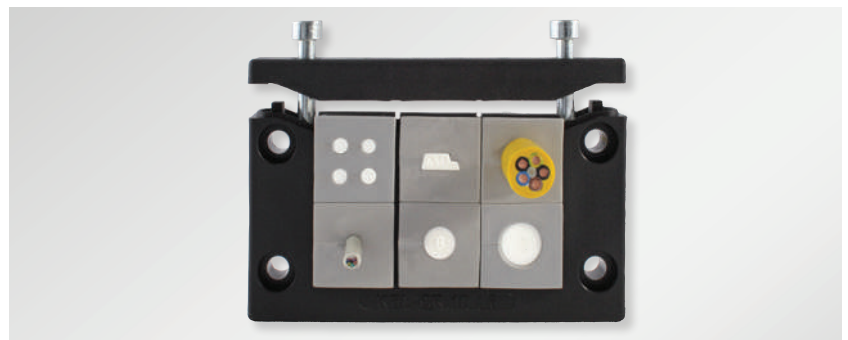
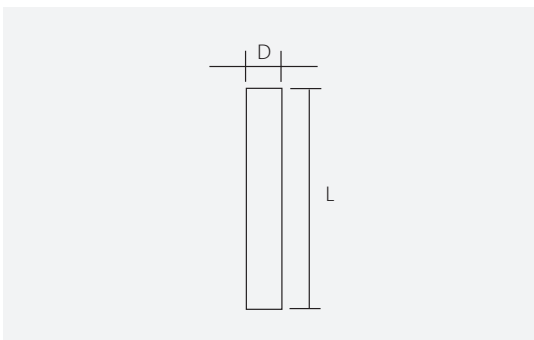

1  
1.11  
1.12  
1.13  
1.14  
1.15  
1.2  
1.21  
1.22  
1.23  
1.24  
1.25  
1.3

# Cover plugs for cable entry frames



The openings at the fastening points of the cable entry frames can be closed with the cover plugs.

There are two versions: One version to cover the openings when using threaded bushings, one to cover the screws. The cover plugs can be used with the products of the KEL series.

### Advantages

- Simple closing of the openings at the fastening points of the KEL
- Smooth finish on the frame surface
- No dirt recesses

### Specifications

Material	Polyethylene (PE)
Temperature	Continuous operating temperature +70°C
Properties	Higher chemical resistance

Description	Order No.	PU
Cover plugs <b>A</b> black for threaded bushings, for KEL	■ 99142	100
Cover plugs <b>B</b> black for M5 DIN 912 Screws, for KEL	■ 99200	40

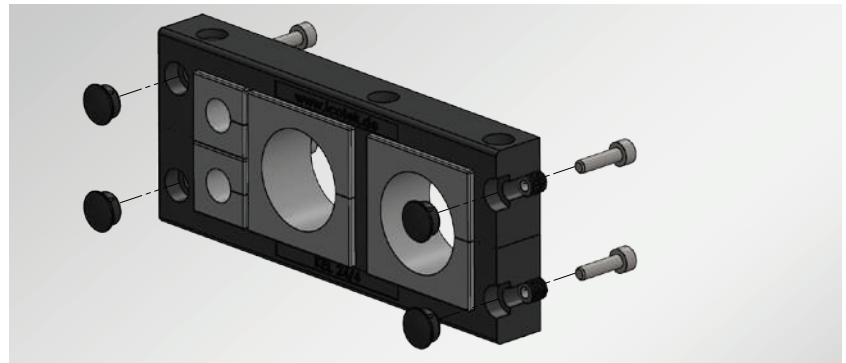

When fastening from the rear using a threaded bushing, an opening is created at the front at the fastening points. These can be closed with the **cover plugs A** in black (Order No. 99142).

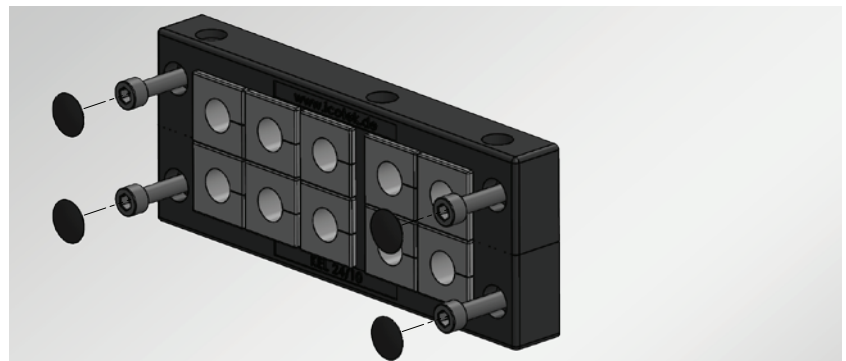

When fastening from the front by means of screws, the openings at the screw heads can be closed with the **cover plugs B** in black (order no. 99200). The cover plugs can only be used for M5 DIN 912 screws.



# KT ServiceBox

## Service box for cable grommets



### Convenient – everything available right away!

The KT ServiceBox is perfect for installations and service calls. It ensures your KT grommets are readily available.

### Content\*

#### Cable grommets, small:

- 110 KT for cables 1 – 17 mm
- 10 BTK blank grommets
  - 2 KTMB multi-range grommets
  - 8 KT-DPF multi-range grommets
- 1 KT-ASI for ASI-Bus cables
- AT-K-M 12x1.5

#### Cable grommets, large:

- 4 KT for cables 16 - 35 mm
- 3 BTG blank grommets / ATG adapter grommets
- 2 KTMB multi-range grommets
- 2 KT-DT multi-membrane grommets
- 2 KT-DPF multi-range grommets
- 2 KT-SC
- AT-M 12x1.0

#### Accessories:

- 1 Cable entry frame KEL-U 10|3
- 1 Cable entry frame KEL-E3
- 1 KVT split cable gland
- 1 KZL strain relief plate

- 1 Cable template

\* Subject to alterations



Description	Order No.	PU
KT ServiceBox	88001	1

## KMS

### Cable template

The correct size of the KT grommets can easily be determined by using the cable template.

- Determining the diameter of the cable using the cable template
- Selecting the KT grommets according to the data on the cable template

Cable templates can also be ordered separately.



Description	Order No.	PU
Cable template	39800	1

- 1
- 1.11
- 1.12
- 1.13
- 1.14
- 1.15
- 1.2
- 1.21
- 1.22
- 1.23
- 1.24
- 1.25
- 1.3



# Compile your own ServiceBox? Now it's easy with the grommet box configurator!

No more searching in vain for the right grommet: Now the assortment cases for different types and sizes of cable grommets of the KT or the QT series can be configured individually. So the perfect grommets are always at hand.

Start the configurator: [www.icotek.com/en/config/626044](http://www.icotek.com/en/config/626044)

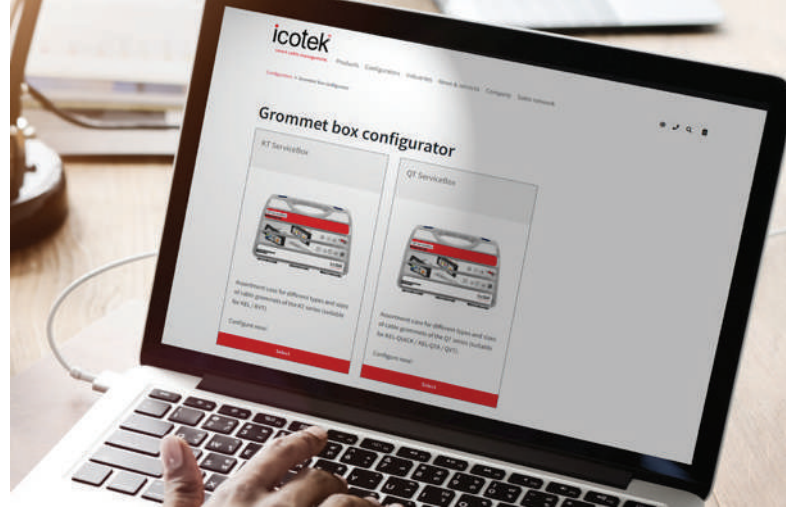

**1**

**2**

Pos.	Quantity	Size	Part No.	Type
1	1		80000	Box

**3**

Pos.	Quantity	Size	Part No.	Type
1	1		80000	Box
2	10	KT 2 gr	28934	KT 2 gr
3	10	KT 5.1 gr	28932	KT 5.1 gr
4	10	KT 6.2 gr	28937	KT 6.2 gr
5	5	AT-M-M 16.2 + bushhead fitting 04	28971	AT-M-M 16.2 + bushhead fitting 04
6	10	KT 2 gr	28934	KT 2 gr
7	10	KT 6.4 gr	28939	KT 6.4 gr
8	10	KT 2.4 gr	28936	KT 2.4 gr
9	10	AT-M-M 16.5 + 0.5	28955	AT-M-M 16.5 + 0.5
10	10	KT 1.5-2 r gr	28933	KT 1.5-2 r gr
11	5	AT-M-M 16.4 + bushhead fitting 04	28972	AT-M-M 16.4 + bushhead fitting 04
12	5	BTG 2.2 1P/5.6	41252	BTG 2.2 1P/5.6
13	10	AT-M-M 16.5 + 0.5	28953	AT-M-M 16.5 + 0.5

**4**

Pos.	Quantity	Size	Part No.	Type
1	1		80000	Box
2	10	KT 2 gr	28934	KT 2 gr
3	10	KT 5.1 gr	28932	KT 5.1 gr
4	10	KT 6.2 gr	28937	KT 6.2 gr
5	5	AT-M-M 16.2 + bushhead fitting 04	28971	AT-M-M 16.2 + bushhead fitting 04
6	10	KT 2 gr	28934	KT 2 gr
7	10	KT 6.4 gr	28939	KT 6.4 gr
8	10	KT 2.4 gr	28936	KT 2.4 gr
9	10	AT-M-M 16.5 + 0.5	28955	AT-M-M 16.5 + 0.5
10	10	KT 1.5-2 r gr	28933	KT 1.5-2 r gr
11	5	AT-M-M 16.4 + bushhead fitting 04	28972	AT-M-M 16.4 + bushhead fitting 04
12	5	BTG 2.2 1P/5.6	41252	BTG 2.2 1P/5.6
13	10	AT-M-M 16.5 + 0.5	28953	AT-M-M 16.5 + 0.5

**5**

Your request list: 176473703

Configuration

Item	Pos.	Part No.	Quantity	Type
	1	80000	1	Box
	2	28934	10	KT 2 gr
	3	28932	10	KT 5.1 gr
	4	28937	10	KT 6.2 gr
	5	28971	5	AT-M-M 16.2 + bushhead fitting 04
	6	28934	10	KT 2 gr
	7	28939	10	KT 6.4 gr
	8	28936	10	KT 2.4 gr
	9	28955	10	AT-M-M 16.5 + 0.5
	10	28933	10	KT 1.5-2 r gr
	11	28972	5	AT-M-M 16.4 + bushhead fitting 04
	12	41252	5	BTG 2.2 1P/5.6
	13	28953	10	AT-M-M 16.5 + 0.5





# The practical product configurator

With the product configurator, you can now assemble your cable entry system with the required cable or adapter grommets.

Check it out: [www.icotek.com/en/config](http://www.icotek.com/en/config)

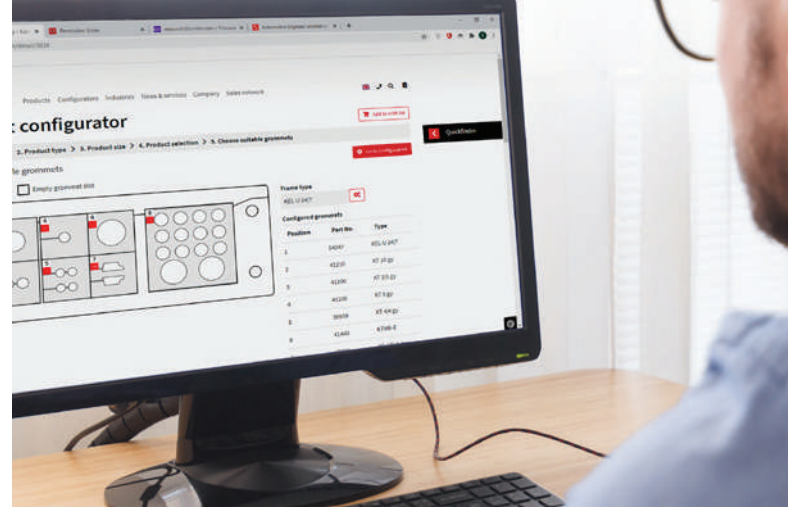

### Product configurator

1. Product group > 2. Product type > 3. Product size > 4. Product variant > 5. Choose suitable grommets

1. Choose product group

Cable entry frames for cables with connectors

Using the patented grommet based icotek KEL cable entry system, pre-terminated as well as standard cables without connectors can be routed into switch cabinets, control panels or machines. The cables are also sealed (up to IP68 / UL type 4x) and strain relieved.

Select

Cable glands for cables with connectors

By using split cable glands by icotek pre-terminated cables with diameters from 1 to 35 mm can be quickly routed into enclosures, control panels or machines and be sealed with up to IP68 / UL type 4x rated ingress protection (certified according to EN 60529 / UL50E). In addition, the cable glands serve as strain reliefs on the cables. The split cable glands enable quick and easy assembly which is great for retrofits and maintenance.

Select

EMC cable entry systems

In case of conducted as well as field bound EMI disturbances, our split EMC cable entry system offers an effective way to divert and block those disturbances and provides an economic alternative to expensive EMC cable glands.

Select

### Product configurator

1. Product group > 2. Product type > 3. Product size > 4. Product variant > 5. Choose suitable grommets

4. Choose product type

KEL-U 16|8

Mounting options: Snap-in with KEL-SNAP, Screw type mounting  
Classification: IP54, UL Type 12  
Max. cable diameter: 17 mm  
Length: 120 mm  
Width: 58 mm  
Height: 17 mm  
Max. cut-out width: 38 mm  
Max. cut-out length: 88 mm

Select

KEL-U 16|8 V2A

Mounting options: Snap-in with KEL-SNAP, Screw type mounting  
Classification: IP54, UL Type 12  
Max. cable diameter: 17 mm  
Length: 120 mm  
Width: 58 mm  
Height: 17 mm  
Max. cut-out width: 38 mm  
Max. cut-out length: 88 mm

Select

KEL-U 16|5

Mounting options: Snap-in with KEL-SNAP, Screw type mounting  
Classification: IP54, UL Type 12  
Max. cable diameter: 15 mm  
Length: 120 mm  
Width: 58 mm  
Height: 17 mm  
Max. cut-out width: 36 mm  
Max. cut-out length: 88 mm

Select

### Product configurator

1. Product group > 2. Product type > 3. Product size > 4. Product variant > 5. Choose suitable grommets

5. Choose suitable grommets

Part No.	Type	Size	Material
KT 7 gy	7-8 mm	KT small	Round cable
KT 8 gy	8-9 mm	KT small	Round cable
KT 9 gy	9-10 mm	KT small	Round cable
KT oval gy	-	KT small	Round cable
KT tela gy	-	KT small	Telephone cable

Select

### Product configurator

1. Product group > 2. Product type > 3. Product size > 4. Product variant > 5. Choose suitable grommets

5. Choose suitable grommets

Delete grommet:  Empty grommet slot

Frame type: KEL-U 16|5

Position	Part No.	Type
1	54165	KEL-U 16 5
2	41208	KT 8 gy
3	41210	KT 10 gy
4	41209	KT 9 gy
5	39956	AT-K-M M12 = 1.5

Select

### Product configurator

1. Product group > 2. Product type > 3. Product size > 4. Product variant > 5. Choose suitable grommets

5. Choose suitable grommets

Part No.	Type	Size	Material
AT-KS	IMAS-CONNECT Adaptertülle groß	-	-
AT-M 12 x 1.0	M12 x 1,0	IMAS-CONNECT Adaptertülle groß	-
AT-M 16 x 1.5	M16 x 1,5	IMAS-CONNECT Adaptertülle groß	-
AT-M 20 x 1.5	M20 x 1,5	IMAS-CONNECT Adaptertülle groß	-
AT-M 25 x 1.5	M25 x 1,5	IMAS-CONNECT Adaptertülle groß	-

Select

### Product configurator

1. Product group > 2. Product type > 3. Product size > 4. Product variant > 5. Choose suitable grommets

5. Choose suitable grommets

Delete grommet:  Empty grommet slot

Frame type: KEL-U 16|5

Position	Part No.	Type
1	54165	KEL-U 16 5
2	41208	KT 8 gy
3	41210	KT 10 gy
4	41209	KT 9 gy
5	39956	AT-K-M M12 = 1.5
6	39952	AT-KS

Select

1  
1.11  
1.12  
1.13  
1.14  
1.15  
1.2  
1.21  
1.22  
1.23  
1.24  
1.25  
1.3

## 1.15 Modular adapter system IMAS-CONNECT™ for the KT system



Simply configure the most individual cable entry in the world

**The IMAS-CONNECT™ adapter system is a modular designed grommet system for mounting metric connectors, PushPull modules, Keystone couplers, hose fittings, pressure compensation elements and much more.**

By utilising the modular adapter system, the cable entry frame becomes a hybrid system. Pre-terminated and standard cables or hoses can be routed. At the same time the system serves as a unique interface for all kinds of connectors. This means that only one interface or cut-out is required for various cables and connections.

The elastomer grommets with polyamide body fit perfectly into the icotek cable entry frames e.g. KEL-U, KEL-ER, KEL-FG and comply with protection classes IP54 to IP66.

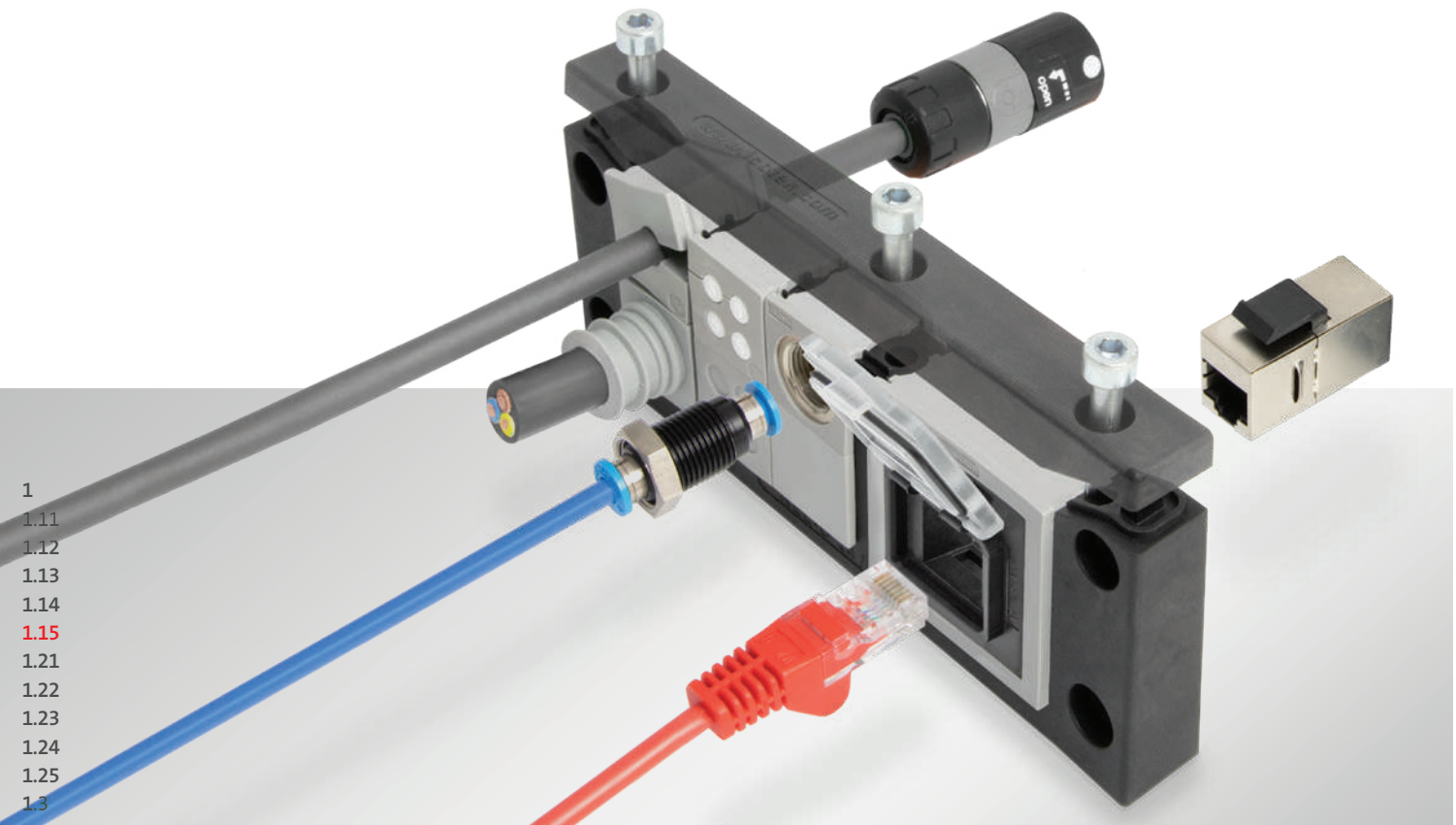

- 1
- 1.11
- 1.12
- 1.13
- 1.14
- 1.15
- 1.21
- 1.22
- 1.23
- 1.24
- 1.25
- 1.3



Adapter grommet, small with threaded insert

AT-K-M | AT-K-Z

92

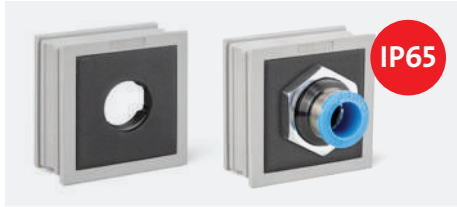

Adapter grommet, large with metric inner thread

AT-M

93



Adapter grommet, blank, large

AT-B

93



Adapter grommet, large for M23 square flange

AT-FL

94



Adapter grommet, large for PushPull connector systems

AT-PP

95



Adapter grommet, large for Keystone couplers

AT-KS

96



Adapter grommet, large for Keystone couplers, with protection cover

AT-KS-AK

97



Adapter grommet, large with mounted Keystone modules or bulkhead couplings, product set

98

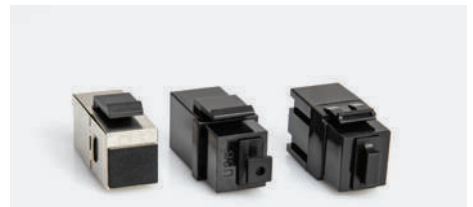

Keystone modules, single, bulkhead couplings and accessories

99



Pressure compensation element with metric thread

PCE

100

- 1
- 1.11
- 1.12
- 1.13
- 1.14
- 1.15
- 1.21
- 1.22
- 1.23
- 1.24
- 1.25
- 1.3

## AT-K-M | AT-K-Z

### Adapter grommet, small with threaded insert



The AT-K-M grommet is constructed on the basis of a KT cable grommet. The grommets are made of elastomer with a nickel-plated brass body. The AT-K-M grommets are available with inner threads in sizes M5 x 0.5, M8 x 0.5, M8 x 1.0, M12 x 1.0, M12 x 1.5, M14 x 1.0 and M16 x 1.5 and the AT-K-Z grommets with inner threads in sizes 1/8" and 1/4".

By using the AT-K-M adapter grommet, several connectors can be inserted directly into the cable entry frame, e.g. pneumatic bulkhead connectors M12 x 1.0 and M14 x 1.0, metric connectors and pressure compensation elements.

They are compatible with all split icotek cable entry systems that are suitable for KT cable grommets.

#### Advantages & benefits

- By using AT-K-M grommets, panel connectors and sockets can be integrated directly into the cable entry system
- Separate cut-outs for connectors are no longer necessary
- Space-saving solution
- Thread sizes M5 to M16 and 1/8" to 1/4" available

#### Specifications

Material	Grommet: Elastomer Body: nickel-plated brass
Flame class	UL 94 V-0, self-extinguishing
Protection class	IP66 when using correct components
Temperature	-40°C bis +100°C (static)
Properties	Halogen free, silicone free

Type	Order No.	Height × Width × Length [mm]	Thread	Material	PU
AT-K-M 5x0.5	39953	21 x 21 x 19	M5 x 0.5	Brass/Elastomer	5
AT-K-M 8x0.5	39966	21 x 21 x 19	M8 x 0.5	Brass/Elastomer	5
AT-K-M 8x1.0	39954	21 x 21 x 19	M8 x 1.0	Brass/Elastomer	5
AT-K-M 12x1.0	39955	21 x 21 x 19	M12 x 1.0	Brass/Elastomer	5
AT-K-M 12x1.5	39956	21 x 21 x 19	M12 x 1.5	Brass/Elastomer	5
AT-K-M 14x1.0	39962	21 x 21 x 19	M14 x 1.0	Brass/Elastomer	5
AT-K-M 16x1.5	39957	21 x 21 x 19	M16 x 1.5	Brass/Elastomer	5
AT-K-Z 1/8"	39963	21 x 21 x 19	1/8"	Brass/Elastomer	5
AT-K-Z 1/4"	39964	21 x 21 x 19	1/4"	Brass/Elastomer	5



AT-K-M with extension M16x1,5 for M12 built-in connectors

## AT-M | AT-B

### Adapter grommet, large with metric inner thread



AT-M is a grommet (based on large KT grommets) with integrated metric threads, suitable for split icotek cable entry systems. The AT-M grommets are made of elastomer with a polyamide body. AT-M grommets are available with inner threads in sizes M12x1.0, M16x1.5, M20x1.5 and M25x1.5.

The AT-M is ideal for creating an interface for signal, data, power and hybrid connectors by simply screwing them into the AT-M thread. Pressure compensation elements or conduit connectors up to M25x1.5 can also be screwed into the AT-M.

icotek also offers screw plugs for sizes M16, M20 and M25 to close the new adapter grommet with the metric internal thread AT-M.

There is also a blank AT-B grommet available. The integrated polyamide body is completely closed on one side. The effective area is 24 x 24 mm, the wall thickness is 6 mm. Custom drill-holes and cut-outs can be made here for e.g. installation of screw mounted hybrid connectors.

#### Advantages & benefits

- By using AT-M grommets, panel connectors and sockets can be integrated directly into the cable entry system
- Separate cut-outs for connectors are no longer necessary
- Space-saving solution
- Thread sizes M12 to M25 available
- Blank grommet for flexible use

#### Specifications

Material	Grommet: Elastomer Body with thread: Polyamide
Flame class	UL94-V0, self-extinguishing
Protection class	IP65 when using correct components
Temperature	-40°C to +100°C (static)
Properties	Halogen free, silicone free



Type	Order No.	Height x width x length [mm]	Thread	Material	PU
AT-M 12x1.0	39946	42 x 41.5 x 19	M12 x 1.0	PA/Elastomer	10
AT-M 16x1.5	39947	42 x 41.5 x 19	M16 x 1.5	PA/Elastomer	10
AT-M 20x1.5	39948	42 x 41.5 x 19	M20 x 1.5	PA/Elastomer	10
AT-M 25x1.5	39949	42 x 41.5 x 19	M25 x 1.5	PA/Elastomer	10
AT-B blank	39950	42 x 41.5 x 19	–	PA/Elastomer	10

#### Screw plugs for AT-M

Type	Order No.	Thread	Material	PU
Screw plug M16 x 1.5	99195	M16	Polyamide	10
Screw plug M20 x 1.5	99196	M20	Polyamide	10
Screw plug M25 x 1.5	99197	M25	Polyamide	10



KEL-U 24/7 mounted with 1x AT-M, equipped with 1 connector M12x1.0, for the connection of sensors

1  
1.11  
1.12  
1.13  
1.14  
1.15  
1.21  
1.22  
1.23  
1.24  
1.25  
1.3

# AT-FL

## Adapter grommet, large for M23 square flange



The grommet AT-FL is constructed on the basis of a large KT cable grommet. The polyamide body is moulded with elastomer. All square flanges with dimensions 19.8 x 19.8 mm (M23) can be integrated.

The insertion of AT-FL into an icotek cable entry frame enables the routing of cables with and without connectors in combination with the creation of interfaces for M23 connectors within one cable entry system. Separate cut-outs for connectors are no longer necessary.

AT-FL provides ingress protection of up to IP65 (depending on the used flange and connector).

### Advantages & benefits

- By using the AT-FL grommet, connectors can be integrated directly into the cable entry frame
- Separate cut-outs for connectors are no longer necessary
- Space-saving solution
- Cost-saving assembly

### Specifications

Material	Grommet: Elastomer Body: Polyamide
Flame class	UL 94 V-0, self-extinguishing
Protection class	IP54, IP55, IP64, IP65
Temperature	-40°C to +100°C (static)
Properties	Halogen free, silicone free

Type	Order No.	Height x width x length [mm]	Material	PU
AT-FL	39965	42 x 41.5 x 19	PA/Elastomer	5

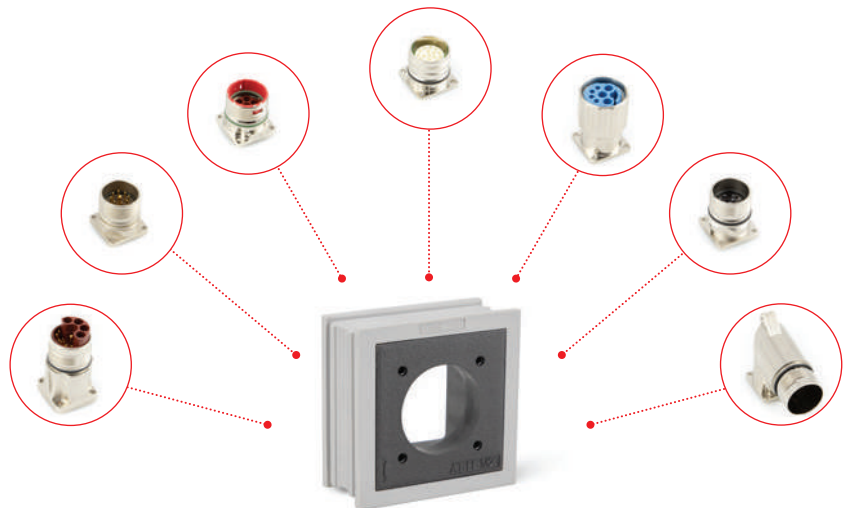

# AT-PP

## Adapter grommet, large for PushPull connector systems



The grommet AT-PP is constructed on the basis of a large KT cable grommet. In this elastomer grommet, a polyamide body is integrated. All modules based on the PushPull system can be inserted into the grommet.

By using the grommet AT-PP, the split cable entry frame can be used to route pre-terminated cables and at the same time it can also be used as an interface for connectors. This can save additional cut-outs and reduce labour costs.

PushPull modules and add-on housings are not included in the scope of delivery.

### Advantages & benefits

- By using AT-PP grommets, panel connectors and sockets can be integrated directly into the cable entry system
- Separate cut-outs for connectors are no longer necessary
- Time saving solution
- Space-saving solution
- Assembly costs are reduced

### Specifications

Material	Grommet: Elastomer Body with thread: Polyamide
Flame class	UL 94 V-0, self-extinguishing
Protection class	IP65 when using correct components
Temperature	-40°C to +100°C (static)
Properties	Halogen free, silicone free

Type	Order No.	Height x width x length [mm]	Material	PU
AT-PP	39961	42 x 41.5 x 19	PA/Elastomer	5



The module (left) snaps into the rear of the add-on housing mounted on the AT-PP



- 1
- 1.11
- 1.12
- 1.13
- 1.14
- 1.15
- 1.21
- 1.22
- 1.23
- 1.24
- 1.25
- 1.3

# AT-KS

## Adapter grommet, large for Keystone couplers



The grommet AT-KS is constructed on the basis of a KT cable grommet. In this elastomer grommet, a polyamide body is integrated. All couplers based on the Keystone system can be simply snapped in.

By using the grommet AT-KS, the split cable entry frame can be used to route pre-terminated cables and at the same time it can also be used as an interface for connectors. This can save additional cut-outs and reduce labour costs.

### Advantages & benefits

- By utilising the AT-KS grommet, connectors can be integrated directly into the cable entry frame
- Separate cut-outs for connectors are no longer necessary
- Space-saving solution
- Grommet is suitable for all Keystone couplers
- Snap-in assembly

### Specifications

Material	Grommet: Elastomer Body: Polyamide
Flame class	UL 94 V-0, self-extinguishing
Protection class	IP54 depending on Keystone module and manufacturer
Temperature Properties	-40°C to +100°C (static) Halogen free, silicone free

Individual Keystone modules on page 99.

Type	Order No.	Height x Width x Length [mm]	Material	PU
AT-KS	39952	42 x 41.5 x 19	PA/Elastomer	10

### Adapter grommet with pre-assembled keystone modules

Type	Order No.	Height x Width x Length [mm]	Colour Keystone module	PU
AT-KS-USB 3.0	39968	42 x 41.5 x 19	black	1
AT-KS-USB-C	39981 <span style="background-color: red; color: white; padding: 2px;">NEW</span>	42 x 41.5 x 19	black	1
AT-KS-HDMI	39969	42 x 41.5 x 19	black	1
AT-KS-CAT6	39970	42 x 41.5 x 19	silver	1
AT-KS-CAT7	39983 <span style="background-color: red; color: white; padding: 2px;">NEW</span>	42 x 41.5 x 19	silver	1

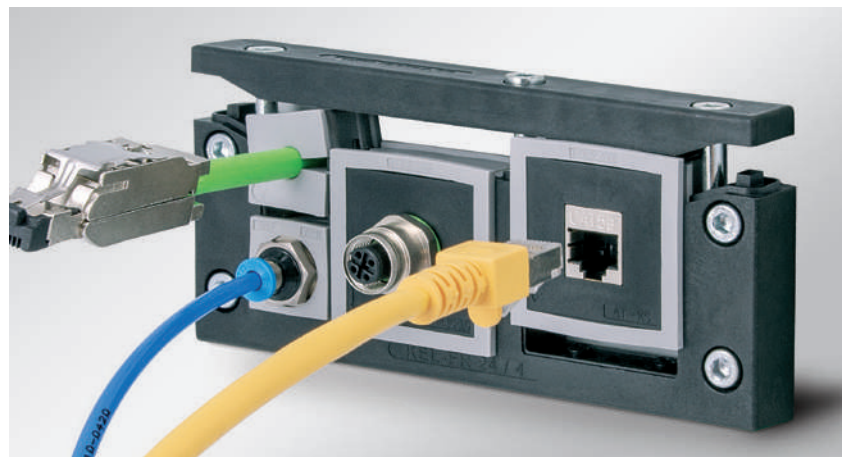
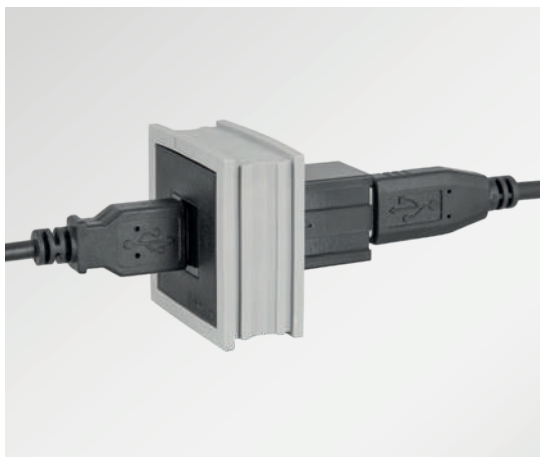

USB-, RJ45 or e.g. HDMI connectors can be plugged in from the front and from the back



# AT-KS-AK

## Adapter grommet, large for Keystone couplers with protection cover



The polyamide body integrated into the adapter grommet enables all modules based on the Keystone system to be snapped in. The interface can be closed and even sealed using a protective cover on the front.

By using the grommet AT-KS-AK, the split cable entry frame can be used to route pre-terminated cables and at the same time it can also be used as an interface for connectors. This can save additional cut-outs and reduce labour costs.

AT-KS-AK fulfils protection classes up to IP54 when the cover is closed (regardless of the Keystone module type and manufacturer).

### Advantages

- By utilising the AT-KS-AK grommet, connectors can be integrated directly into the cable entry frame
- Separate cut-outs for connectors are no longer necessary
- Space-saving solution
- Easy to install thanks to lockable cover flap
- Cover flap can be secured by sealing

### Specifications

Material	Grommet: Elastomer Body: Polyamide Cover flap: Polycarbonate
Flame class	UL 94 V-0, self-extinguishing
Protection class	IP54 (certified according to EN 60529)
Temperature	-40°C to +100°C (static)
Properties	Halogen free, silicone free

Type	Order No.	Height × Width × Length [mm]	Material	PU
AT-KS-AK	39967	42 × 41.5 × 19	PA/Elastomer/PC	10

### Adapter grommet with mounted Keystone modules and protection cover

Type	Order No.	Height × Width × Length [mm]	Colour Keystone module	PU
AT-KS-AK-USB 3.0	39977	42 × 41.5 × 19	black	1
AT-KS-AK-HDMI	39978	42 × 41.5 × 19	black	1
AT-KS-AK-CAT6	39979	42 × 41.5 × 19	silver	1
AT-KS-AK-CAT7	39982	42 × 41.5 × 19	silver	1
AT-KS-AK-USB-C	39980	42 × 41.5 × 19	black	1

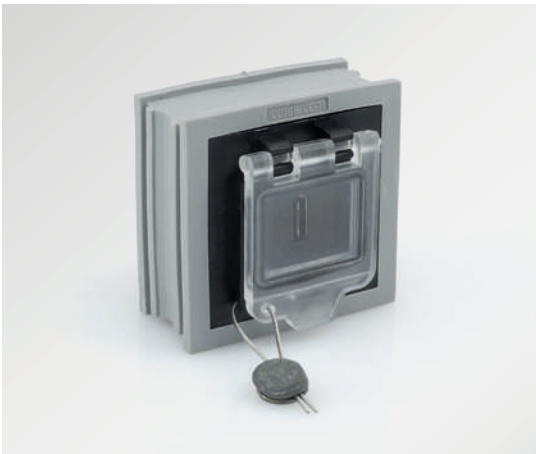

Cover flap can be secured by sealing

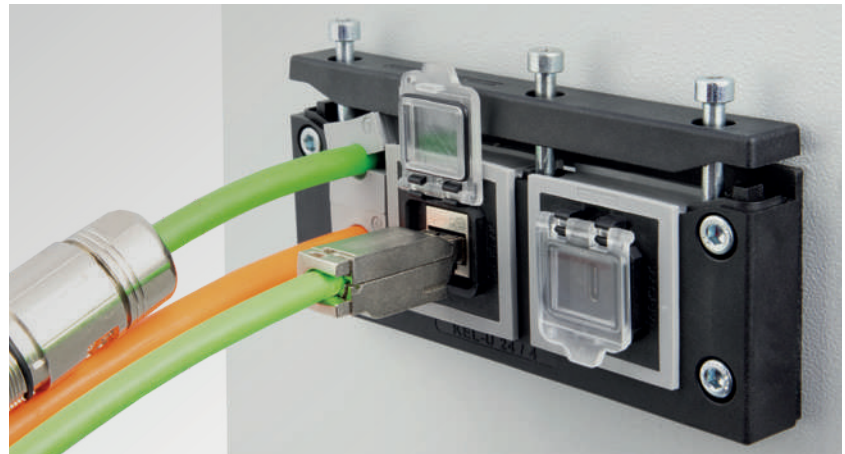

- 1
- 1.11
- 1.12
- 1.13
- 1.14
- 1.15
- 1.21
- 1.22
- 1.23
- 1.24
- 1.25
- 1.3

# Adapter grommet

with mounted Keystone modules  
or bulkhead couplings,  
product set



The adapter grommets type AT-KS are also supplied with pre-assembled keystone modules, type AT-K-M with bulkhead couplings/fittings.

## Advantages & benefits

- By utilising the AT-KS grommet, connectors can be integrated directly into the cable entry frame
- Separate cut-outs for connectors are no longer necessary
- Space-saving solution
- Keystone modules or bulkhead couplings/fittings are already pre-assembled

## Specifications

Material	Grommet: Elastomer Body: Polyamide Bulkhead coupling: Brass nickel plated
Flame class	UL 94 V-0, self-extinguishing
Protection class	IP54 depending on Keystone module and manufacturer
Temperature Properties	-40°C to +100°C (static) Halogen free, silicone free

Type	Order No.	Height × Width × Length [mm]	Colour Keystone module	PU
AT-KS-USB 3.0	39968	42 x 41.5 x 19	black	1
AT-KS-USB-C	39981 <b>NEW</b>	42 x 41.5 x 19	black	1
AT-KS-HDMI	39969	42 x 41.5 x 19	black	1
AT-KS-CAT6	39970	42 x 41.5 x 19	silver	1
AT-KS-CAT7	39983 <b>NEW</b>	42 x 41.5 x 19	silver	1

Type	Order No.	Height × Width × Length [mm]	suitable for pneumatic hose	PU
AT-K-M 12x1,0 with bulkhead coupling	39971	21 x 21 x 19	4 mm	1
AT-K-M 14x1,0 with bulkhead coupling	39972	21 x 21 x 19	6 mm	1
AT-K-Z 1/4" with 2x bulkhead fitting	39973 <b>NEW</b>	21 x 21 x 19	8 mm	1
AT-K-Z 1/4" with 2x bulkhead fitting	39974 <b>NEW</b>	21 x 21 x 19	10 mm	1
AT-K-Z 1/4" with 2x bulkhead fitting	39975 <b>NEW</b>	21 x 21 x 19	12 mm	1



# Keystone modules, bulkhead couplings and accessories



The Keystone modules and bulkhead couplings are also available individually for use with the adapter grommets.

## Advantages & benefits

- By utilising the adapter grommets, connectors can be integrated directly into the cable entry frame
- Separate cut-outs for connectors are no longer necessary
- Space-saving solution
- Snap-in assembly

## Specifications

Material	Bulkhead coupling: Brass nickel plated
Flame class	UL 94 V-0, self-extinguishing
Protection class	IP54 depending on module type and manufacturer
Temperature	-40°C to +100°C (static)
Properties	Halogen free, silicone free

## Keystone modules

Type	Order No.	Colour	PU
Keystone module USB 3.0	99204	black	5
Keystone module USB-C	99212 <b>NEW</b>	black	5
Keystone module HDMI	99205	black	5
Keystone module CAT 6	99206	silver	5
Keystone module CAT 7	99213 <b>NEW</b>	silver	5

## Bulkhead couplings

Type	Order No.	suitable for pneumatic hose	Thread	PU
Bulkhead coupling D4	99210	4 mm	M12 x 1.0	10
Bulkhead coupling D6	99211	6 mm	M14 x 1.0	10
Bulkhead fitting D8	99227 <b>NEW</b>	8 mm	1/4"	10
Bulkhead fitting D10	99228 <b>NEW</b>	10 mm	1/4"	10
Bulkhead fitting D12	99229 <b>NEW</b>	12 mm	1/4"	10

## Dust caps

Type	Order No.	suitable for	PU
Dust caps for HDMI	99207	HDMI connectors	5
Dust caps for USB	99208	USB connectors	5
Dust caps for RJ-45	99209	RJ-45 connectors	5



1  
 1.11  
 1.12  
 1.13  
 1.14  
 1.15  
 1.21  
 1.22  
 1.23  
 1.24  
 1.25  
 1.3

## PCE M12 x 1.5

### Pressure compensation element with metric thread



The pressure compensation element PCE with M12 x 1.5 thread is used to avoid variations in pressure caused by differences in temperature and thus to prevent damage caused by condensation. It provides protection class IP68. The pressure compensation element is easy to install by screwing it directly into the enclosure wall or via adapter grommets AT-K-M 12x1.5.

Type	Order No.	Thread	PU
PCE M12 x 1.5	99190	M12 x 1.5	10

#### Specifications

Material	Polyamide
Flame class	UL 94 V-2
Protection class	IP67, IP68
Temperature	-20°C to +100°C



KVT-ER 63/4 equipped with pressure compensation element

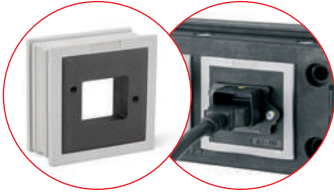

Available with pre-terminated cut-out for PushPull systems (AT-PP)

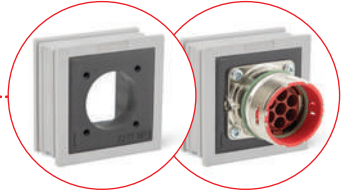

New: Adapter grommet for M23 square flange (AT-FL)

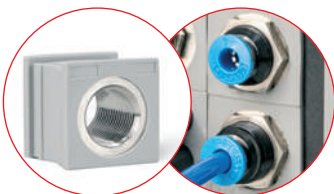

Available with threaded insert (AT-K-M/AT-K-Z), based on the KT cable grommet

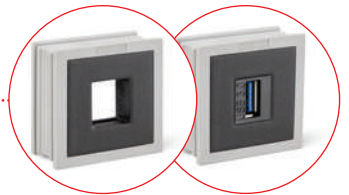

Available with pre-terminated cut-out for Keystone couplers (AT-KS)



Perfect integration into the split icotek cable entry frames

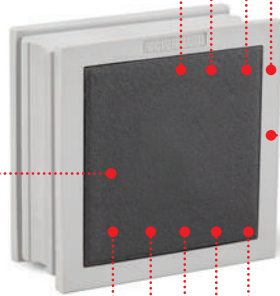

Available with metric inner threads of M12 x 1.0, M16 x 1.5, M20 x 1.5, M25 x 1.5 (AT-M).

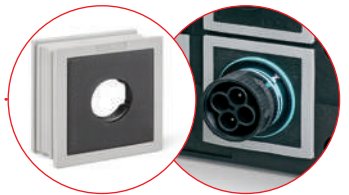

At a high cable density only one cut-out is necessary

Usable area for special cut-outs and drill-holes: 24 x 24 mm; Wall thickness: 6 mm (AT-B)

Elastomer grommet with polyamide body based on the grommet KT large

High protection class: up to IP66

Available with protection cover for Keystone modules (AT-KS-AK)



- 1
- 1.11
- 1.12
- 1.13
- 1.14
- 1.15
- 1.21
- 1.22
- 1.23
- 1.24
- 1.25
- 1.3

## 1.2 Cable entry systems for the QT grommet system



The QUICK systems are the perfect solution for the routing of cables with and without connectors when cost-effectiveness is the priority.

Here, too, the concept of consistent divisibility is applied. This system places great emphasis on tool-free assembly, for example in combination with the KEL-SNAP frame.

With the split QT grommets, cable diameters from 1 to 29 mm can be covered. With correct assembly, a protection class of IP54 is achieved.

The QTMB grommets allow the routing of cables with diameters that can vary up to 3 mm. By using the QT-DT grommet, the packing density of the cables can be considerably increased and the required installation space considerably reduced.

www.icotek.com

KEL-QUICK

QVT-CLICK

Fast and easy assembly

Split system

Fast and easy assembly

High cable density, wide variety in cable grommets and adapter grommets

Snap-in and screw-in assembly possible for QVT-CLICK sizes 16, 20, 40|1, 50|1, 50|4

- 1
- 1.11
- 1.12
- 1.13
- 1.14
- 1.15
- 1.2
- 1.21
- 1.22
- 1.23
- 1.24
- 1.25
- 1.3



IP54

Split cable entry frames  
for quick assembly,  
for standard cut-outs,  
for cable diameters up to 29 mm

KEL-QUICK

104 – 107



IP54

Split cable glands  
for screw-in assembly,  
for standard cut-outs,  
for cable diameters up to 15 mm

QVT

108 – 110



IP54

Split cable glands  
for screw-in or snap-in assembly,  
for standard cut-outs,  
for cable diameters up to 29 mm

QVT-CLICK

109 – 111



IP54

Split cable entry plates  
for push-in assembly,  
for standard cut-outs,  
for cable diameters up to 15 mm

KEL-QTA / KEL-QTE

113 – 115

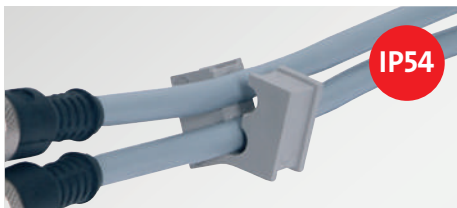

IP54

Cable grommets  
for the QT system,  
split and not split,  
for cables with/without connectors,  
for cable diameters 1 – 29 mm

118 – 121



QT Servicebox  
Service box for cable grommets

121



IP54

IMAS-CONNECT™  
Modular adapter system  
for the QT system

124 – 132



IP54

Snap mounting frames  
for installation of KEL-U/KEL frames,  
split (KEL-SNAP-S)

KEL-SNAP-S / KEL-SNAP

52 – 55



Thread extension  
for cable glands and cable entry plates  
M32, M50, M63

TE-M

334 – 337

- 1
- 1.11
- 1.12
- 1.13
- 1.14
- 1.15
- 1.2
- 1.21
- 1.22
- 1.23
- 1.24
- 1.25
- 1.3

## 1.21 Split cable entry frames for the QT grommet system



The QUICK systems are the perfect solution for the routing of cables with and without connectors when cost-effectiveness is the priority.

Here, too, the concept of consistent divisibility is applied. This system places great emphasis on tool-free assembly, for example in combination with the KEL-SNAP frame.

Cut-outs according to industrial standard dimensions

Warranty on pre-terminated cables remains

High cable density, wide variety

Fast and easy assembly

Split system

Can be combined with IMAS-CONNECT grommets

KEL-QUICK

www.icotek.com

- 1
- 1.11
- 1.12
- 1.13
- 1.14
- 1.15
- 1.2
- 1.21
- 1.22
- 1.23
- 1.24
- 1.25
- 1.3



# KEL-QUICK series

## Cable entry frames for quick assembly with IP54 rating

IP54

The KEL-QUICK range is a compact system to route and seal pre-terminated cables as well as conduits or pneumatic hoses utilising split QT and QTMB grommets. After populating the entry frame with QT/QTMB grommets and cables, the cover lid is snapped onto the frame without using assembly hardware.

The KEL-QUICK frames match exactly the cut-out dimensions for 10-, 16- and 24-pin standard industrial connectors. The KEL-QUICK-B frames match the cut-out dimensions 46 × 36 mm. These KEL-QUICK frames can either be screw mounted or simply snapped into the KEL-SNAP frame.

The single-row KEL-QUICK-E versions are particularly suited for flat connectors. The small frames are ideal for applications with limited space.

A flat rubber gasket is included in the shipment.

### Advantages & benefits

- Fast and easy assembly and when used with the KEL-SNAP frame, mounting without tools possible
- Maintain manufacturer's warranty on pre-terminated cables
- Retrofittings, repairs and maintenance can be done much more easily and quickly
- High cable density, wide variety of grommets
- Can be combined with IMAS-CONNECT grommets

### Specifications

Material	Polyamide (PA)
Flame class	UL 94 V-0, self-extinguishing
IP rating	IP54, with gasket and correct selection of the cable grommets
Temperature	-40°C to +140°C (static)
Properties	Halogen-free, silicone-free
Frame depth	17 mm

### Accessories

QT Cable grommets	128 - 121
KEL-SNAP Mounting frames	52 - 55
KEL-EMC Cable collectors	260 - 262
KDR Base plates	300 - 311
FP Flange plates	320 - 329
MP Module plates	314 - 315
ST Plugs	85



Cover lid is simply snapped onto the frame



Tool-free mounting with KEL-SNAP frame



KEL-QUICK-E

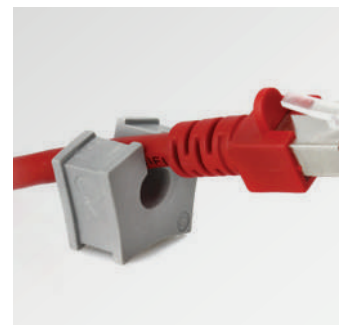

Split grommets



- 1
- 1.11
- 1.12
- 1.13
- 1.14
- 1.15
- 1.2
- 1.21
- 1.22
- 1.23
- 1.24
- 1.25
- 1.3

**i** Single-piece packaging units are available on request.

# KEL-QUICK

Cable entry frames  
for quick assembly

KEL-QUICK 24, KEL-QUICK 16,  
KEL-QUICK 10



Description	Cut-out   Drilling template	Type	Order No.	Cut-out [mm]	Grommets	PU
		KEL-QUICK 24 10	42410	112 × 36	10 –	10
		KEL-QUICK 24 7	42412	112 × 36	6 1	10
		KEL-QUICK 24 4	42413	112 × 36	2 2	10
		KEL-QUICK 16 8	42418	86 × 36	8 –	10
		KEL-QUICK 16 5	42425	86 × 36	4 1	10
		KEL-QUICK 16 2	42426	86 × 36	0 2	10
		KEL-QUICK 10 6	42420	65 × 36	6 –	10
		KEL-QUICK 10 3	42427	65 × 36	2 1	10

# KEL-QUICK

## Cable entry frames for quick assembly

### KEL-QUICK-E



Description	Cut-out   Drilling template	Type	Order No.	Cut-out [mm]	Grommets	PU
		KEL-QUICK-B4	42434	46 × 46	4 -	10
		KEL-QUICK-B1	42435	46 × 46	- 1	10
		KEL-QUICK-E5	42424	24 × 112	5 QT	10
		KEL-QUICK-E4	42423	24 × 86	4 QT	10
		KEL-QUICK-E3	42422	24 × 65	3 QT	10
		KEL-QUICK-E2	42421	24 × 43	2 QT	10

**i** Single-piece packaging units are available on request.

- 1
- 1.11
- 1.12
- 1.13
- 1.14
- 1.15
- 1.2
- 1.21**
- 1.22
- 1.23
- 1.24
- 1.25
- 1.3

## 1.22 Split cable glands for the QT grommet system

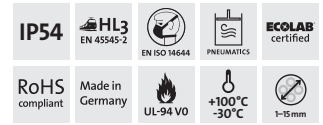

By using split QVT cable glands by icotek cables with or without connectors or complete cable harnesses with diameters from 1 to 15 mm can be quickly routed into enclosures, cabinets or machines and be sealed with IP54 rated ingress protection.

The split system of the QVT cable glands enables quick and easy assembly which is great for retrofitting and maintenance. The cable is placed into the split grommet which is set into one of the gland halves. Depending on the size of the cable gland one, two or four separate grommets can be installed. The two gland halves can be easily snapped together without the need of tools. The routed lines are securely sealed and held inside the grommets. To mount the cable glands either snap it into the round metric standard cut-out (sizes available from M16 to M50) or screw it with a hexagonal locknut. The mounting method is dependent on the model type.

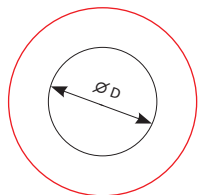

For metric cut-outs  
M16 – M50



Warranty on pre-terminated  
cables remains

Split system

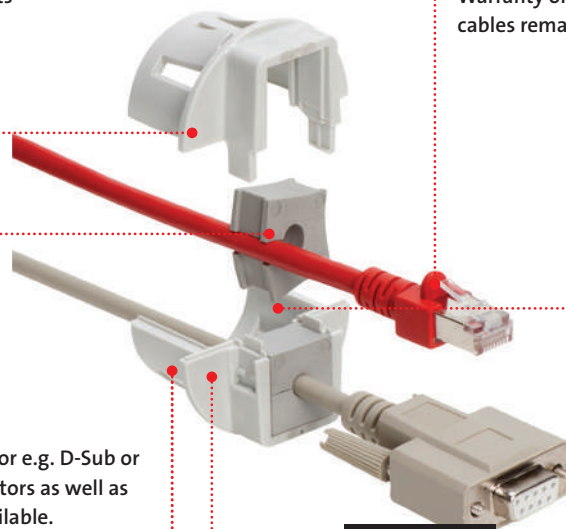

High cable density,  
wide variety in cable  
grommets

Special locknuts for e.g. D-Sub or  
PROFIBUS connectors as well as  
split locknuts available.



QVT-CLICK

Fast and easy assembly

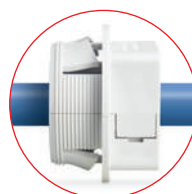

Snap-in and screw-in assembly  
possible for QVT-CLICK sizes  
16, 20, 40|1, 50|1, 50|4

1  
1.11  
1.12  
1.13  
1.14  
1.15  
1.2  
1.21  
1.22  
1.23  
1.24  
1.25  
1.3

# QVT | QVT-CLICK

## Split cable glands for snap-in or screw-in assembly with IP54 rating

IP54

QVT and QVT-CLICK are circular split frames for quick and easy installation of pre-terminated cables or complete cable harnesses. But also electric, pneumatic or hydraulic lines without terminals or connectors as well as corrugated conduits can be easily routed and sealed with IP54. Because of its extremely compact design, the QVT/QVT-CLICK range is especially suitable for small machines, devices and instruments.

The cable glands are easy to install. The prefabricated cable is placed into the split grommet which is set into one of the gland halves. Depending on the size of the cable gland, one, two or four separate grommets can be installed. By using multi-hole grommets up to 16 lines can be routed with one cable gland.

The QVT-CLICK can be assembled without tools from the front of the enclosure wall. Sizes QVT-CLICK 16, QVT-CLICK 20, QVT-CLICK 40|1, QVT-CLICK 50|1 and QVT-CLICK 50|4 can also be screwed on with a lock nut.

QVT: Polyamide lock nuts as well as a sealing ring are included in the shipment. QVT-CLICK: A sealing ring is included in the shipment.

### Advantages & benefits

- Compact design
- Routing of pre-terminated cables
- Maintain manufacturer's warranty on pre-terminated cables
- Retrofittings, repairs and maintenance can be done much more easily and quickly
- Suitable for metric cut-outs
- Lock nut is included
- Can be combined with IMAS-CONNECT system

### Advantages & benefits QVT-CLICK

- Fast and easy mounting from the front
- Snap in assembly QVT-CLICK 16/20 for wall thickness 1.5 – 2.5 mm
- Snap in assembly QVT-CLICK 25/32/40/50 for wall thickness 1 – 2.5 mm
- Screw in assembly possible for QVT-CLICK sizes 40|1, 50|1 and 50|2 for a wall thickness of 11 mm (depending on the height of the locknut), for QVT-CLICK sizes 16 and 20 for a wall thickness up to 5 mm
- Snap-in and screw-in assembly possible for QVT-CLICK sizes 16, 20, 40|1, 50|1 and 50|4.

### Specifications

Material	Polycarbonate (PC)
Colour	grey (similar RAL 7035)
Flame class	UL 94 V-0, self-extinguishing
IP rating	IP54, with gasket and correct selection of the cable grommets
Temperature	- 30°C to + 100°C (static)
Properties	Halogen-free, silicone-free
Cut-out dimension	Metric sizes

### Accessories

KGM lock nuts	346
---------------	-----



QVT



QVT-CLICK

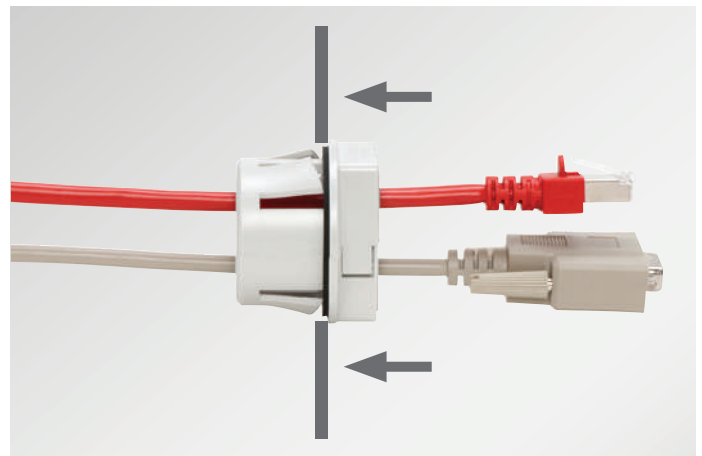

QVT-CLICK: Fast and easy mounting from the front



QVT – reverse view



QVT-CLICK: for screw-in or snap-in assembly



The QVT-CLICK Tool for quick and easy mounting.  
Order No. 61435 (PU: 1)

1  
1.11  
1.12  
1.13  
1.14  
1.15  
1.2  
1.21  
1.22  
1.23  
1.24  
1.25  
1.3

# QVT

## Split cable glands



Description	Type	Order No.	Cable Grommets	Thread Thread length	PU
	QVT 16*	45692	1 × QT	M16 × 1.5 Length: 13 mm	10
	QVT 20**	45695	1 × QT	M20 × 1.5 Length: 13 mm	10
	QVT 25	45702	1 × QT	M25 × 1.5 Length: 13 mm	10
	QVT 32	45711	1 × QT	M32 × 1.5 Length: 13 mm	10
	QVT 40 2	45715	2 × QT	M40 × 1.5 Length: 13 mm	10
	QVT 50 4	45722	4 × QT	M50 × 1.5 Length: 13 mm	10

\* Max. cable diameter of 10 mm | \*\* Max. cable diameter of 11 mm  
 ♦ Cannot be combined with QT-AT-K-M

Single-piece packaging units are available on request.

### Accessories

QT Cable grommets	118 - 121
KVT-EMC Brackets	263
KGM Locknuts	346
ST Plugs	85



Type GMT: Split locknut, p. 346

# QVT-CLICK

## Split pluggable cable glands

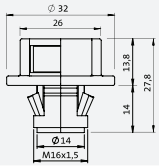
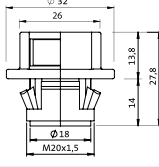
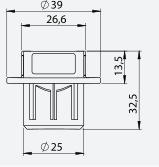
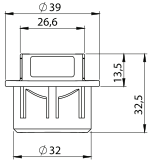
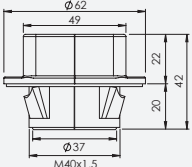
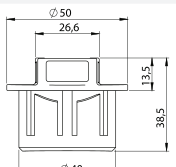
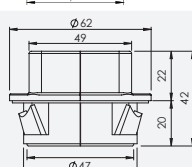
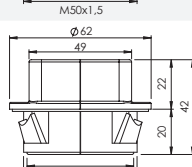

Description	Type	Order No.	Cable Grommets small   large	Cut-out* diameter	Thread Thread length	PU
	QVT-CLICK 16 ** °	45726	1   -	16.2 mm	M16 × 1.5 Length: 13 mm	10
	QVT-CLICK 20 ** °°	45728	1   -	20.4 mm	M20 × 1.5 Length: 13 mm	10
	QVT-CLICK 25	45730	1   -	25.5 mm	-	10
	QVT-CLICK 32	45732	1   -	32.5 mm	-	10
	QVT-CLICK 40 1 **	45736	-   1	40.5 mm	M40 × 1.5 Length: 19 mm	10
	QVT-CLICK 40 2	45734	2   -	40.5 mm	-	10
	QVT-CLICK 50 1 **	45738	-   1	50.5 mm	M50 × 1.5 Length: 19 mm	10
	QVT-CLICK 50 4 **	45740	4   -	50.5 mm	M50 × 1.5 Length: 19 mm	10

\* Please consider any paint layers or powder coatings!  
 \*\* Pluggable and screwable; locknut is not included in the shipment  
 † Sizes M16 und M20 for wall thickness up to 5 mm (screw-in assembly)  
 ° Max. cable diameter of 10 mm  
 °° Max. cable diameter of 11 mm  
 † Cannot be combined with QT-AT-K-M

 Single-piece packaging units are available on request.

1  
1.11  
1.12  
1.13  
1.14  
1.15  
1.2  
1.21  
1.22  
1.23  
1.24  
1.25  
1.3

## 1.23 Split cable entry plates for the QT grommet system



**KEL-QTA are push-in, split IP54 cable entry plates for wall thicknesses from 1.5 to 4 mm. icotek offers several versions for rectangular standard cut-outs as well as for round metric cut-outs. The QTA system offers a large size variety.**

KEL-QTA enable cable routing with or without preassembled connectors. Some types offer a combination of membranes for cable pass-through and the QT grommet system.

Split cable grommets of the QT series are used for the routing of pre-terminated cables with diameters of 1–15 mm within the KEL-QTA. In addition, there are multi-hole grommets for up to 4 lines per slot and special grommets e.g. for ASI cables.

For metric cut-outs M20 – M50

Warranty on pre-terminated cables remains

Split system

KEL-QTA

High cable density, wide variety in cable grommets

Fast and easy assembly

Cut-outs according to industrial standard dimensions



# KEL-QTA | KEL-QTE

Push-in, split cable entry plates for snap-in assembly with IP54 rating

IP54

Push-in, split cable entry plates (IP54) for routing pre-terminated and standard cables utilising split QT grommets or membranes. Suitable for cut-outs for 10- and 24-pin industrial connectors. The compact size KEL-QTA-B is suitable for cut-outs 45.5 x 45.5 mm. The round versions of the KEL-QTA are suitable for cut-outs 32/50 mm in diameter.

The KEL-QTA/KEL-QTE easily routes pre-terminated cables, multi-conductors, hoses or conduits without using any tools for assembly.

The KEL-QTE fits on cut-outs of 20 mm in diameter.

### Advantages & benefits

- Fast and easy assembly without tools
- High cable density by using multi-position grommets
- Simple assembly and disassembly in case of change or service
- Routing of cables with and without connectors in a high density
- Suitable for standard industrial connector cut-outs

### Specifications

Material	Elastomer
Flame class	UL 94 V-0, self-extinguishing
IP rating	IP54, with correct selection of the cable grommets (QT single)
Temperature	- 40°C to + 100°C (static)
Properties	Halogen-free, silicone-free
Cut-out dimension	Metric sizes (QTE)
Frame depth	5 mm (QTA)
Type A:	For wall thickness 1.5 - 2.5 mm
Type B:	For wall thickness 2.8 - 4 mm

### Accessories

QT Cable grommets	118 - 121
ST-B Plugs	171
FP Flange plates	320 - 329



KEL-QTA



KEL-QTE

- 1
- 1.11
- 1.12
- 1.13
- 1.14
- 1.15
- 1.2
- 1.21
- 1.22
- 1.23
- 1.24
- 1.25
- 1.3

 Single-piece packaging units are available on request.

# KEL-QTA

## Split cable entry plates

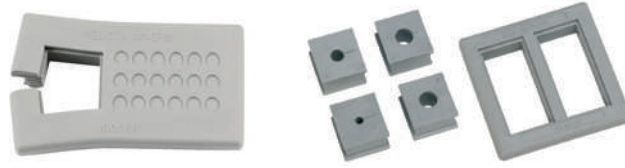

Description	Cut-out   Drilling template	Type	Order No. Type A	Order No. Type B	Cut-out [mm]	Cables	PU
		KEL-QTA 24 2 -DP 18	43642	43643	112 × 36	pre-terminated 2 × 1 - 15 mm  without connector 16 × max. 7 mm 1 × max. 12 mm 1 × max. 16 mm	10
		KEL-QTA 24 4	43644	43645	112 × 36	pre-terminated 4 × 1 - 15 mm	10
		KEL-QTA 10 1-DP 18	43655	43658	65 × 36	pre-terminated 1 × 1 - 15 mm  without connector 18 × max. 5 mm	10
		KEL-QTA 10 2-DP 6	43656	43659	65 × 36	pre-terminated 2 × 1 - 15 mm  without connector 6 × max. 5 mm	10
		KEL-QTA-B4	43660	-	46 × 46	pre-terminated 4 × 1 - 15 mm	10



**i** Single-piece packaging units are available on request.

# KEL-QTA | KEL-QTE

## Split cable entry plates



Description	Type	Order No. Type A	Order No. Type B	Cut-out [mm]	Cables		PU
					pre-terminated	non pre-term.	
	KEL-QTA 32	43632	43636	∅ 32	1x 1 - 15 mm	-	10
	KEL-QTA 50	43622	43626	∅ 50	2x 1 - 15 mm	-	10
	KEL-QTE 20 2.5	43412	-	∅ 20	1x 2.6 - 3.2 mm	1x max. 5.2 mm	10
	KEL-QTE 20 3	43413	-	∅ 20	1x 3.1 - 3.8 mm	1x max. 5.2 mm	10
	KEL-QTE 20 4	43414	-	∅ 20	1x 3.8 - 4.8 mm	1x max. 5.2 mm	10
	KEL-QTE 20 5	43415	-	∅ 20	1x 4.7 - 5.6 mm	1x max. 5.2 mm	10

1  
1.11  
1.12  
1.13  
1.14  
1.15  
1.2  
1.21  
1.22  
**1.23**  
1.24  
1.25  
1.3

**i** Single-piece packaging units are available on request.

## 1.24 Cable grommets for the QT system



Cable grommets QT are used with the following cable entry components:

- KEL-QUICK
- QVT
- QVT-CLICK
- KEL-QTA

In principle, there are two types of cable grommets: split and non-split grommets. The split grommets are suitable for routing cables with connectors, the non-split ones are used for routing non-terminated cables.

Electrical, pneumatic or hydraulic lines as well as corrugated conduits and hoses can be easily routed, sealed and strain relieved using split cable entry systems.

With the split QT grommets, cable diameters from 1 to 29 mm can be covered. With correct assembly, a protection class of IP54 is achieved.

The QTMB grommets allow the routing of cables with diameters that can vary up to 3 mm. By using the QT-DT grommet, the packing density of the cables can be considerably increased and the required installation space considerably reduced.



1  
1.11  
1.12  
1.13  
1.14  
1.15  
1.2  
1.21  
1.22  
1.23  
**1.24**  
1.25  
1.3

## Split cable grommets for cables with connectors



IP54

Split cable grommets, single  
IP54 protection  
for cable diameters 1 to 15 mm

QT

118

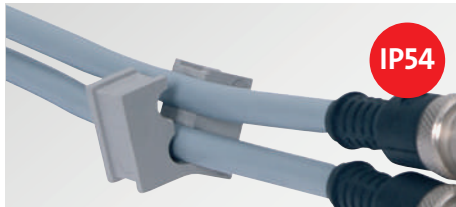

IP54

Split cable grommets, multi and special  
IP54 protection  
for cable diameters 3 to 7 mm

QT multi

118



IP54

Split multi-range cable grommets  
IP54 protection  
for cable diameters 14 to 29 mm

QTMB

119

## Non-split cable grommets for cables without connectors, QT Servicebox



IP54

Membrane cable grommets  
IP54 protection, high cable density  
for cable diameters 6.5 to 14.5 mm

QT-DT

120



IP54

IMAS-CONNECT™  
Modular adapter system  
for the QT system

122 – 132



QT Servicebox  
Service box for cable grommets

121

## Overview of cable entry systems and matching grommets

Product	Split cable grommets for cables with connectors			Non-split cable grommets for cables without connectors	
	QT small single-hole	QT small multi, special	QTMB large multi-range	QT-DT small	QT-DT large
KEL-QUICK	●	●	●	●	●
QVT	●	●	–	●	–
QVT-CLICK	●	●	●	●	●
KEL-QTA	●	●	–	●	–
KEL-QTE	●	●	–	●	–

1  
1.11  
1.12  
1.13  
1.14  
1.15  
1.2  
1.21  
1.22  
1.23  
1.24  
1.25  
1.3

# QT

Split cable grommets, small, single, multi and special, for the QUICK system

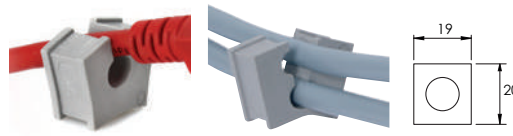

Split cable grommets QT are used with the following cable entry components:

- KEL-QUICK
- QVT
- QVT-CLICK
- KEL-QTA

They are designed for cable diameters from 1 to 15 mm. Blank grommets can seal unused grommet spaces.

When using double or quadruple grommets the cable density of cable entry frames and cable glands can be greatly increased. icotek also offers special cable grommets for e.g. ASI lines.

When installing the small grommets in multiple rows, the flat sides should be facing each other. This allows the flat sides to match up and provide a secure seal.

### Advantages

- Routing of cables with and without connectors
- IP54 rating
- Greatly increased cable density when using double or quadruple grommets
- Strain relief when a suitable cable entry is selected
- Available for a wide range of cable diameters

### Specifications

Material	Elastomer
Flame class	UL 94 V-0, self-extinguishing
IP rating	IP54
Temperature Properties	-40°C to +100°C (static) Halogen-free, silicone-free

### Accessories

ST Plugs	85
----------	----

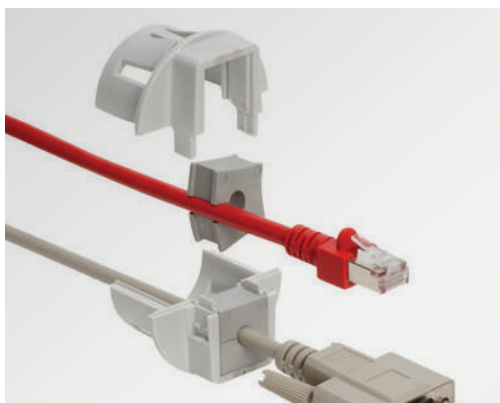

Description	Type	Compatible plugs	Order No.	Clamping range	PU
	QT 1	ST 1	42501	1 – 2 mm	10
	QT 2	ST 2	42502	2 – 3 mm	10
	QT 3	ST 3	42503	3 – 4 mm	10
	QT 4	ST 4	42504	4 – 5 mm	10
	QT 5	ST 5	42505	5 – 6 mm	10
	QT 6	ST 6	42506	6 – 7 mm	10
	QT 7	ST 7	42507	7 – 8 mm	10
	QT 8	ST 8	42508	8 – 9 mm	10
	QT 9	ST 9	42509	9 – 10 mm	10
	QT 10	ST 10	42510	10 – 11 mm	10
	QT 11	ST 11	42511	11 – 12 mm	10
	QT 12	ST 12	42512	12 – 13 mm	10
	QT 13	ST 13	42513	13 – 14 mm	10
	QT 14	ST 14	42514	14 – 15 mm	10
	QT B	–	42540	Blank grommet	10
	QT 2 x				
	QT 2 3	ST 3	42566	2× Ø 3 mm	10
	QT 2 4	ST 4	42568	2× Ø 4 mm	10
	QT 2 5	ST 5	42570	2× Ø 5 mm	10
	QT 2 5.5	–	42571	2× Ø 5.5 mm	10
	QT 2 6	ST 6	42572	2× Ø 6 mm	10
	QT 2 6.5	–	42576	2× Ø 6.5 mm	10
	QT 2 7	ST 7	42578	2× Ø 7 mm	10
	QT 4 x				
	QT 4 3	ST 3	42580	4× Ø 3 mm	10
	QT 4 4	ST 4	42582	4× Ø 4 mm	10
	QT 4 4.5	–	42583	4× Ø 4.5 mm	10
	QT 4 5	ST 5	42584	4× Ø 5 mm	10
	QT 4 5.5	–	42585	4× Ø 5.5 mm	10
	QT 4 6	ST 6	42586	4× Ø 6 mm	10
	QT-ASI 1	–	42573	1× ASI-cable	10
	QT-ASI 2	–	42574	2× ASI-cable	10
	QT tele	–	42575	Telephone cable	10

# QTMB

## Split multi-range grommets, large, for the QUICK system



The multi-range grommet QTMB is used to route pre-terminated cables into the KEL-QUICK system.

The innovative membrane enables the routing of cables with diameters that can vary up to 3 mm.

The QTMB can also be used to insert large cables with a clamping range of 14 to 29 mm.

### Advantages & benefits

- Routing of cables with and without connectors
- IP54 rating
- Strain relief when a suitable cable entry is selected
- Large clamping range
- Only 7 grommets cover a clamping range from 14 to 29 mm
- Innovative wave cut for a better sealing
- Innovative membrane for high flexibility

### Specifications

Material	Elastomer
Flame class	UL 94 V-0, self-extinguishing
IP rating	IP54
Temperature	-40°C to +100°C (static)
Properties	Halogen-free, silicone-free

### Accessories

ST-B Plugs	171
------------	-----

Description	Type	Compatible plugs	Order No.	Clamping range	PU
	QTMB 14-17	ST-B 16	42515	14-17 mm	10
	QTMB 16-19	ST-B 18	42516	16-19 mm	10
	QTMB 18-21	ST-B 20	42517	18-21 mm	10
	QTMB 20-23	ST-B 22	42518	20-23 mm	10
	QTMB 22-25	ST-B 24	42519	22-25 mm	10
	QTMB 24-27	ST-B 26	42520	24-27 mm	10
	QTMB 26-29	ST-B 28	42521	26-29 mm	10
	QTMB-BTG	-	42545	Blank grommet	10

**i** ST-B plugs for the sealing of the perforated membrane

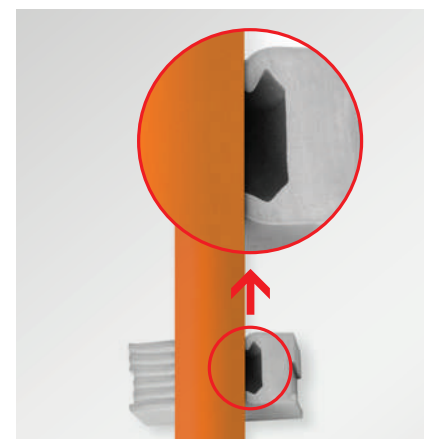
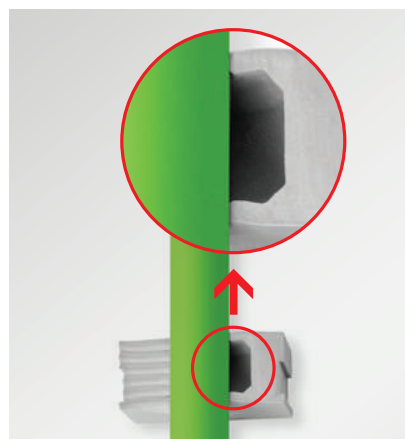
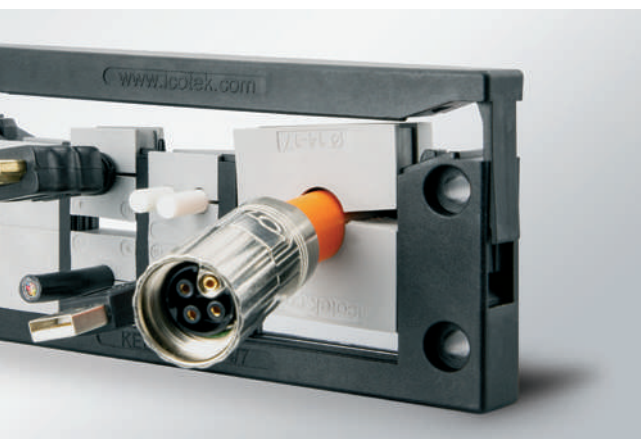

- 1
- 1.11
- 1.12
- 1.13
- 1.14
- 1.15
- 1.2
- 1.21
- 1.22
- 1.23
- 1.24**
- 1.25
- 1.3

# QT-DT

Membrane cable grommets ,  
non-split,  
for the QUICK system



The QT-DT membrane cable grommet enables the routing of cables without connectors. Using the QT-DT grommet considerably increases the cable packing density and decreases the space needed. This new grommet can be used in the KEL-QUICK cable entry frames as well as in the KEL-QTA cable entry plates. Therefore, it is possible to insert cables with and without connectors into one cable entry system.

### Advantages & benefits

- Combination of pre-assembled and non-assembled cables in one cable entry product.
- Very high packing density
- Considerable space and cost savings
- Pre-assembly of individual assemblies possible

### Specifications

Material	Elastomer
Flame class	UL 94 V-0, self-extinguishing
IP rating	IP54
Temperature	-40°C to +100°C (static)
Properties	Halogen-free, silicone-free

### Accessories

ST Plugs	85
----------	----

Description	Type	Order No.	Clamping range	PU
	QT-DT 1	42550	4x max. 6.5 mm	10
	QT-DT 2	42551	2x max. 3.5 mm 2x max. 6.5 mm	10
	QT-DT 3	42552	9x max. 3.5 mm	10
	QT-DT 8	42556	12x max. 6.5 mm 2x max. 12.2 mm	10
	QT-DT 9	42557	15x max. 7.1 mm	10
	QT-DT 10	42558	4x max. 6.5 mm 3x max. 9.5 mm 3x max. 11.3 mm	10
	QT-DT 11	42559	9x max. 9.5 mm	10
	QT-DT 12	42560	4x max. 14.5 mm 1x max. 9.5 mm	10





## QT ServiceBox

Service box  
for cable grommets



### Convenient – everything available right away!

The QT ServiceBox is perfect for installations and service calls. It ensures your QT grommets are readily available.

### Content\*

#### Cable grommets:

- 210 QT for cables 1 - 15 mm
- 10 QTB blank grommets
  - 1 QT-DT 1
  - 1 QT-DT 2
  - 1 QT-DT 3

#### Cable entry components:

- 5 KEL-QTA 50 A cable entry plates
- 1 KEL-QTA 32 A cable entry plate
- 1 KEL-QTA 24|2-DP 18 A cable entry plate
- 1 KEL-QTA 10|1-DP 18 A cable entry plate
- 1 KEL-QUICK 24|10 cable entry frame
- 1 QVT 25 split cable gland
- 1 QVT-CLICK 32 split cable gland

#### Accessories:

- 1 Cable template

\* Subject to alterations



Description	Order No.	PU
QT ServiceBox	88005	1

## KMS

### Cable template

The correct size of the KT grommets can easily be determined by using the cable template.

- Determining the diameter of the cable using the cable template
- Selecting the KT grommets according to the data on the cable template

Cable templates can also be ordered separately.

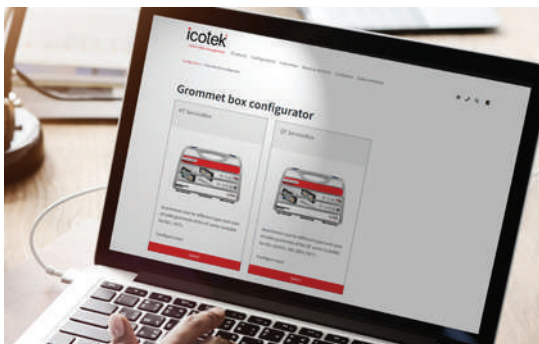

**i** Now the assortment cases for different types and sizes of cable grommets can be configured individually. So the perfect grommets are always at hand: [www.icotek.com/en/config/626044](http://www.icotek.com/en/config/626044)



Description	Order No.	PU
Cable template	39800	1

1  
1.11  
1.12  
1.13  
1.14  
1.15  
1.2  
1.21  
1.22  
1.23  
1.24  
1.25  
1.3

## 1.25 Modular adapter system IMAS-CONNECT™ for the QT system



Simply configure the most individual cable entry in the world

**The IMAS-CONNECT™ adapter system is a modular designed grommet system for mounting metric connectors, PushPull modules, Keystone couplers, hose fittings, pressure compensation elements and much more.**

By utilising the modular adapter system, the cable entry frame becomes a hybrid system. Pre-terminated and standard cables or hoses can be routed. At the same time the system serves as a unique interface for all kinds of connectors. This means that only one interface or cut-out is required for various cables and connections.

The elastomer grommets with polyamide body fit perfectly into the icotek cable entry frames e.g. KEL-U, KEL-ER, KEL-FG and comply with protection classes IP54 to IP66.

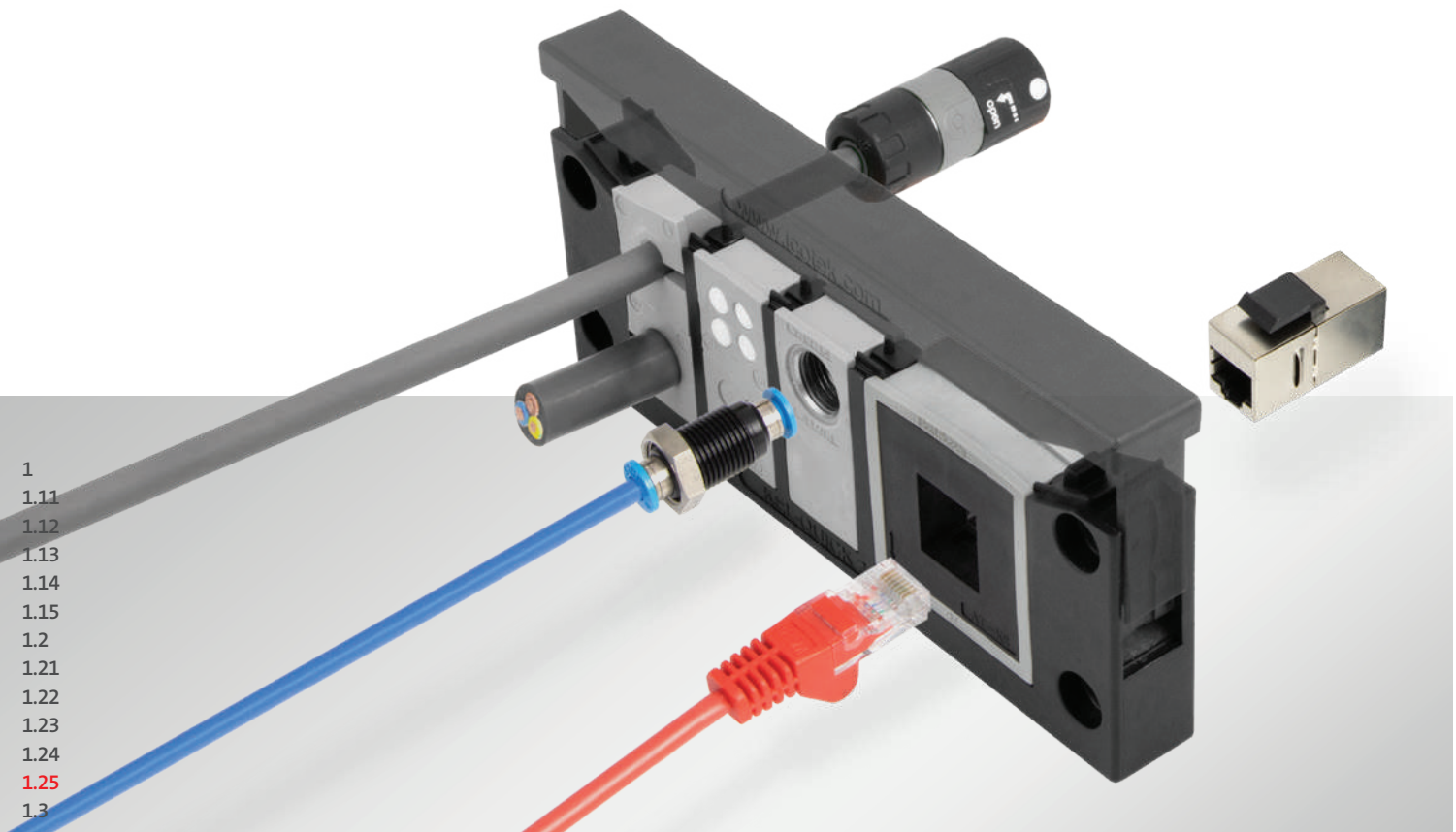

1  
1.11  
1.12  
1.13  
1.14  
1.15  
1.2  
1.21  
1.22  
1.23  
1.24  
1.25  
1.3



Adapter grommet, small with threaded insert

QT-AT-K-M

124

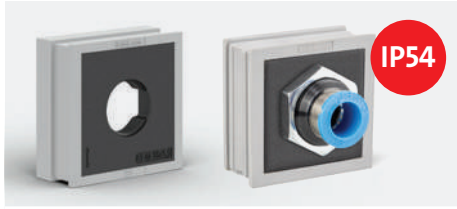

Adapter grommet, large with metric inner thread

QT-AT-M

125



Adapter grommet, blank, large

QT-AT-B

125



Adapter grommet, large for M23 square flange

QT-AT-FL

126



Adapter grommet, large for PushPull connector systems

QT-AT-PP

127



Adapter grommet, large for Keystone couplers

QT-AT-KS

128



Adapter grommet, large for Keystone couplers, with protection cover

QT-AT-KS-AK

129



Adapter grommet, large with mounted Keystone modules, product set

130

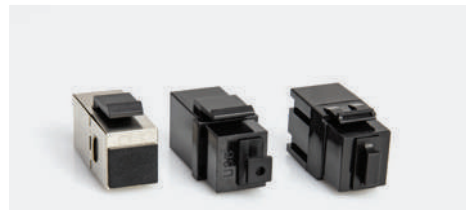

Keystone modules, single bulkhead couplings and accessories

131

- 1
- 1.11
- 1.12
- 1.13
- 1.14
- 1.15
- 1.2
- 1.21
- 1.22
- 1.23
- 1.24
- 1.25
- 1.3

# QT-AT-K-M

## Adapter grommet, small with threaded insert



The QT-AT-K-M grommet is constructed on the basis of a QT cable grommet. The grommets are made of elastomer with a nickel-plated brass body. The QT-AT-K-M grommets are available with inner threads in sizes M5 x 0.5, M8 x 0.5, M8 x 1.0, M12 x 1.0, M12 x 1.5.

By using the QT-AT-K-M adapter grommet, several connectors can be inserted directly into the cable entry frame, e.g. pneumatic bulkhead connectors M12 x 1.0 and M14 x 1.0, metric connectors and pressure compensation elements.

They are compatible with all split icotek cable entry systems that are suitable for QT cable grommets.

### Advantages & benefits

- By using QT-AT-K-M grommets, panel connectors and sockets can be integrated directly into the cable entry system
- Separate cut-outs for connectors are no longer necessary
- Space-saving solution
- Thread sizes M5 to M12 available

### Specifications

Material	Grommet: Elastomer
Body:	nickel-plated brass
Flame class	UL 94 V-0, self-extinguishing
Protection class	IP65 when using correct components
Temperature	-40°C bis +100°C (static)
Properties	Halogen free, silicone free

Type	Order No.	Height x Width x Length [mm]	Thread	Material	PU
QT-AT-K-M 5x0.5	42604	20 x 19 x 17	M5 x 0.5	Brass/Elastomer	5
QT-AT-K-M 8x0.5	42609	20 x 19 x 17	M8 x 0.5	Brass/Elastomer	5
QT-AT-K-M 8x1.0	42605	20 x 19 x 17	M8 x 1.0	Brass/Elastomer	5
QT-AT-K-M 12x1.0	42606	20 x 19 x 17	M12 x 1.0	Brass/Elastomer	5
QT-AT-K-M 12x1.5	42607	20 x 19 x 17	M12 x 1.5	Brass/Elastomer	5



# QT-AT-M | QT-AT-B

## Adapter grommet, large with metric inner thread



QT-AT-M is a grommet (based on large QT grommets) with integrated metric threads, suitable for split icotek cable entry systems. The QT-AT-M grommets are made of elastomer with a polyamide body. QT-AT-M grommets are available with inner threads in sizes M12x1.0, M16x1.5, M20x1.5 and M25x1.5.

The QT-AT-M is ideal for creating an interface for signal, data, power and hybrid connectors by simply screwing them into the QT-AT-M thread. Pressure compensation elements or conduit connectors up to M25x1.5 can also be screwed into the QT-AT-M.

There is also a blank QT-AT-B grommet available. The integrated polyamide body is completely closed on one side. The effective area is 24 x 24 mm, the wall thickness is 6 mm. Custom drill-holes and cut-outs can be made here for e.g. installation of screw mounted hybrid connectors.

icotek also offers screw plugs for sizes M16, M20 and M25 to close the new adapter grommet with the metric internal thread QT-AT-M.

### Advantages & benefits

- By using QT-AT-M grommets, panel connectors and sockets can be integrated directly into the cable entry system
- Separate cut-outs for connectors are no longer necessary
- Space-saving solution
- Thread sizes M12 to M25 available

### Specifications

Material	Grommet: Elastomer Body with thread: Polyamide
Flame class	UL 94 V-0, self-extinguishing
Protection class	IP54 when using correct components
Temperature	-40°C to +100°C (static)
Properties	Halogen free, silicone free



Type	Order No.	Height x Width x Length [mm]	Thread	Material	PU
QT-AT-M 12x1,0	42596	39 x 40 x 17	M12 x 1.0	PA/Elastomer	10
QT-AT-M 16x1,5	42597	39 x 40 x 17	M16 x 1.5	PA/Elastomer	10
QT-AT-M 20x1,5	42598	39 x 40 x 17	M20 x 1.5	PA/Elastomer	10
QT-AT-M 25x1,5	42599	39 x 40 x 17	M25 x 1.5	PA/Elastomer	10
QT-AT-B blank	42600	39 x 40 x 17	–	PA/Elastomer	10

### Screw plugs for QT-AT-M

Type	Order No.	Thread	Material	PU
Screw plug M16 x 1.5	99195	M16	Polyamide	10
Screw plug M20 x 1.5	99196	M20	Polyamide	10
Screw plug M25 x 1.5	99197	M25	Polyamide	10

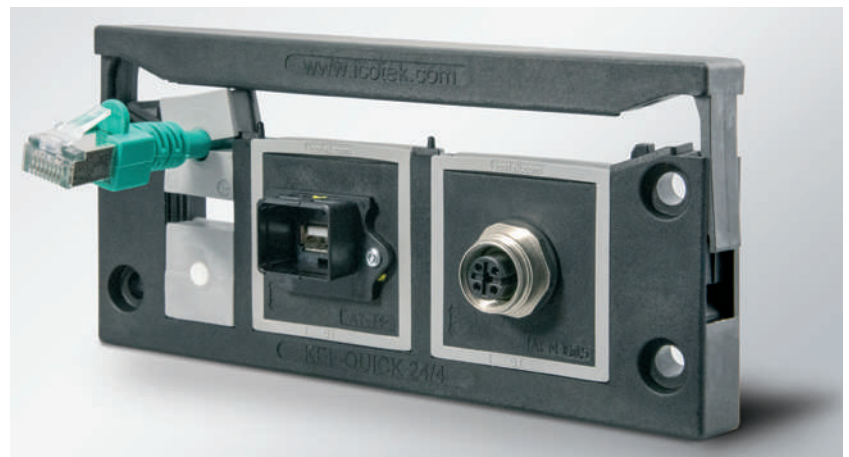

- 1
- 1.11
- 1.12
- 1.13
- 1.14
- 1.15
- 1.2
- 1.21
- 1.22
- 1.23
- 1.24
- 1.25
- 1.3

# QT-AT-FL

## Adapter grommet, large for M23 square flange



The grommet QT-AT-FL is constructed on the basis of a large QT cable grommet. The polyamide body is moulded with elastomer. All square flanges with dimensions 19.8 x 19.8 mm (M23) can be integrated.

The insertion of QT-AT-FL into an icotek cable entry frame enables the routing of cables with and without connectors in combination with the creation of interfaces for M23 connectors within one cable entry system. Separate cut-outs for connectors are no longer necessary.

QT-AT-FL provides ingress protection of up to IP54 (depending on the used flange and connector).

### Advantages & benefits

- By using the QT-AT-FL grommet, connectors can be integrated directly into the cable entry frame
- Separate cut-outs for connectors are no longer necessary
- Space-saving solution
- Cost-saving assembly

### Specifications

Material	Grommet: Elastomer
Body:	Polyamide
Flame class	UL 94 V-0, self-extinguishing
Protection class	IP54, IP55, IP64, IP65
Temperature	-40°C to +100°C (static)
Properties	Halogen free, silicone free

Type	Order No.	Height x width x length [mm]	Material	PU
QT-AT-FL	42608	42 x 41.5 x 19	PA/Elastomer	5

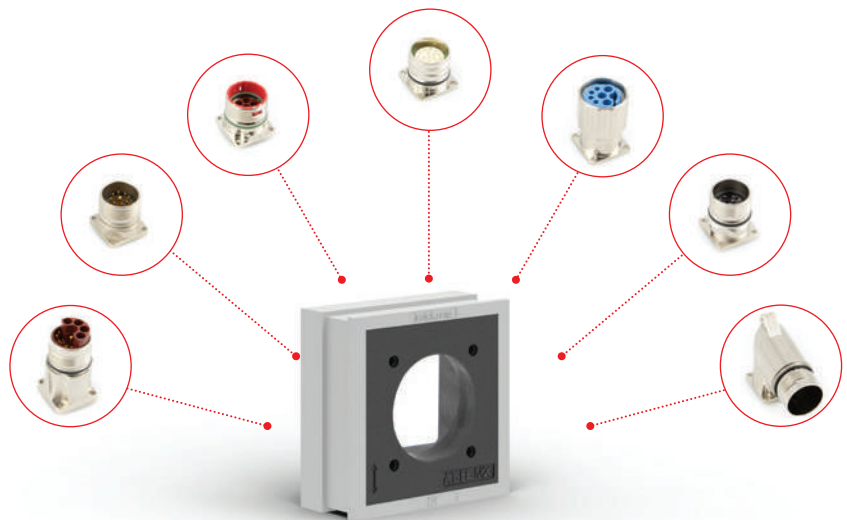

# QT-AT-PP

## Adapter grommet, large for PushPull connector systems



The grommet QT-AT-PP is constructed on the basis of a large QT cable grommet. In this elastomer grommet, a polyamide body is integrated. All modules based on the PushPull system can be inserted into the grommet.

By using the grommet QT-AT-PP, the split cable entry frame can be used to route pre-terminated cables and at the same time it can also be used as an interface for connectors. This can save additional cut-outs and reduce labour costs.

PushPull modules and add-on housings are not included in the scope of delivery.

### Advantages & benefits

- By using QT-AT-PP grommets, panel connectors and sockets can be integrated directly into the cable entry system
- Separate cut-outs for connectors are no longer necessary
- Time saving solution
- Space-saving solution
- Assembly costs are reduced

### Specifications

Material	Grommet: Elastomer Body with thread: Polyamide
Flame class	UL 94 V-0, self-extinguishing
Protection class	IP54 when using correct components
Temperature	-40°C to +100°C (static)
Properties	Halogen free, silicone free

Type	Order No.	Height x width x length [mm]	Material	PU
QT-AT-PP	42602	39 x 40 x 17	PA/Elastomer	10



The module (left) snaps into the rear of the add-on housing mounted on the QT-AT-PP.



- 1
- 1.11
- 1.12
- 1.13
- 1.14
- 1.15
- 1.2
- 1.21
- 1.22
- 1.23
- 1.24
- 1.25
- 1.3

# QT-AT-KS

## Adapter grommet, large for Keystone couplers



The grommet QT-AT-KS is constructed on the basis of a QT cable grommet. In this elastomer grommet, a polyamide body is integrated. All couplers based on the Keystone system can be simply snapped in.

By using the grommet QT-AT-KS, the split cable entry frame can be used to route pre-terminated cables and at the same time it can also be used as an interface for connectors. This can save additional cut-outs and reduce labour costs.

### Advantages & benefits

- By utilising the QT-AT-KS grommet, connectors can be integrated directly into the cable entry frame
- Separate cut-outs for connectors are no longer necessary
- Space-saving solution
- Grommet is suitable for all Keystone couplers
- Snap-in assembly

### Specifications

Material	Grommet: Elastomer Body: Polyamide
Flame class	UL 94 V-0, self-extinguishing
Protection class	IP54 depending on Keystone module and manufacturer
Temperature	-40°C to +100°C (static)
Properties	Halogen free, silicone free

Individual Keystone modules on page 131.

Type	Order No.	Height x width x length [mm]	Material	PU
QT-AT-KS	42601	39 x 40 x 17	PA/Elastomer	10

### Adapter grommet with mounted Keystone modules

Type	Order No.	Height x Width x Length [mm]	Colour Keystone module	PU
QT-AT-KS-USB 3.0	42644	39 x 40 x 17	black	1
QT-AT-KS-USB-C	42647	<b>NEW</b> 39 x 40 x 17	black	1
QT-AT-KS-HDMI	42645	39 x 40 x 17	black	1
QT-AT-KS-CAT6	42646	39 x 40 x 17	silver	1
QT-AT-KS-CAT7	42643	<b>NEW</b> 39 x 40 x 17	silver	1

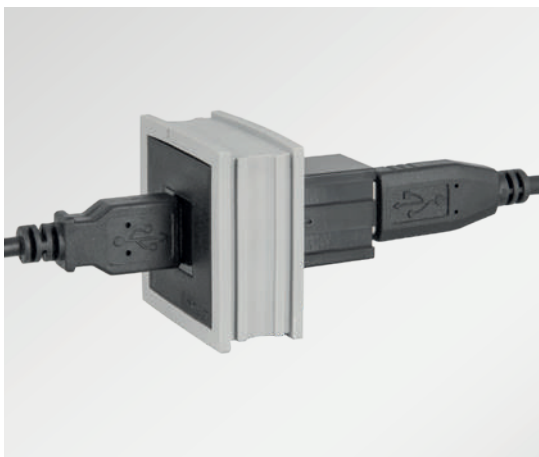

USB-, RJ45 or e.g. HDMI connectors can be plugged in from the front and from the back.



# QT-AT-KS-AK

## Adapter grommet, large for Keystone couplers with protection cover



The polyamide body integrated into the adapter grommet enables all modules based on the Keystone system to be snapped in. The interface can be closed and even sealed using a protective cover on the front.

By using the grommet QT-AT-KS-AK, the split cable entry frame can be used to route pre-terminated cables and at the same time it can also be used as an interface for connectors. This can save additional cut-outs and reduce labour costs.

QT-AT-KS-AK fulfils protection classes up to IP54 when the cover is closed (regardless of the Keystone module type and manufacturer).

### Advantages

- By utilising the QT-AT-KS-AK grommet, connectors can be integrated directly into the cable entry frame
- Separate cut-outs for connectors are no longer necessary
- Space-saving solution
- Easy to install thanks to lockable cover flap
- Cover flap can be secured by sealing

### Specifications

Material	Grommet: Elastomer Body: Polyamide
Flame class	UL 94 V-0, self-extinguishing
Protection class	IP54 (certified according to EN 60529)
Temperature	-40°C to +100°C (static)
Properties	Halogen free, silicone free

Type	Order No.	Height × Width × Length [mm]	Material	PU
QT-AT-KS-AK	42611	39 x 40 x 17	PA/Elastomer/PC	10

### Adapter grommet with mounted Keystone modules and protection cover

Type	Order No.	Height × Width × Length [mm]	Colour	PU
QT-AT-KS-AK-USB 3.0	42648	39 x 40 x 17	black	1
QT-AT-KS-AK-HDMI	42649	39 x 40 x 17	black	1
QT-AT-KS-AK-CAT6	42650	39 x 40 x 17	silver	1
QT-AT-KS-AK-CAT7	42642	39 x 40 x 17	silver	1
QT-AT-KS-AK-USB-C	42651	39 x 40 x 17	black	1



Cover flap can be secured by sealing



- 1
- 1.11
- 1.12
- 1.13
- 1.14
- 1.15
- 1.2
- 1.21
- 1.22
- 1.23
- 1.24
- 1.25
- 1.3

# Adapter grommet with mounted Keystone modules, product set



The adapter grommets type QT-AT-KS are also supplied as a convenient product set with pre-assembled keystone module.

### Advantages & benefits

- By utilising the QT-AT-KS grommet, connectors can be integrated directly into the cable entry frame
- Separate cut-outs for connectors are no longer necessary
- Space-saving solution
- Keystone modules are already pre-assembled

### Specifications

Material	Grommet: Elastomer Body: Polyamide
Flame class	UL 94 V-0, self-extinguishing
Protection class	IP54 depending on Keystone module and manufacturer
Temperature	-40°C to +100°C (static)
Properties	Halogen free, silicone free

Type	Order No.	Height x Width x Length [mm]	Colour Keystone module	PU
QT-AT-KS-USB 3.0	42644	39 x 40 x 17	black	1
QT-AT-KS USB-C	42647 <b>NEW</b>	39 x 40 x 17	black	1
QT-AT-KS-HDMI	42645	39 x 40 x 17	black	1
QT-AT-KS-CAT6	42646	39 x 40 x 17	silver	1
QT-AT-KS-CAT7	42643 <b>NEW</b>	39 x 40 x 17	silver	1



# Keystone modules, single, bulkhead couplings and accessories



The Keystone modules and bulkhead couplings are also available individually for use with the adapter grommets.

## Advantages & benefits

- By utilising the adapter grommets, connectors can be integrated directly into the cable entry frame
- Separate cut-outs for connectors are no longer necessary
- Space-saving solution
- Snap-in assembly

## Specifications

Material	Bulkhead coupling: Brass nickel plated
Flame class	UL 94 V-0, self-extinguishing
Protection class	IP54 depending on module type and manufacturer
Temperature	-40°C to +100°C (static)
Properties	Halogen free, silicone free

## Keystone modules

Type	Order No.	Colour	PU
Keystone module USB 3.0	99204	black	5
Keystone module USB-C	99212 <b>NEW</b>	black	5
Keystone module HDMI	99205	black	5
Keystone module CAT 6	99206	silver	5
Keystone module CAT 7	99213 <b>NEW</b>	silver	5

## Bulkhead couplings

Type	Order No.	suitable for pneumatic hose	Thread	PU
Bulkhead coupling	99210	4 mm	M12 x 1.0	10

## Dust caps

Type	Order No.	suitable for	PU
Dust caps for HDMI	99207	HDMI connectors	5
Dust caps for USB	99208	USB connectors	5
Dust caps for RJ-45	99209	RJ-45 connectors	5



- 1
- 1.11
- 1.12
- 1.13
- 1.14
- 1.15
- 1.2
- 1.21
- 1.22
- 1.23
- 1.24
- 1.25
- 1.3



Available with pre-terminated cut-out for PushPull systems (QT-AT-PP)



Adapter grommet for M23 square flange (QT-AT-FL)



Available with threaded insert (QT-AT-K-M), based on the QT cable grommet

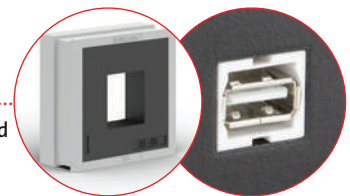

Available with pre-terminated cut-out for Keystone couplers (QT-AT-KS)

Perfect integration into the split cable entry frames

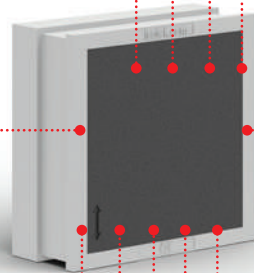

Available with metric inner threads of M12 x 1.0, M16 x 1.5, M20 x 1.5 and M25 x 1.5 (QT-AT-M)

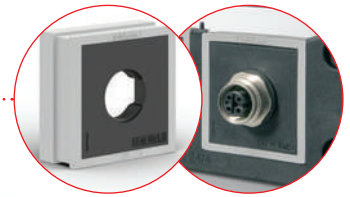

At a high cable density only one cut-out is necessary

Usable area for special cut-outs and drill-holes: 24 x 24 mm; Wall thickness: 6 mm (QT-AT-B)

Elastomer grommet with polyamide body based on the grommet QT large

Available with protection cover for Keystone modules (QT-AT-KS-AK)



Protection class IP54



A series of horizontal dotted lines for writing.

- 1
- 1.11
- 1.12
- 1.13
- 1.14
- 1.15
- 1.2
- 1.21
- 1.22
- 1.23
- 1.24
- 1.25
- 1.3

# 1.3 Cable entry systems for cables with and without connectors – UT System

The universal grommet for frameless mounting is suitable for cables with and without connectors and can be used universally thanks to its variable clamping range. Depending on the housing design, a protection rating of up to IP54 is achieved.



It is used in various types of enclosures made from different materials. These include plastic, metal and die-cast aluminium enclosures.

The diameter of the cables can vary by up to 2 mm

For cables with connectors (UT)

Easy, tool-free installation

Innovative wave cut for greater tightness

Only 6 grommet sizes cover a clamping range from 4 to 11 mm

High contact pressure on the grommet seals and relieves the strain on the cable

For enclosure wall thickness from 1 – 4 mm

With the UT-DT, up to 5 cables without connector can be routed

- 1
- 1.11
- 1.12
- 1.13
- 1.14
- 1.15
- 1.2
- 1.21
- 1.22
- 1.23
- 1.24
- 1.25
- 1.3



Split cable grommet in U-shape  
easy, frameless assembly

UT

136



Cable grommet in U-shape  
non-split,  
easy, frameless assembly

UT-DT

137

## Assembly

Assembly is identical for all housing versions (with/without groove): simply make a U-shaped cut-out in the housing wall and then insert the grommet.

**Caution:** Enclosures behave differently due to their material properties. The contact pressure of the cover, the enclosure material and the wall thickness of the enclosure are decisive.

**Recommendation:** Fit the cut-out on the short side of the enclosure.

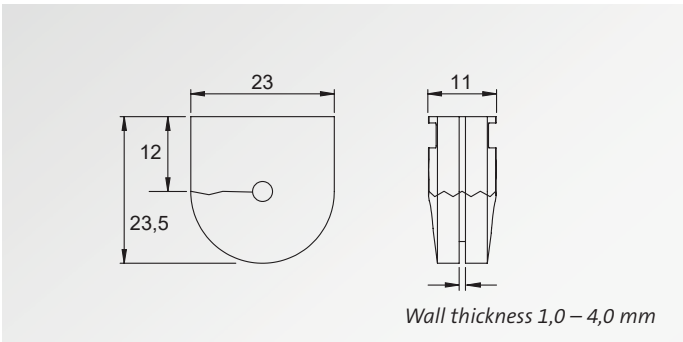

UT

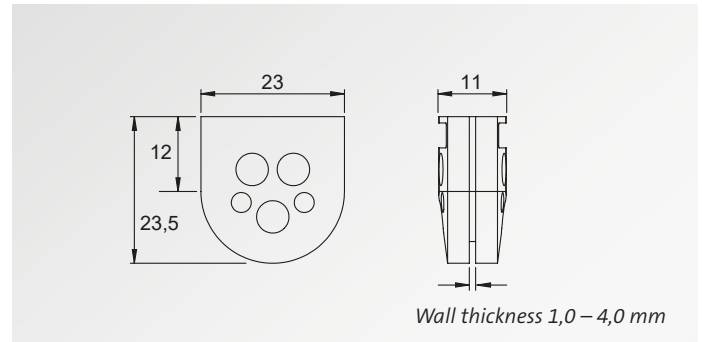

UT-DT

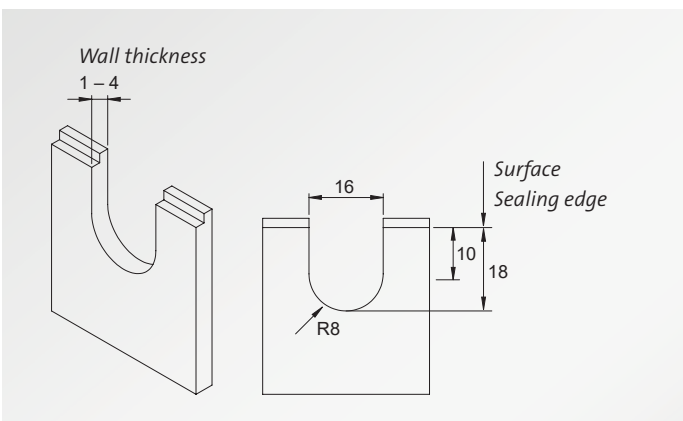

Cut-out with groove  
Housing with tongue and groove system

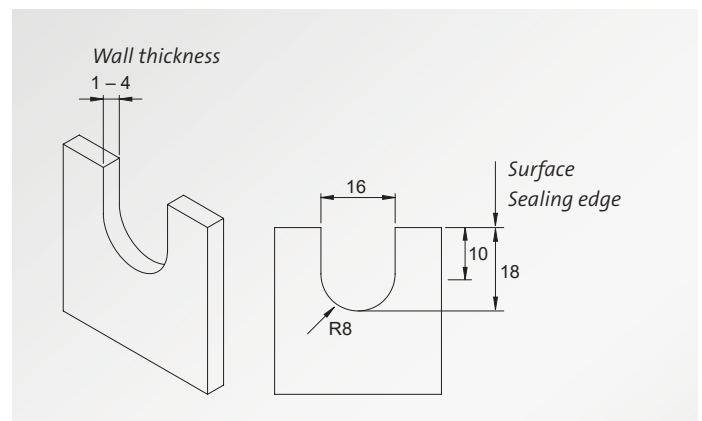

Cut-out without groove  
Housing without tongue and groove system

- 1
- 1.11
- 1.12
- 1.13
- 1.14
- 1.15
- 1.2
- 1.21
- 1.22
- 1.23
- 1.24
- 1.25
- 1.3

# UT

## Split cable grommet in U-shape



With the UT split cable grommet, cables with and without connectors can be easily and cost-effectively inserted into an enclosure and sealed with IP54. All that is required for installation is a U-shaped cut-out into which the fitted grommet is inserted. The UT can be used universally for cables (compressed air hoses, glass fibre tubes, etc.) with a diameter of 4 to 11 mm. The wall thickness of the housing can be from 1 to 4 mm.

Once the grommet has been fitted, it is inserted into the recommended cut-out. The housing cover is then placed on the lower part of the housing. Tightening the cover applies pressure to the grommet and seals and relieves the strain on the cable.

### Advantages

- Only 6 grommet sizes cover a clamping range from 4 to 11 mm
- Cable diameter can vary by up to 2 mm
- Innovative wave cut for greater tightness
- For housing wall thickness from 1 – 4 mm
- Easy, tool-free installation
- Cost-effective solution

### Specifications

Material	Elastomer
Colour	■ grey (similar RAL 7035) ■ black
IP Protection	IP54 (certified acc. to EN 60529)
Flame class	UL 94 V-0, self-extinguishing
Temperature	-40°C to +100°C (static)
Properties	Silicone free, halogen free

Type	Cable diameter	Colour	Order No.	PU
UT 4-6	4 – 6 mm	■ grey	56001	10
UT 4-6	4 – 6 mm	■ black	56101	10
UT 5-7	5 – 7 mm	■ grey	56002	10
UT 5-7	5 – 7 mm	■ black	56102	10
UT 6-8	6 – 8 mm	■ grey	56003	10
UT 6-8	6 – 8 mm	■ black	56103	10
UT 7-9	7 – 9 mm	■ grey	56004	10
UT 7-9	7 – 9 mm	■ black	56104	10
UT 8-10	8 – 10 mm	■ grey	56005	10
UT 8-10	8 – 10 mm	■ black	56105	10
UT 9-11	9 – 11 mm	■ grey	56006	10
UT 9-11	9 – 11 mm	■ black	56106	10
UTB blank grommet	–	■ grey	56000	10
UTB blank grommet	–	■ black	56100	10

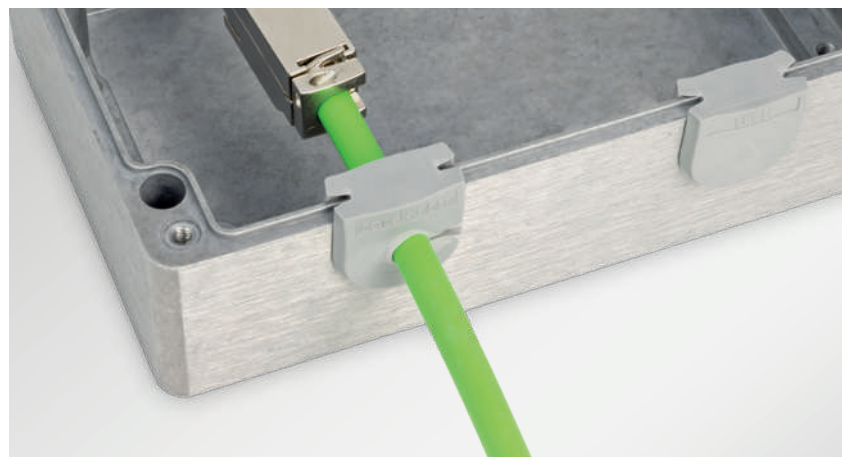



# UT-DT

## Membrane cable grommet in U-shape, non-split



The UT-DT membrane cable grommet is used to route non-assembled cables. It can be used wherever the use of the UT cable grommets is possible. Its use allows the packing density of the routed cables to be increased. The wall thickness of the housing can range from 1.0 to 4.0 mm. It is used in various types of housings made from different materials. These include plastic, metal and die-cast aluminium housings.

### Advantages

- Up to five cables can be routed with one grommet
- For housing wall thickness from 1 – 4 mm
- Easy, tool-free installation
- Cost-effective solution

### Specifications

Material	Elastomer
Colour	■ grey (similar RAL 7035) ■ black
IP Protection	IP54 (certified acc. to EN 60529)
Flame class	UL 94 V-0, self-extinguishing
Temperature	-40°C to +100°C (static)
Properties	Silicone free, halogen free

	Type	Cable diameter	Colour	Order No.	PU
	UT-DT 1	1× max. 11 mm	■ grey	56020	10
	UT-DT 1	1× max. 11 mm	■ black	56120	10
	UT-DT 4	2× max. 6,4 mm 1× max. 4,2 mm 1× max. 3,2 mm	■ grey	56021	10
	UT-DT 4	2× max. 6,4 mm 1× max. 4,2 mm 1× max. 3,2 mm	■ black	56121	10
	UT-DT 5	3× max. 5,2 mm 2× max. 3,2 mm	■ grey	56022	10
	UT-DT 5	3× max. 5,2 mm 2× max. 3,2 mm	■ black	56122	10

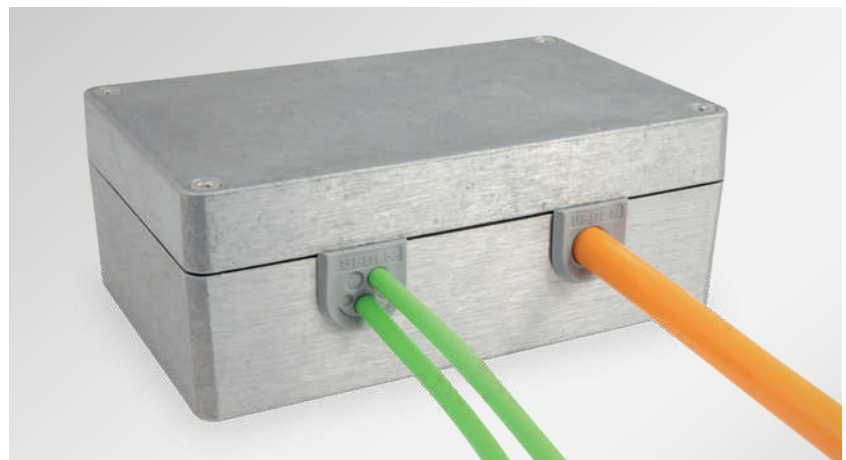

- 1
- 1.11
- 1.12
- 1.13
- 1.14
- 1.15
- 1.2
- 1.21
- 1.22
- 1.23
- 1.24
- 1.25
- 1.3



# Cable entry systems for cables without connectors

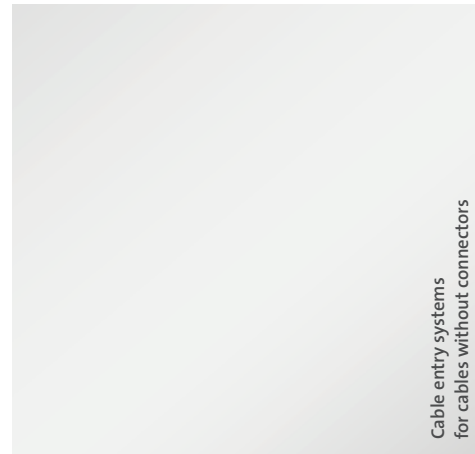
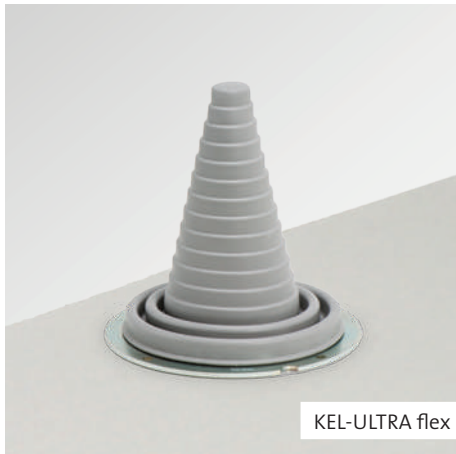
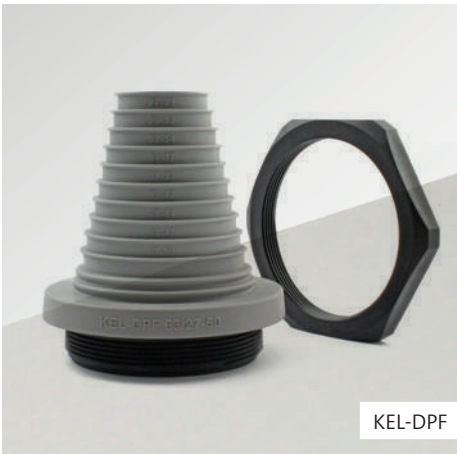
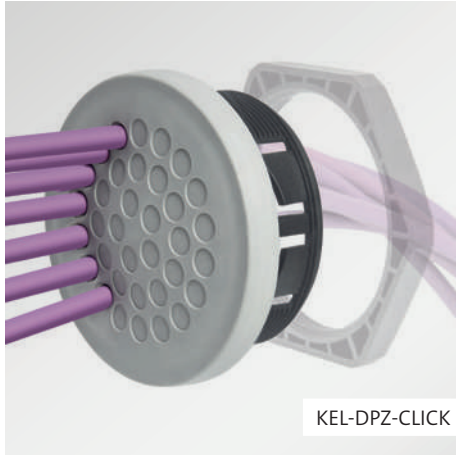

Cable entry systems  
for cables without connectors

2
2.1
2.2
2.3
2.4
2.5
2.6
2.7
2.8

## 2 Cable entry systems for cables without connectors

For routing cables without connectors icotek offers a wide range of products with a lot of advantages and benefits in comparison to conventional cable glands.

The compact, slim and innovative design of the membrane-based cable entry plates offer a professional appearance and high ingress protection ratings up to IP68/UL type 4X.

Due to high cable densities especially suitable for applications where a lot of cables have to be entered through a small space.

For routing rigid and large diameter cables icotek offers highly flexible conical cable entry grommets with high protection ratings.

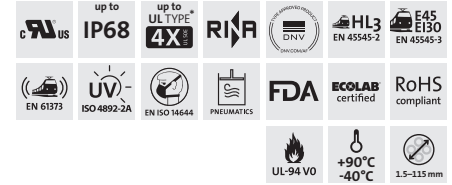

- 2
- 2.1
- 2.2
- 2.3
- 2.4
- 2.5
- 2.6
- 2.7
- 2.8

# ProductFinder

Product	IP54	IP64	IP65	IP66	IP68	UL TYPE 12	UL TYPE 4X*	Strain relief	Cable Ø mm min   max	Max. no. of cables	Page
KEL-DPU 24	●	●	●	●	●	●	●	●	3.2 – 20.5	32	145 – 147
KEL-DPZ 24	●	●	●	●		●		●	2.5 – 22	121	149 – 150
KEL-DPZ 16	●	●	●	●				●	3.2 – 16.2	34	151
KEL-DPZ 10	●	●	●	●				●	3.2 – 12	26	152
KEL-DPZ 6	●	●	●	●				●	2.5 – 8	27	153
KEL-DPZ-B	●	●	●	●		●		●	3.2 – 22	25	154
KEL-DPZ-E	●	●	●	●		●		●	3.2 – 12	21	154
KEL-DPZ-KL	●	●	●			●		●	3.2 – 22	72	172 – 173
KEL-DPZ round	●	●	●	●	●	●	●	●	1.5 – 22.2	78	156 – 157
KEL-DPZ-CLICK round	●	●	●	●	●			●	1.5 – 22.2	78	158 – 159
KEL-DPZ CR	●	●	●	●	●	●	●	●	1.5 – 22.2	78	407 – 409
KEL-DPR	●	●	●					●	1 – 16.1	48	160 – 161
KEL-DP 24	●	●				●			max. 16.1	48	163
KEL-DP 16	●	●				●			max. 12.6	26	164
KEL-DP 10	●	●				●			max. 12.6	26	165
KEL-DP 6	●	●				●			max. 16.1	25	166
KEL-DP-E	●	●				●			max. 12.1	21	167
KEL-DP round	●	●	●			●			max. 22.5	35	168 – 170
KEL-DPU-HD	●	●	●	●	●			●	3.2 – 20.5	32	426 – 427
KEL-DPZ-HD round	●	●	●	●	●	●	●	●	1.5 – 22.2	78	428 – 429
KEL-SCDP-TR	●	●	●						5 – 52	5	178 – 179
KEL-SCDP/-RW	●	●	●						5 – 36	1	180 – 181
KEL-DPF	●	●	●	●	●	●	●	●	3 – 70	1	182 – 183
KEL-JUMBO flex	●					●		●	27 – 68	1	184
KEL-ULTRA flex	●	●	●	●		●		●	25 – 115	1	185

Further details on certifications and technical specifications can be found on the product pages.

\*4X for indoor use only

## 2.1 – 2.6 Cable entry plates for cables without connectors



High cable density

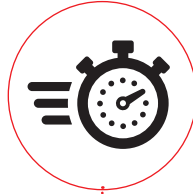

Fast and easy, partially tool-free assembly



Plugs for membranes ST-B

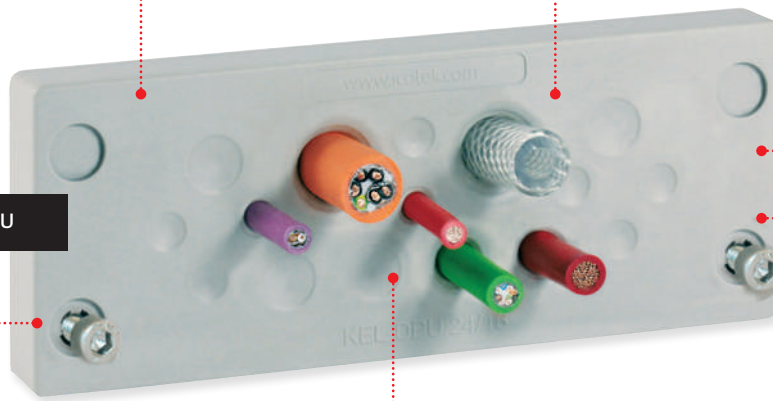

KEL-DPU

Compact, space-saving design

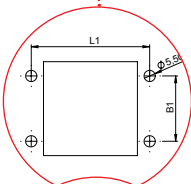

Many cut-outs according to industrial standard dimensions

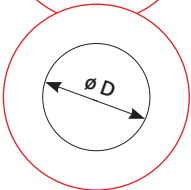

For metric cut-outs M20 – M63 (KEL-DPZ/KEL-DP round)

IP64 to IP68 rated protection, double cable sealing on front and back (KEL-DPU/KEL-DPZ)

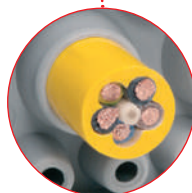

Flexible clamping range

- 2
- 2.1
- 2.2
- 2.3
- 2.4
- 2.5
- 2.6
- 2.7
- 2.8

**i** Single-piece packaging units are available on request.



**Cable entry plates**  
for screw-in or snap-in assembly,  
high strain relief,  
for standard cut-outs

KEL-DPU 24

144 – 147



**Cable entry plates**  
for screw-in assembly,  
strain relief,  
for standard cut-outs

KEL-DPZ series

148 – 155



**Cable entry plates**  
for screw-in assembly,  
strain relief,  
for standard cut-outs

KEL-DPZ-KL

172 – 173



**Cable entry plates, round**  
for screw-in assembly,  
with thread and locknut, M25 – M63,  
strain relief

KEL-DPZ round series

156 – 157



**Cable entry plates**  
for snap-in or screw-in assembly  
with a locknut,  
M25 – M63

KEL-DPZ-CLICK series

158 – 159



**Cable entry plates**  
for screw-in assembly

KEL-DPR

160 – 161



**Cable entry plates**  
for plug-in assembly without tools

KEL-DP series

162 – 167



**Cable entry plates, round**  
plug-in mounting,  
M20 – M50

KEL-DP round series

168 – 170



**Plugs for membranes**  
and multi-range cable grommets  
ST-B

**Cover plugs**  
for cable entry plates

171

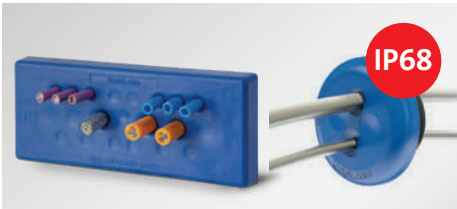

**Cable entry plates**  
for screw-in or snap-in assembly,  
high strain relief  
*Hygienic Design Line*

KEL-DPU-HD

426 – 429



**Thread extension**  
for cable glands and cable entry plates  
M32, M50, M63

TE-M

334 – 337



**90° Cable entry adapter**  
for cable entry systems

KEA

340 – 343

2  
2.1  
2.2  
2.3  
2.4  
2.5  
2.6  
2.7  
2.8

## KEL-DPU

### Cable entry plates with high strain relief with IP66/IP68 rating



KEL-DPU entry plates are designed to route and seal cables without connectors (from 3.2 mm to 20.5 mm in diameter) in limited space with IP66/IP68\*\*/up to UL type 4X ratings. The KEL-DPU is particularly characterised by its solid robust frame and the increased strain relief of the routed cables.

The KEL-DPU 24 matches exactly the cut-out dimensions of 24-pin standard industrial connectors. For optional screw assembly just pierce the membranes on the integrated screw holes with the screw itself.

The assembly of the KEL-DPU with cables or pneumatic hoses can be done quick and easy. Simply make a small hole in the thin membrane and push the cables through. ST-B Plugs can be used for sealing pierced membranes if cables have been removed.

The version with threaded bushings enables the cable entry plate to be screwed onto the housing from the inside out. This protects against vandalism and tampering with the housing from the outside.

#### Advantages & benefits

- Dual cable sealing with IP66/IP68\*\*/up to UL type 4X
- Snap or screw mounting possible
- High strength and stability
- High strain relief
- Fast and easy assembly
- Very high cable density
- For industrial standard cut-outs
- Hygienic design – free of dirt-collecting recesses



Membrane on front



ST-B plug for the sealing of the perforated membrane



Also available in black



Conical shape on back provides additional sealing and strain relief

**i** This product range is also available as a KEL-DPU-HD version for the food sector, see pages 426 – 429. Single-piece packaging units are available on request.



# KEL-DPU

Cable entry plates  
with high strain relief

KEL-DPU 24



## Specifications

Material	Frame: Polypropylene (PP) Sealing plate: Elastomer
Colour	■ grey (similar RAL 7035) ■ black
Flame class	UL 94 V-0, self-extinguishing
IP rating	IP65/IP66/IP67/IP68** (certified acc. to EN 60529)
UL type rating	UL type 12 (acc. to UL 50E) UL type 4X (acc. to UL 50E)
Temperature	-40°C to +100°C (static)
Properties	Halogen-free, silicone-free
Plate depth	14 mm
For wall thickness	1.5 – 2 mm (snap-in mounting)

## Accessories

ST-B Plugs	171
KEL-EMC-PF Cable collectors	262
FP Flanged plates	320 - 329
KEA Cable Entry Adapter	340 - 343



Resistant against industrial detergents (ECOLAB certified)



Tool-free assembly possible due to snap-in function



Also available with threaded bushings



Can be combined with 90° cable entry adapter KEA

- 2
- 2.1
- 2.2
- 2.3
- 2.4
- 2.5
- 2.6
- 2.7
- 2.8

\*4X for indoor use only | \*\* IP67/IP68 only when screw mounted

# KEL-DPU

## Cable entry plates with high strain relief

### KEL-DPU 24



Description	Cut-out   Drilling template	Type	Cut-out mm	Number of cables	Order No.	PU
		KEL-DPU 24 13	36 x 112 mm	10x 3.2 - 6.3 mm	<input type="checkbox"/> 43940 <input checked="" type="checkbox"/> 50940	10
		KEL-DPU 24 13 with threaded bushings M4	36 x 112 mm	3x 16 - 20.5 mm	<input type="checkbox"/> 43940.400 <input checked="" type="checkbox"/> 50940.400	10
		KEL-DPU 24 14	36 x 112 mm	5x 3.2 - 6.3 mm 2x 4 - 7.5 mm	<input type="checkbox"/> 43944 <input checked="" type="checkbox"/> 50944	10
		KEL-DPU 24 14 with threaded bushings M4	36 x 112 mm	3x 5.5 - 10.5 mm 1x 8 - 12.5 mm 3x 12 - 16.2 mm	<input type="checkbox"/> 43944.400 <input checked="" type="checkbox"/> 50944.400	10
		KEL-DPU 24 16	36 x 112 mm	8x 3.2 - 5.5 mm 6x 5 - 8.5 mm	<input type="checkbox"/> 43936 <input checked="" type="checkbox"/> 50936	10
		KEL-DPU 24 16 with threaded bushings M4	36 x 112 mm	2x 9.5 - 14.5 mm	<input type="checkbox"/> 43936.400 <input checked="" type="checkbox"/> 50936.400	10
		KEL-DPU 24 16-1	36 x 112 mm	2x 3.2 - 6.3 mm 9x 4 - 7.5 mm	<input type="checkbox"/> 43932 <input checked="" type="checkbox"/> 50932	10
		KEL-DPU 24 16-1 with threaded bushings M4	36 x 112 mm	1x 5.5 - 10.5 mm 1x 8 - 12.5 mm 3x 12 - 16.2 mm	<input type="checkbox"/> 43932.400 <input checked="" type="checkbox"/> 50932.400	10



Also available in black

**i** This product range is also available as a KEL-DPU-HD version for the food sector, see pages 426 – 429. Single-piece packaging units are available on request.

# KEL-DPU

## Cable entry plates with high strain relief

### KEL-DPU 24



Description	Cut-out   Drilling template	Type	Cut-out mm	Number of cables	Order No.	PU
		KEL-DPU 24 17	36 x 112 mm	4 x 3.2 - 6.3 mm 2 x 4 - 7.5 mm 1 x 5.5 - 10.5 mm 10 x 8 - 12.5 mm	<input type="checkbox"/> 43934 <input checked="" type="checkbox"/> 50934	10
		KEL-DPU 24 17 with threaded bushings M4	36 x 112 mm		<input type="checkbox"/> 43934.400 <input checked="" type="checkbox"/> 50934.400	10
		KEL-DPU 24 20	36 x 112 mm	12 x 3.2 - 5.5 mm 8 x 5 - 10.5 mm	<input type="checkbox"/> 43938 <input checked="" type="checkbox"/> 50938	10
		KEL-DPU 24 20 with threaded bushings M4	36 x 112 mm		<input type="checkbox"/> 43938.400 <input checked="" type="checkbox"/> 50938.400	10
		KEL-DPU 24 21	36 x 112 mm	1 x 3.2 - 6.3 mm 14 x 4 - 7.5 mm 4 x 5.5 - 10.5 mm 2 x 8 - 12.5 mm	<input type="checkbox"/> 43930 <input checked="" type="checkbox"/> 50930	10
		KEL-DPU 24 21 with threaded bushings M4	36 x 112 mm		<input type="checkbox"/> 43930.400 <input checked="" type="checkbox"/> 50930.400	10
		KEL-DPU 24 32	36 x 112 mm	32 x 3.2 - 6.3 mm	<input type="checkbox"/> 43942 <input checked="" type="checkbox"/> 50942	10
		KEL-DPU 24 32 with threaded bushings M4	36 x 112 mm		<input type="checkbox"/> 43942.400 <input checked="" type="checkbox"/> 50942.400	10

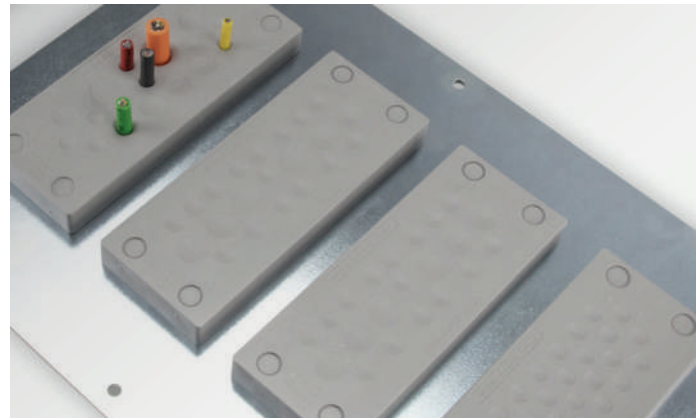

2  
2.1  
2.2  
2.3  
2.4  
2.5  
2.6  
2.7  
2.8

# KEL-DPZ series

## Cable entry plates with IP66 rating



KEL-DPZ cable entry plates are designed to route and seal a large number of cables without connectors, hoses or fibre optics (from 2.5 mm to 22 mm in diameter) in limited space. The KEL-DPZ products are a cost and time saving alternative to traditional cable glands.

The assembly of the KEL-DPZ with cables or pneumatic hoses can be done quick and easy. Simply make a small hole in the thin membrane, push the cables through. The KEL-DPZ provides strain relief and protection up to IP66/UL type 12.

The KEL-DPZ matches exactly the cut-out dimensions of 6-, 10- 16- and 24-pin standard industrial connectors. The size KEL-DPZ-B fits on cut-outs 46 × 46 mm. The very compact size KEL-DPZ-E is designed for routing cables in very small space. Through a cut-out of only 18 × 112 mm, up to 21 cables can be easily routed and sealed.

Especially for Rittal KL and KX terminal boxes the size KEL-DPZ-KX/KL was created. It was designed for routing up to 72 cables through the pre-cut standard cut-out. The self-tapping screws (M4) required for assembly are included in the scope of delivery. ST-B Plugs can be used for sealing pierced membranes if cables have been removed.

The version with threaded bushings enables the cable entry plate to be screwed onto the housing from the inside out. This protects against vandalism and tampering with the housing from the outside.

### Advantages & benefits

- Dual sealing acc. to IP65/IP66/UL type 12
- Fast and easy assembly
- High cable density
- High strain relief
- Hygienic design

### Specifications

Material	Frame: Polyamide (PA) KEL-DPZ 6: Stainless steel V2A Sealing plate: Elastomer
Colour	■ grey (similar RAL 7035) ■ black
Flame class	UL 94 V-0, self-extinguishing
IP rating	IP65/IP66 (certified acc. to EN 60529)
UL type rating	UL type 12 (acc. to UL 50E)
Temperature	- 40°C to + 100°C (static)
Properties	Halogen-free, silicone-free
Plate depth	14 mm

### Accessories

ST-B Plugs	171
KEL-EMC-PF Cable collectors	262
FP Flanged plates	320 - 329



Also available in black



Also available with threaded bushings



Membrane on front



Conical shape on back provides additional sealing and strain relief



Can be combined with 90° cable entry adapter KEA

# KEL-DPZ

## Cable entry plates

### KEL-DPZ 24



Description	Cut-out   Drilling template	Type	Cut-out mm	Number of cables	Order No.	PU
		KEL-DPZ 24 14	36 x 112 mm	10x 3.2 - 6.5 mm 4x 16 - 22 mm	<span style="background-color: #cccccc;">■</span> 43700 <span style="background-color: #333333;">■</span> 50700	10
		KEL-DPZ 24 14 with threaded bushings M4	36 x 112 mm	10x 3.2 - 6.5 mm 4x 16 - 22 mm	<span style="background-color: #cccccc;">■</span> 43700.400 <span style="background-color: #333333;">■</span> 50700.400	10
		KEL-DPZ 24 15	36 x 112 mm	15x 7.2 - 12 mm	<span style="background-color: #cccccc;">■</span> 43720 <span style="background-color: #333333;">■</span> 50720	10
		KEL-DPZ 24 15 with threaded bushings M4	36 x 112 mm	15x 7.2 - 12 mm	<span style="background-color: #cccccc;">■</span> 43720.400 <span style="background-color: #333333;">■</span> 50720.400	10
		KEL-DPZ 24 16	36 x 112 mm	8x 3.2 - 6.5 mm 4x 5 - 9.7 mm 2x 9 - 16.2 mm 2x 16 - 22 mm	<span style="background-color: #cccccc;">■</span> 43725 <span style="background-color: #333333;">■</span> 50725	10
		KEL-DPZ 24 16 with threaded bushings M4	36 x 112 mm	8x 3.2 - 6.5 mm 4x 5 - 9.7 mm 2x 9 - 16.2 mm 2x 16 - 22 mm	<span style="background-color: #cccccc;">■</span> 43725.400 <span style="background-color: #333333;">■</span> 50725.400	10
		KEL-DPZ 24 17	36 x 112 mm	6x 3.2 - 6.5 mm 6x 5 - 10.2 mm 5x 9 - 16.2 mm	<span style="background-color: #cccccc;">■</span> 43705 <span style="background-color: #333333;">■</span> 50705	10
		KEL-DPZ 24 17 with threaded bushings M4	36 x 112 mm	6x 3.2 - 6.5 mm 6x 5 - 10.2 mm 5x 9 - 16.2 mm	<span style="background-color: #cccccc;">■</span> 43705.400 <span style="background-color: #333333;">■</span> 50705.400	10
		KEL-DPZ 24 25	36 x 112 mm	12x 3.2 - 6.5 mm 7x 4.8 - 9.7 mm 6x 7.5 - 12 mm	<span style="background-color: #cccccc;">■</span> 43710 <span style="background-color: #333333;">■</span> 50710	10
		KEL-DPZ 24 25 with threaded bushings M4	36 x 112 mm	12x 3.2 - 6.5 mm 7x 4.8 - 9.7 mm 6x 7.5 - 12 mm	<span style="background-color: #cccccc;">■</span> 43710.400 <span style="background-color: #333333;">■</span> 50710.400	10
		KEL-DPZ 24 26	36 x 112 mm	26x 5.0 - 10.2 mm	<span style="background-color: #cccccc;">■</span> 43711 <span style="background-color: #333333;">■</span> 50711	10
		KEL-DPZ 24 26 with threaded bushings M4	36 x 112 mm	26x 5.0 - 10.2 mm	<span style="background-color: #cccccc;">■</span> 43711.400 <span style="background-color: #333333;">■</span> 50711.400	10

2  
2.1  
**2.2**  
2.3  
2.4  
2.5  
2.6  
2.7  
2.8

**i** The KEL-DPZ series is also available as a cleanroom version, see from page 428.  
Single-piece packaging units are available on request.

# KEL-DPZ

## Cable entry plates

### KEL-DPZ 24



Description	Cut-out   Drilling template	Type	Cut-out mm	Number of cables	Order No.	PU
		KEL-DPZ 24 32	36 x 112 mm	21x 3.2 - 6.5 mm 8x 5 - 10.2 mm 3x 7.5 - 12 mm	<span style="background-color: #cccccc; border: 1px solid black; padding: 2px;">43730</span> <span style="background-color: #333333; border: 1px solid black; padding: 2px;">50730</span>	10
		KEL-DPZ 24 32 with threaded bushings M4	36 x 112 mm	21x 3.2 - 6.5 mm 8x 5 - 10.2 mm 3x 7.5 - 12 mm	<span style="background-color: #cccccc; border: 1px solid black; padding: 2px;">43730.400</span> <span style="background-color: #333333; border: 1px solid black; padding: 2px;">50730.400</span>	10
		KEL-DPZ 24 42	36 x 112 mm	42x 3.2 - 6.5 mm	<span style="background-color: #cccccc; border: 1px solid black; padding: 2px;">43715</span> <span style="background-color: #333333; border: 1px solid black; padding: 2px;">50715</span>	10
		KEL-DPZ 24 42 with threaded bushings M4	36 x 112 mm	42x 3.2 - 6.5 mm	<span style="background-color: #cccccc; border: 1px solid black; padding: 2px;">43715.400</span> <span style="background-color: #333333; border: 1px solid black; padding: 2px;">50715.400</span>	10
		KEL-DPZ 24 121	36 x 112 mm	119x 1.5 - 2.6 mm 2x 2.5 - 5 mm	<span style="background-color: #cccccc; border: 1px solid black; padding: 2px;">43735</span> <span style="background-color: #333333; border: 1px solid black; padding: 2px;">50735</span>	10
		KEL-DPZ 24 121 with threaded bushings M4	36 x 112 mm	119x 1.5 - 2.6 mm 2x 2.5 - 5 mm	<span style="background-color: #cccccc; border: 1px solid black; padding: 2px;">43735.400</span> <span style="background-color: #333333; border: 1px solid black; padding: 2px;">50735.400</span>	10

\* Only valid for grey product types



High cable density



KEL-DPZ 16

# KEL-DPZ

## Cable entry plates

### KEL-DPZ 16



Description	Cut-out   Drilling template	Type	Cut-out mm	Number of cables	Order No.	PU
		KEL-DPZ 16 11	36 x 86 mm	11× 7.5 - 12 mm	43815	10
		KEL-DPZ 16 11 with threaded bushings M4	36 x 86 mm	11× 7.5 - 12 mm	43815.400	10
		KEL-DPZ 16 14	36 x 86 mm	5× 3.2 - 6.5 mm 5× 5 - 10.2 mm 4× 9 - 16.2 mm	43816	10
		KEL-DPZ 16 14 with threaded bushings M4	36 x 86 mm	5× 3.2 - 6.5 mm 5× 5 - 10.2 mm 4× 9 - 16.2 mm	43816.400	10
		KEL-DPZ 16 20	36 x 86 mm	11× 3.2 - 6.5 mm 5× 5 - 10.2 mm 4× 7.5 - 12 mm	43817	10
		KEL-DPZ 16 20 with threaded bushings M4	36 x 86 mm	11× 3.2 - 6.5 mm 5× 5 - 10.2 mm 4× 7.5 - 12 mm	43817.400	10
		KEL-DPZ 16 25	36 x 86 mm	16× 3.2 - 6.5 mm 6× 5 - 10.2 mm 3× 7.5 - 12 mm	43818	10
		KEL-DPZ 16 25 with threaded bushings M4	36 x 86 mm	16× 3.2 - 6.5 mm 6× 5 - 10.2 mm 3× 7.5 - 12 mm	43818.400	10
		KEL-DPZ 16 34	36 x 86 mm	34× 3.2 - 6.5 mm	43819	10
		KEL-DPZ 16 34 with threaded bushings M4	36 x 86 mm	34× 3.2 - 6.5 mm	43819.400	10

- 2
- 2.1
- 2.2
- 2.3
- 2.4
- 2.5
- 2.6
- 2.7
- 2.8

**i** The KEL-DPZ series is also available as a cleanroom version, see from page 428.  
Single-piece packaging units are available on request.

# KEL-DPZ

## Cable entry plates

### KEL-DPZ 10



Description	Cut-out   Drilling template	Type	Cut-out mm	Number of cables	Order No.	PU
		KEL-DPZ 10 8	65 x 36 mm	8 x 7.5 - 12 mm	43800	10
		KEL-DPZ 10 8 with threaded bushings M4	65 x 36 mm	8 x 7.5 - 12 mm	43800.400	10
		KEL-DPZ 10 14	65 x 36 mm	14 x 5 - 10.2 mm	43801	10
		KEL-DPZ 10 14 with threaded bushings M4	65 x 36 mm	14 x 5 - 10.2 mm	43801.400	10
		KEL-DPZ 10 15	65 x 36 mm	5 x 3.2 - 6.5 mm 10 x 5 - 10.2 mm	43802	10
		KEL-DPZ 10 15 with threaded bushings M4	65 x 36 mm	5 x 3.2 - 6.5 mm 10 x 5 - 10.2 mm	43802.400	10
		KEL-DPZ 10 16	65 x 36 mm	9 x 3.2 - 6.5 mm 4 x 5 - 10.2 mm 3 x 7.5 - 12 mm	43803	10
		KEL-DPZ 10 16 with threaded bushings M4	65 x 36 mm	9 x 3.2 - 6.5 mm 4 x 5 - 10.2 mm 3 x 7.5 - 12 mm	43803.400	10
		KEL-DPZ 10 26	65 x 36 mm	26 x 3.2 - 6.5 mm	43804	10
		KEL-DPZ 10 26 with threaded bushings M4	65 x 36 mm	26 x 3.2 - 6.5 mm	43804.400	10

Single-piece packaging units are available on request.



# KEL-DPZ

## Cable entry plates

### KEL-DPZ 6



Description	Cut-out   Drilling template	Type	Cut-out mm	Number of cables	Order No.	PU
		KEL-DPZ 6 12	52 x 36 mm	12 x 4.5 - 8.0 mm	43809	10
		KEL-DPZ 6 18-1	52 x 36 mm	6 x 2.5 - 5.0 mm 5 x 3.2 - 6.5 mm 7 x 4.5 - 8.0 mm	43811	10
		KEL-DPZ 6 18	52 x 36 mm	18 x 3.2 - 6.5 mm	43812	10
		KEL-DPZ 6 23	52 x 36 mm	13 x 2.5 - 5.0 mm 10 x 3.2 - 6.5 mm	43813	10
		KEL-DPZ 6 27	52 x 36 mm	27 x 2.5 - 5.0 mm	43814	10



- 2
- 2.1
- 2.2
- 2.3
- 2.4
- 2.5
- 2.6
- 2.7
- 2.8

# KEL-DPZ

## Cable entry plates

### KEL-DPZ-B



Description	Cut-out   Drilling template	Type	Cut-out mm	Number of cables	Order No.	PU
		KEL-DPZ-B 13	46 x 46 mm	8× 3.2 - 6.5 mm 4× 5 - 10.2 mm 1× 16 - 22 mm	<span style="background-color: #cccccc;">■</span> 43794 <span style="background-color: #333333;">■</span> 50794	10
		KEL-DPZ-B 13 with threaded bushings M4	46 x 46 mm	8× 3.2 - 6.5 mm 4× 5 - 10.2 mm 1× 16 - 22 mm	<span style="background-color: #cccccc;">■</span> 43794.400 <span style="background-color: #333333;">■</span> 50794.400	10
		KEL-DPZ-B 17	46 x 46 mm	10× 3.2 - 6.5 mm 4× 5 - 10.2 mm 2× 7.5 - 12 mm 1× 9 - 16.2 mm	<span style="background-color: #cccccc;">■</span> 43796 <span style="background-color: #333333;">■</span> 50796	10
		KEL-DPZ-B 17 with threaded bushings M4	46 x 46 mm	10× 3.2 - 6.5 mm 4× 5 - 10.2 mm 2× 7.5 - 12 mm 1× 9 - 16.2 mm	<span style="background-color: #cccccc;">■</span> 43796.400 <span style="background-color: #333333;">■</span> 50796.400	10
		KEL-DPZ-B 25	46 x 46 mm	25× 3.2 - 6.5 mm	<span style="background-color: #cccccc;">■</span> 43798 <span style="background-color: #333333;">■</span> 50798	10
		KEL-DPZ-B 25 with threaded bushings M4	46 x 46 mm	25× 3.2 - 6.5 mm	<span style="background-color: #cccccc;">■</span> 43798.400 <span style="background-color: #333333;">■</span> 50798.400	10



The KEL-DPZ series is also available as a cleanroom version, see from page 428.  
Single-piece packaging units are available on request.

# KEL-DPZ

## Cable entry plates

### KEL-DPZ-E



Description	Cut-out   Drilling template	Type	Cut-out mm	Number of cables	Order No.	PU
		KEL-DPZ-E 112 7	18 x 112 mm	7× 7.5 - 12 mm	■ 43780 ■ 50780	10
		KEL-DPZ-E 112 7 with threaded bushings M4	18 x 112 mm	7× 7.5 - 12 mm	■ 43780.400 ■ 50780.400	10
		KEL-DPZ-E 112 21	18 x 112 mm	21× 3.2 - 6.5 mm	■ 43790 ■ 50790	10
		KEL-DPZ-E 112 21 with threaded bushings M4	18 x 112 mm	21× 3.2 - 6.5 mm	■ 43790.400 ■ 50790.400	10

2  
2.1  
**2.2**  
2.3  
2.4  
2.5  
2.6  
2.7  
2.8

**i** The KEL-DPZ series is also available as a cleanroom version, see from page 428.  
Single-piece packaging units are available on request.

# KEL-DPZ round series

## Cable entry plates with IP66/IP68 rating



KEL-DPZ round cable entry plates are designed to route and seal cables without connectors or fibre optics (from 1.5 mm to 22 mm in diameter) in limited space.

The assembly of the KEL-DPZ round with cables or pneumatic hoses can be done quick and easy. Simply make a small hole in the thin membrane, push the cables through. The KEL-DPZ round provides strain relief and protection IP66/IP68/UL Type 4X.

The round versions of the KEL-DPZ series have a thread to fit in metric cut-outs from M25 to M63. Thus cut-outs for metric cable glands can be used. ST-B Plugs can be used for sealing pierced membranes if cables have been removed.

### Advantages & benefits

- Dual sealing of cables acc. to IP66/IP68/up to UL type 4X
- Quick and easy tool-free assembly
- High cable density
- High strain relief
- Suitable for metric cut-outs
- Polyamide locknuts are included in the shipment
- Hygienic design – free of dirt-collecting recesses
- Available as an FDA compliant version

### Specifications

Material	Thread frame: Polyamide (PA) Sealing plate: Elastomer
Colour	■ grey (similar RAL 7035) ■ black
Flame class	UL 94 V-0, self-extinguishing
IP rating	IP65/IP66/IP67/IP68 (certified acc. to EN 60529)
UL type rating	UL type 12 (acc. to UL 50E) UL type 4X (acc. to UL 50E)
Temperature	-40°C to +100°C (static)
Properties	Halogen-free, silicone-free
Cut-out dim.	Metric sizes
Thread length	14 mm
Plate depth	8 mm

### Accessories

ST-B Plugs	171
FP Flanged plates	320 - 329
MP Module plates	314 - 325
TE-M	334 - 337

**i** This product range is also available as a KEL-DPZ-HD version for the food sector, see pages 428 – 429. The KEL-DPZ round is also available as a cleanroom version, see from page 410. Single-piece packaging units are available on request.

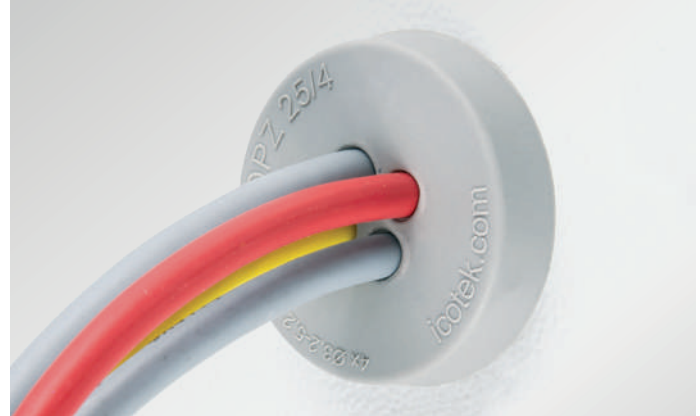

Membrane on front



Conical shape on back provides additional sealing and strain relief



Also available in black



Can be combined with TE-M thread extension



ST-B plug for the sealing of the perforated membrane

# KEL-DPZ round Cable entry plates

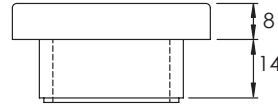
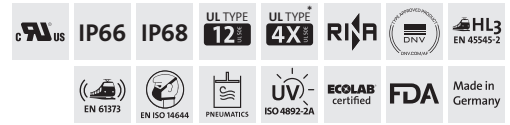

Type	Order No.	Number of cables	Thread metric	Thread length	Max. wall thickness	External diameter	Mounting height	PU
KEL-DPZ 25 3	■ 43736	2× 3.2 - 5.2 mm	M25 × 1.5	14 mm	7.0 mm	39 mm	8 mm	10
	■ 50736	1× 3.2 - 6.5 mm						
KEL-DPZ 25 4	■ 43737	4× 3.2 - 5.2 mm	M25 × 1.5	14 mm	7.0 mm	39 mm	8 mm	10
	■ 50737							
KEL-DPZ 32 4	■ 43732	3× 3.2 - 6.5 mm	M32 × 1.5	14 mm	7.0 mm	44 mm	8 mm	10
	■ 50732	1× 7.2 - 12.5 mm						
KEL-DPZ 32 4-2	■ 43733	4× 5 - 9.5 mm	M32 × 1.5	14 mm	7.0 mm	44 mm	8 mm	10
	■ 50733							
KEL-DPZ 32 7	■ 43734	7× 3.2 - 6.5 mm	M32 × 1.5	14 mm	7.0 mm	44 mm	8 mm	10
	■ 50734							
KEL-DPZ 40 8	■ 43741	4× 3.2 - 6.5 mm	M40 × 1.5	14 mm	7.0 mm	52 mm	8 mm	10
	■ 50741	4× 5 - 10.2 mm						
KEL-DPZ 50 8	■ 43750	5× 5 - 10.2 mm	M50 × 1.5	14 mm	6.0 mm	62 mm	8 mm	10
	■ 50750	3× 7.2 - 12.5 mm						
KEL-DPZ 50 10	■ 43751	7× 3.2 - 6.5 mm	M50 × 1.5	14 mm	6.0 mm	62 mm	8 mm	10
	■ 50751	2× 5 - 10.2 mm 1× 16 - 22.2 mm						
KEL-DPZ 50 12	■ 43752	4× 3.2 - 6.5 mm	M50 × 1.5	14 mm	6.0 mm	62 mm	8 mm	10
	■ 50752	8× 5 - 10.2 mm						
KEL-DPZ 50 19	■ 43758	19× 3.2 - 6.5 mm	M50 × 1.5	14 mm	6.0 mm	62 mm	8 mm	10
	■ 50758							
KEL-DPZ 50 78	■ 43756	76× 1.5 - 2.6 mm	M50 × 1.5	14 mm	6.0 mm	62 mm	8 mm	10
	■ 50756	2× 2.5 - 5 mm						
KEL-DPZ 63 9	■ 43760	1× 3.2 - 6.5 mm	M63 × 1.5	14 mm	6.0 mm	75 mm	8 mm	10
	■ 50760	3× 5 - 10.2 mm 4× 9 - 16.2 mm 1× 16 - 22.2 mm						
KEL-DPZ 63 13	■ 43761	4× 3.2 - 6.5 mm	M63 × 1.5	14 mm	6.0 mm	75 mm	8 mm	10
	■ 50761	4× 5 - 10.2 mm 5× 9 - 16.2 mm						
KEL-DPZ 63 14	■ 43762	14× 5 - 10.2 mm	M63 × 1.5	14 mm	6.0 mm	75 mm	8 mm	10
	■ 50762							
KEL-DPZ 63 35	■ 43763	35× 3.2 - 6.5 mm	M63 × 1.5	14 mm	6.0 mm	75 mm	8 mm	10
	■ 50763							

2  
2.1  
2.2  
2.3  
2.4  
2.5  
2.6  
2.7  
2.8

## KEL-DPZ-CLICK series

Cable entry plates  
for snap-in or screw-in assembly  
with IP65/IP66/IP68 rating

IP65 IP66 IP68

The round cable entry plates KEL-DPZ-CLICK are designed to route and seal cables without connectors or fibre optics (from 1.5 mm to 22 mm in diameter) in limited space.

The variant of the proven cable entry plate KEL-DPZ is snapped into the cut-out directly from the front. This significantly reduces the assembly time. Alternatively, the new variant can be fastened with a lock nut to achieve protection class IP66/IP68. The KEL-DPZ-CLICK series have a thread to fit in metric cut-outs from M25 to M63. Thus cut-outs for metric cable glands can be used. A lock nut is not included in the shipment.

### Snap-in assembly:

For wall thickness 1 – 2.5 mm  
Protection class IP65

### Screwed in place with a lock nut:

For max. wall thickness 11 mm  
Protection class IP66/IP68

### Advantages & benefits

- Easy assembly directly from the front
- Offers two mounting types:
  - Snap in (IP65) and Screw in (up to IP68)
- Certified protection IP65/IP66/IP68 (acc. to EN 60529)
- High cable density
- Automatic sealing and strain relief for the cable
- Suitable for metric cut-outs M25 – M63
- Snap-in assembly: For wall thickness 1.0 – 2.5 mm
- Screw assembly: For wall thickness up to 11 mm

### Specifications

Material	Polyamid, Elastomere
IP rating	Snap-in: IP65 Screwed in place with lock nut: IP65/IP66/IP68
Flame class	UL 94 V-0, self-extinguishing
Temperature	-40°C to +100°C (static)
Colour	■ grey (similar to RAL 7035)
Properties	Halogen free, silicone free
Mounting height	8 mm

### Accessories

KGM locknuts	346
TE-M	334 - 337



**Mounting type 1:**  
Snap into the cut-out  
For wall thickness 1 – 2.5 mm

**Mounting type 2:**  
Screwed in place with a lock nut  
For max. wall thickness 11 mm

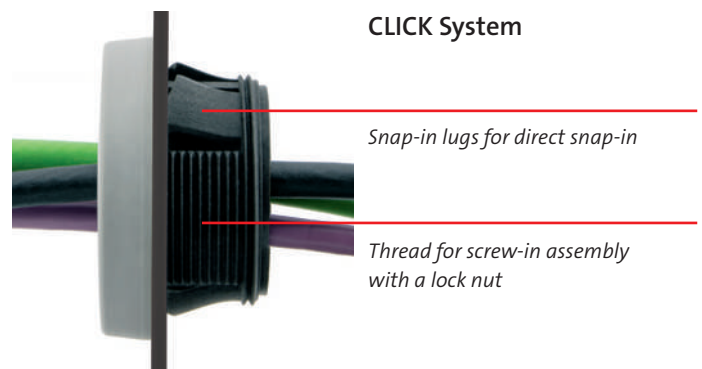
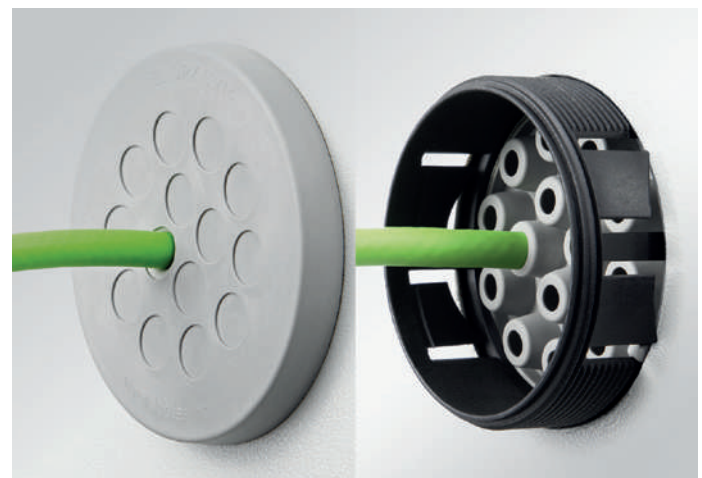

**i** Single-piece packaging units are available on request.

# KEL-DPZ-CLICK

## Cable entry plates

### for snap-in or screw-in assembly

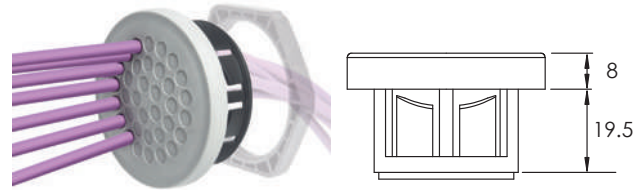

Type	Order No.	Number of cables	Thread metric	Thread length	External diameter	Mounting height	PU
KEL-DPZ-CLICK 25 3	44050	2× 3.2 – 5.2 mm 1× 3.2 – 6.5 mm	M25 × 1.5	19.5 mm	39 mm	8 mm	10
KEL-DPZ-CLICK 25 4	44051	4× 3.2 – 5.2 mm	M25 × 1.5	19.5 mm	39 mm	8 mm	10
KEL-DPZ-CLICK 32 4	44052	3× 3.2 – 6.5 mm 1× 7.2 – 12.5 mm	M32 × 1.5	19.5 mm	44 mm	8 mm	10
KEL-DPZ-CLICK 32 4-2	44053	4× 5 – 9.5 mm	M32 × 1.5	19.5 mm	44 mm	8 mm	10
KEL-DPZ-CLICK 32 7	44054	7× 3.2 – 6.5 mm	M32 × 1.5	19.5 mm	44 mm	8 mm	10
KEL-DPZ-CLICK 40 8	44055	4× 3.2 – 6.5 mm 4× 5 – 10.2 mm	M40 × 1.5	19.5 mm	52 mm	8 mm	10
KEL-DPZ-CLICK 50 8	44056	5× 5 – 10.2 mm 3× 7.2 – 12.5 mm	M50 × 1.5	19.5 mm	62 mm	8 mm	10
KEL-DPZ-CLICK 50 10	44057	7× 3.2 – 6.5 mm 2× 5 – 10.2 mm 1× 16 – 22.2 mm	M50 × 1.5	19.5 mm	62 mm	8 mm	10
KEL-DPZ-CLICK 50 12	44058	4× 3.2 – 6.5 mm 8× 5 – 10.2 mm	M50 × 1.5	19.5 mm	62 mm	8 mm	10
KEL-DPZ-CLICK 50 19	44059	19× 3.2 – 6.5 mm	M50 × 1.5	19.5 mm	62 mm	8 mm	10
KEL-DPZ-CLICK 50 78	44060	76× 1.5 – 2.6 mm 2× 2.5 – 5 mm	M50 × 1.5	19.5 mm	62 mm	8 mm	10
KEL-DPZ-CLICK 63 9	44061	1× 3.2 – 6.5 mm 3× 5 – 10.2 mm 4× 9 – 16.2 mm 1× 16 – 22.2 mm	M63 × 1.5	19.5 mm	75 mm	8 mm	10
KEL-DPZ-CLICK 63 13	44062	4× 3.2 – 6.5 mm 4× 5 – 10.2 mm 5× 9 – 16.2 mm	M63 × 1.5	19.5 mm	75 mm	8 mm	10
KEL-DPZ-CLICK 63 14	44063	14× 5 – 10.2 mm	M63 × 1.5	19.5 mm	75 mm	8 mm	10
KEL-DPZ-CLICK 63 35	44064	35× 3.2 – 6.5 mm	M63 × 1.5	19.5 mm	75 mm	8 mm	10

2  
2.1  
2.2  
2.3  
2.4  
2.5  
2.6  
2.7  
2.8

## KEL-DPR

Cable entry plates for screw-in assembly,  
with IP65 rating

NEW IP64 IP65

The KEL-DPR 24 cable entry plate is based on the proven KEL-DP 24, but has an integrated polypropylene reinforcement frame. With the KEL-DPR 24, up to 48 cables from 1 to 16.1 mm can be inserted in the smallest of spaces and sealed in accordance with IP65.

The KEL-DPR 24 cable entry fits standard cut-outs for 24-pin heavy-duty connectors.

Electrical and pneumatic lines can be assembled in a matter of seconds. The corresponding membrane is perforated and the cables are simply pushed through. Perforated membranes can be sealed with ST-B plugs.

The KEL-DPR is available in the colour black. A version with M4 threaded bushings is optionally available for screw assembly from the rear.

### Advantages

- Good strain relief due to reinforced membrane
- Sealing in accordance with IP65
- Very quick installation
- Very high packing density
- Suitable for standardised cut-outs
- Optionally available with M4 threaded bushes
- Visually attractive design

### Specifications

Material	Frame: Polypropylene (PP) Membrane: Elastomer
Colour	■ black
Flame class	UL 94 V-0, self-extinguishing
IP rating	IP64/IP65 (certified acc. to EN 60529-2000-09)
Temperature	-40°C to +90°C (static)
Properties	Halogen free, silicone free
Mounting height	10 mm

### Accessories

ST-B Plugs	171
KEA	340 - 343



Reverse



# KEL-DPR

## Cable entry plates for screw-in assembly



Description	Cut-out   Drilling template	Type	Cut-out mm	Number of cables	Order No.	PU
		KEL-DPR 24 12	112 x 36 mm	12× max. 15 mm	46500	10
		KEL-DPR 24 17	112 x 36 mm	5× max. 10,5 mm 12× max. 12,6 mm	46501	10
		KEL-DPR 24 25	112 x 36 mm	18× max. 6,5 mm 7× max. 12,1 mm	46502	10
		KEL-DPR 24 26	112 x 36 mm	16× max. 6,5 mm 4× max. 12,1 mm 4× max. 16,1 mm 2× ASI cable	46503	10
		KEL-DPR 24 48	112 x 36 mm	48× max. 6,5 mm	46504	10



Also available with threaded bushings

- 2
- 2.1
- 2.2
- 2.3
- 2.4
- 2.5
- 2.6
- 2.7
- 2.8

# KEL-DP series

## Cable entry plates with IP64 rating



KEL-DP entry plates are designed for routing cables without connectors, hoses or fibre optics in limited space.

The KEL-DP products are an easy to assemble and cost saving alternative to traditional cable glands. Simply make a small hole in the thin membrane and push the cables through. The KEL-DP provides protection IP64/UL type 12.

The KEL-DP matches exactly the cut-out dimensions of 6-, 10-, 16- and 24-pin standard industrial connectors. The very compact size KEL-DP-E is designed for routing cables in very small space. Through a cut-out of only 18 × 112 mm, up to 21 cables can be easily routed and sealed. A special rib ensures a centred fit in the cut-outs. ST-B Plugs can be used for sealing pierced membranes if cables have been removed.

### Advantages & benefits

- Fast and easy assembly, no tools required
- Very good strain relief on the cable bundle
- Very high cable density
- Cost-effective
- Hygienic design – free of dirt-collecting recesses
- For wall thickness 1.5 - 4 mm

### Specifications

Material	Elastomer
Colour	■ grey (similar RAL 7035) ■ black
Flame class	UL 94 V-0, self-extinguishing
IP rating	IP64 (certified acc. to EN 60529)
UL type rating	UL type 12 (acc. to UL 50E)
Temperature	-40°C to +100°C (static)
Properties	Halogen-free, silicone-free
Plate depth	5 mm
Type A:	For wall thickness 1.5 - 2.5 mm
Type B:	For wall thickness 2.8 - 4 mm

### Accessories

ST-B Plugs	171
FP Flanged plates	320 - 329
KEA Cable Entry Adapter	340 - 343

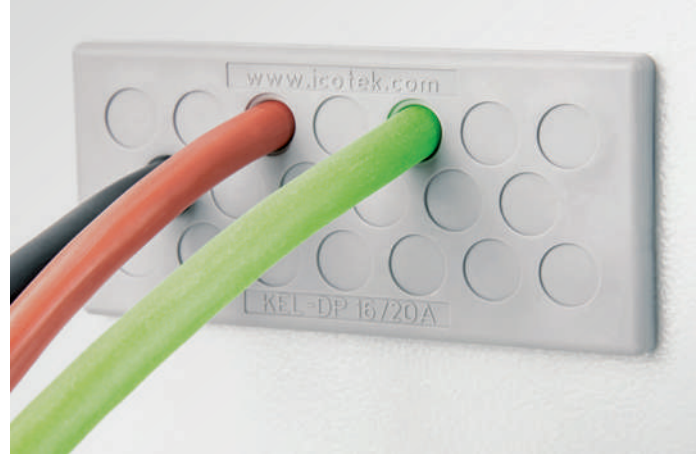

Fastening

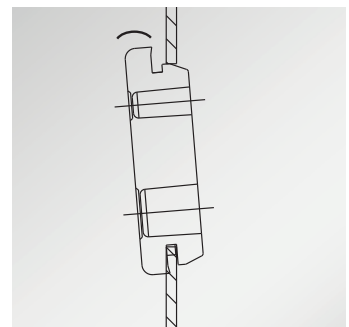

Also available in black



Can be combined with 90° cable entry adapter KEA

 Single-piece packaging units are available on request.

# KEL-DP

## Cable entry plates

### KEL-DP 24



Description	Cut-out	Type	Cut-out mm	Number of cables	Order No. Type A	Order No. Type B	PU
		KEL-DP 24 12	112 x 36 mm	12× max. 15 mm	■ 43508 ■ 50508	■ 43510 ■ 50510	10
		KEL-DP 24 14	112 x 36 mm	14× max. 12.1 mm	■ 43512 ■ 50512	■ 43522 ■ 50522	10
		KEL-DP 24 17	112 x 36 mm	5× max. 10.5 mm 12× max. 12.6 mm	■ 43514 ■ 50514	■ 43523 ■ 50523	10
		KEL-DP 24 18	112 x 36 mm	4× max. 6.5 mm 5× max. 10.5 mm 5× max. 12.6 mm 4× max. 16.1 mm	■ 43515 ■ 50515	■ 43528 ■ 50528	10
		KEL-DP 24 19	112 x 36 mm	12× max. 6.5 mm 7× max. 12.1 mm	■ 43516 ■ 50516	■ 43524 ■ 50524	10
		KEL-DP 24 26	112 x 36 mm	16× max. 6.5 mm 4× max. 12.1 mm 4× max. 16.1 mm 2× ASI cables	■ 43518 ■ 50518	■ 43525 ■ 50525	10
		KEL-DP 24 42	112 x 36 mm	1× max. 4.7 mm 12× max. 5 mm 17× max. 6.4 mm 12× max. 7.2 mm	■ 43511 ■ 50511	■ 43521 ■ 50521	10
		KEL-DP 24 48	112 x 36 mm	48× max. 6.5 mm	■ 43519 ■ 50519	■ 43526 ■ 50526	10
		KEL-DP 24 50	112 x 36 mm	33× max. 5.3 mm 9× max. 6.4 mm 8× max. 8.3 mm	■ 43520 ■ 50520	■ 43527 ■ 50527	10

2  
2.1  
2.2  
2.3  
2.4  
2.5  
2.6  
2.7  
2.8

# KEL-DP

## Cable entry plates

### KEL-DP 16



Description	Cut-out	Type	Cut-out mm	Number of cables	Art.-Nr.	PU
		KEL-DP 16 10	86 x 36 mm	10 x max. 12.1mm	43460	10
		KEL-DP 16 11	86 x 36 mm	3 x max. 10.5 mm 8 x max. 12.6 mm	43461	10
		KEL-DP 16 20	86 x 36 mm	20 x max. 8.3 mm	43462	10
		KEL-DP 16 22	86 x 36 mm	13 x max. 6.5 mm 4 x max. 8.3 mm 5 x max. 12.1 mm	43463	10
		KEL-DP 16 23	86 x 36 mm	18 x max. 6.5 mm 5 x max. 12.1 mm	43464	10
		KEL-DP 16 26	86 x 36 mm	19 x max. 6.5 mm 7 x max. 8.3 mm	43465	10

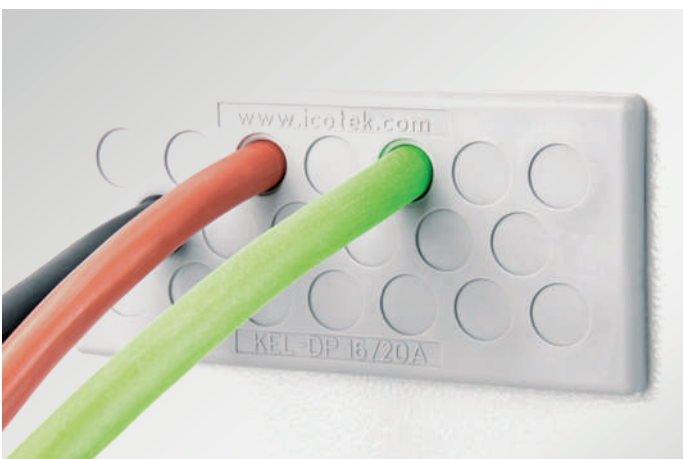

KEL-DP 16

**i** Single-piece packaging units are available on request.

# KEL-DP

## Cable entry plates

### KEL-DP 10

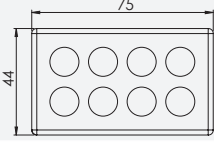
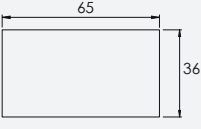
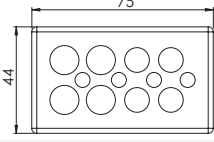
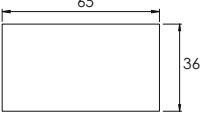
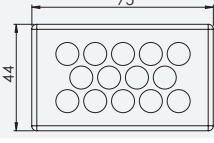
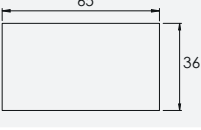
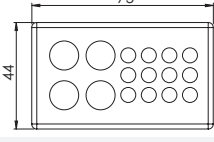
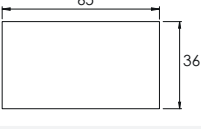
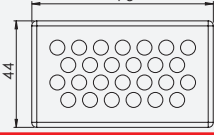
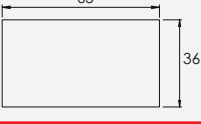

Description	Cut-out	Type	Cut-out mm	Number of cables	Art.-Nr.	PU
		KEL-DP 10 8	65 x 36 mm	8 x max. 12.6 mm	43466	10
		KEL-DP 10 12	65 x 36 mm	4 x max. 6.5 mm 4 x max. 8.3 mm 4 x max. 12.6 mm	43467	10
		KEL-DP 10 14	65 x 36 mm	14 x max. 8.3 mm	43468	10
		KEL-DP 10 16	65 x 36 mm	12 x max. 6.5 mm 4 x max. 12.6 mm	43469	10
		KEL-DP 10 26	65 x 36 mm	26 x max. 6.5 mm	43470	10

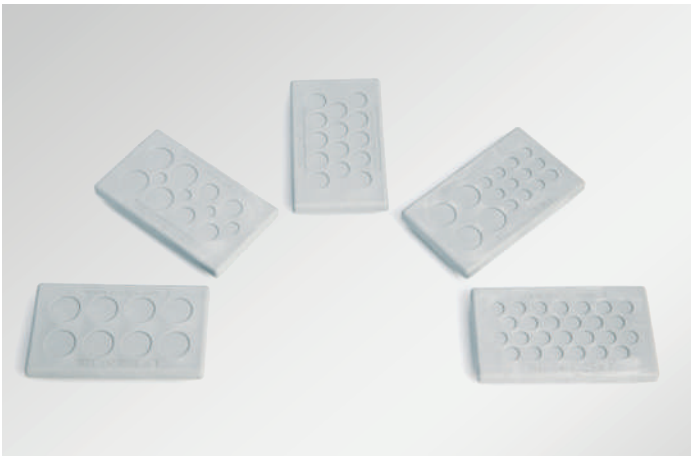

- 2
- 2.1
- 2.2
- 2.3
- 2.4
- 2.5
- 2.6
- 2.7
- 2.8

KEL-DP 10

# KEL-DP

## Cable entry plates

### KEL-DP 6

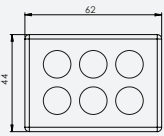
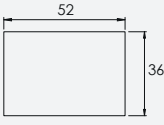
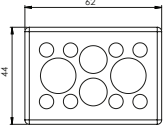
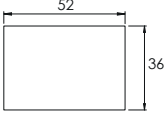
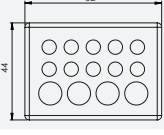
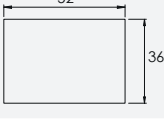
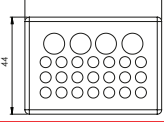
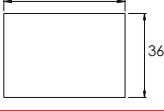

Description	Cut-out	Type	Cut-out mm	Number of cables	Art.-Nr.	PU
		KEL-DP 6 6	52 x 36 mm	6 x max. 12.1 mm	43450	10
		KEL-DP 6 12	52 x 36 mm	8 x max. 6.5 mm 2 x max. 12.6 mm 2 x max. 16.1 mm	43451	10
		KEL-DP 6 14	52 x 36 mm	10 x max. 6.5 mm 4 x max. 10.5 mm	43452	10
		KEL-DP 6 25	52 x 36 mm	21 x max. 5.0 mm 4 x max. 8.3 mm	43453	10

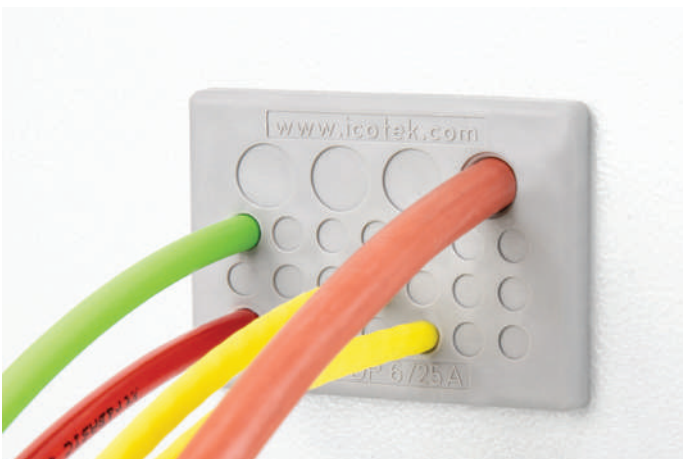

KEL-DP 6

**i** Single-piece packaging units are available on request.

# KEL-DP

## Cable entry plates

### KEL-DP-E



Description	Cut-out	Type	Cut-out mm	Number of cables	Art.-Nr.	PU
		KEL-DP-E 46 7	46 × 18 mm	2× max. 6.5 mm 5× max. 8.3 mm	■ 43585 ■ 50585	10
		KEL-DP-E 46 9	46 × 18 mm	8× max. 6.5 mm 1× max. 12.1 mm	■ 43587 ■ 50587	10
		KEL-DP-E 86 13	85 × 18 mm	2× max. 6.5 mm 11× max. 8.3 mm	■ 43581 ■ 50581	10
		KEL-DP-E 86 17	85 × 18 mm	16× max. 6.5 mm 1× max. 12.1 mm	■ 43583 ■ 50583	10
		KEL-DP-E 112 16	112 × 18 mm	4× max. 6.5 mm 11× max. 8.3 mm 1× max. 12.1 mm	■ 43576 ■ 50576	10
		KEL-DP-E 112 21	112 × 18 mm	16× max. 6.5 mm 4× max. 8.3 mm 1× max. 12.1 mm	■ 43578 ■ 50578	10
		KEL-DP-S 69 8	69 × 10 mm Edge radii R2	8× max. 7.5 mm	■ 43591 ■ 50591	10

- 2
- 2.1
- 2.2
- 2.3
- 2.4
- 2.5
- 2.6
- 2.7
- 2.8

Single-piece packaging units are available on request.

# KEL-DP round

## Cable entry plates with IP65 rating



KEL-DP entry plates are designed for routing cables without connectors, hoses or fibre optics in limited space.

The KEL-DP products are an easy to assemble and cost saving alternative to traditional cable glands. Simply make a small hole in the thin membrane and push the cables through. The KEL-DP round provides protection IP65/UL type 12.

The round version of the KEL-DP fits perfectly into metric cut-outs M16 to M50. A special rib ensures a centred fit in the cut-outs.

ST-B Plugs can be used for sealing pierced membranes if cables have been removed.

### Advantages & benefits

- Fast and easy assembly, no tools required
- High cable density
- Very good strain relief on the cable bundle
- Cost-effective
- For wall thickness 1.5 – 4 mm

### Specifications

Material	Elastomer
Colour	■ grey (similar RAL 7035) ■ black
Flame class	UL 94 V-0, self-extinguishing
IP rating	IP65 (certified acc. to EN 60529)
UL type rating	UL type 12 (acc. to UL 50E)
Temperature	-40°C to +100°C (static)
Properties	Halogen-free, silicone-free
Cut-out dimensions	Metric sizes
Plate depth	5 mm

Type A:	For wall thickness 1.5 – 2.5 mm
Type B:	For wall thickness 2.8 – 4 mm

### Accessories

ST-B Plugs	171
FP Flange plates	320 - 329

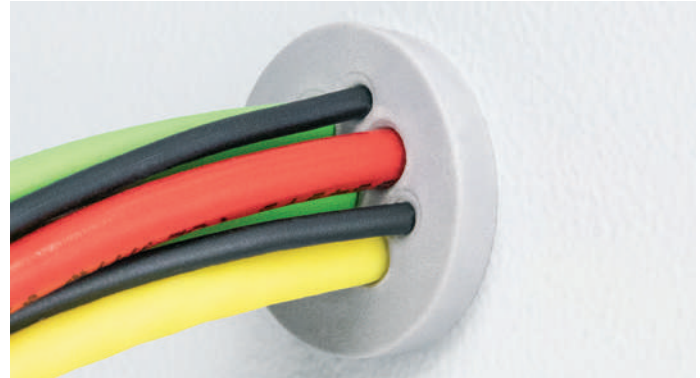

Also available in black



Membrane on front

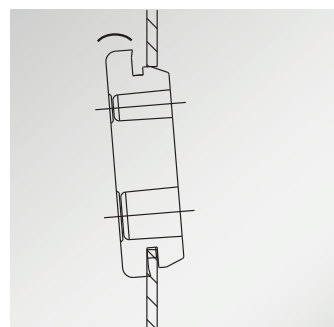

Fastening



Special fixing ribs ensure a centred fit

**i** Single-piece packaging units are available on request.



# KEL-DP round

## Cable entry plates with IP65 rating

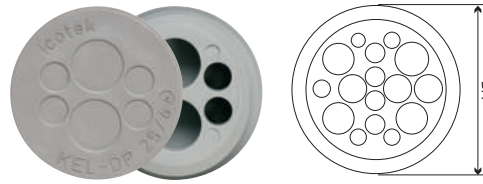

Type	Order No. Typ A	Order No. Typ B	Number of cables	Cut-out	External diameter DA	PU
KEL-DP 16 1 rund	■ 43600 ■ 50535	–	1× max. 9,2 mm	∅ 16 mm	23 mm	10
KEL-DP 16 3 rund	■ 43601	–	3× max. 5,2 mm	∅ 16 mm	23 mm	10
KEL-DP 16 7 rund	■ 43602	–	7× max. 3,2 mm	∅ 16 mm	23 mm	10
KEL-DP 20 1	■ 43571	–	1× max. 14 mm	∅ 20 mm	27 mm	10
KEL-DP 20 4	■ 43572	–	4× max. 5.2 mm	∅ 20 mm	27 mm	10
KEL-DP 20 4-1	■ 43575	–	2× max. 4.5 2× max. 8.0	∅ 20 mm	27 mm	10
KEL-DP 20 5	■ 43573	–	2× max. 3.6 mm 2× max. 4.6 mm 1× max. 10.6 mm	∅ 20 mm	27 mm	10
KEL-DP 20 9	■ 43574	–	4× max. 3.6 mm 5× max. 4.6 mm	∅ 20 mm	27 mm	10
KEL-DP 25 4	■ 43533 ■ 50533	■ 50536 ■ 43535	4× max. 8 mm	∅ 25 mm	32 mm	10
KEL-DP 25 6	■ 43531 ■ 50531	–	4× max. 5.2 mm 2× max. 9.4 mm	∅ 25 mm	32 mm	10
KEL-DP 25 7	■ 43534	–	7× max. 5.2 mm	∅ 25 mm	32 mm	10
KEL-DP 32 7	■ 43592	■ 43596	7× max. 8.0 mm	∅ 32 mm	38 mm	10
KEL-DP 32 10	■ 43532 ■ 50532	■ 43560 ■ 50560	6× max. 5.2 mm 2× max. 6.4 mm 2× max. 9.4 mm	∅ 32 mm	38 mm	10
KEL-DP 32 10-2	■ 43593	■ 43597	10× max. 6.4 mm	∅ 32 mm	38 mm	10
KEL-DP 32 11	■ 43594	■ 43598	9× max. 5.2 mm 2× max. 8.0 mm	∅ 32 mm	38 mm	10
KEL-DP 32 13	■ 43595	■ 43599	13× max. 5.2 mm	∅ 32 mm	38 mm	10

2  
2.1  
2.2  
2.3  
2.4  
2.5  
2.6  
2.7  
2.8

# KEL-DP round

## Cable entry plates with IP65 rating



Type	Order No. Type A	Order No. Type B	Number of cables	Cut-out	External diameter DA	PU
KEL-DP 40 9	■ 43536	■ 43561	8× max. 9.5 mm 1× max. 11.3 mm	∅ 40 mm	50 mm	10
KEL-DP 40 16	■ 43537	■ 43563	2× max. 5.3 mm 10× max. 6.3 mm 2× max. 9.5 mm 2× max. 11.3 mm	∅ 40 mm	50 mm	10
KEL-DP 40 17	■ 43538	■ 43565	1× max. 4 mm 16× max. 7.2 mm	∅ 40 mm	50 mm	10
KEL-DP 50 9	■ 43554 ■ 50554	■ 43568 ■ 50568	5× max. 7 mm 4× max. 18 mm	∅ 50 mm	60 mm	10
KEL-DP 50 11	■ 43555 ■ 50555	■ 43569 ■ 50569	7× max. 7.2 mm 3× max. 11.2 mm 1× max. 22.5 mm	∅ 50 mm	60 mm	10
KEL-DP 50 12	■ 43551 ■ 50551	■ 43562 ■ 50562	10× max. 9.2 mm 2× max. 11.2 mm	∅ 50 mm	60 mm	10
KEL-DP 50 16	■ 43550 ■ 50550	■ 43564 ■ 50564	4× max. 5.3 mm 5× max. 6.3 mm 3× max. 9.5 mm 4× max. 11.3 mm	∅ 50 mm	60 mm	10
KEL-DP 50 18	■ 43553 ■ 50553	■ 43567 ■ 50567	2× max. 4 mm 2× max. 6 mm 4× max. 7.2 mm 5× max. 9.4 mm 5× max. 12 mm	∅ 50 mm	60 mm	10
KEL-DP 50 20	■ 43552 ■ 50552	■ 43566 ■ 50566	16× max. 6.3 mm 4× max. 9.3 mm	∅ 50 mm	60 mm	10
KEL-DP 50 35	■ 43556 ■ 50556	■ 43570 ■ 50570	35× max. 5.2 mm	∅ 50 mm	60 mm	10



Single-piece packaging units are available on request.

# ST-B

## Plugs for membranes and multi-range cable grommets



The ST-B plugs are used to seal perforated membranes of the cable entry plates (KEL-DPU, KEL-DPZ, KEL-DP, KEL-QTA), DT grommets and, in particular, the KTMB and QTMB multi-range cable grommets. This means that entries that are no longer required can be closed. The protection rating of the cable entry remains unchanged.

The new generation of ST-B plugs has a uniform length of 30 mm to prevent the plugs from slipping out.

### Advantages & benefits

- Sealing of perforated cable entry membranes which are no longer in use
- For sealing unused cable grommets

### Specifications

Material	Polyamide (PA), white
Flame class	UL 94 V-0, self-extinguishing
Temperature	-40°C to +120°C
Properties	Halogen-free, silicone-free

### Compatible with

KEL-DPU Cable entry plates	144 - 147
KEL-DPZ Cable entry plates	148 - 155
KEL-DP Cable entry plates	162 - 167
KT-DT Cable entry grommets	84
KEL-QTA Cable entry plates	112 - 115
KTMB multi-range cable grommets	78 - 79
QTMB multi-range cable grommets	119

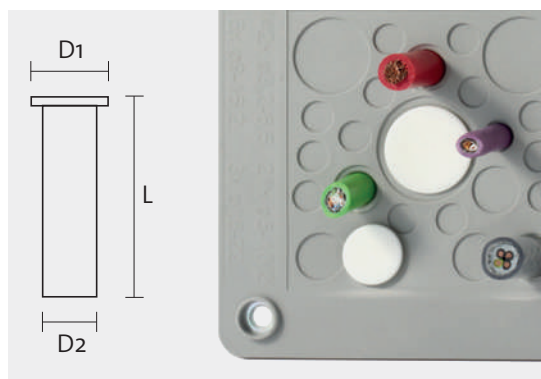

Type	Order No.	Diameter D1	Diameter D2	Length L	PU
ST-B 5 30	42805	8 mm	5 mm	30 mm	25
ST-B 6 30	42806	9 mm	6 mm	30 mm	25
ST-B 7 30	42807	10 mm	7 mm	30 mm	25
ST-B 8 30	42808	11 mm	8 mm	30 mm	25
ST-B 9 30	42809	12 mm	9 mm	30 mm	25
ST-B 10 30	42810	13 mm	10 mm	30 mm	25
ST-B 11 30	42811	14 mm	11 mm	30 mm	25
ST-B 12 30	42812	15 mm	12 mm	30 mm	25
ST-B 13 30	42813	16 mm	13 mm	30 mm	25
ST-B 14 30	42814	17 mm	14 mm	30 mm	25
ST-B 15 30	42815	18 mm	15 mm	30 mm	25
ST-B 16 30	42816	19 mm	16 mm	30 mm	25
ST-B 17 30	42817	20 mm	17 mm	30 mm	25
ST-B 18 30	42818	21 mm	18 mm	30 mm	25
ST-B 19 30	42819	22 mm	19 mm	30 mm	25
ST-B 20 30	42820	23 mm	20 mm	30 mm	10
ST-B 21 30	42821	24 mm	21 mm	30 mm	10
ST-B 22 30	42822	25 mm	22 mm	30 mm	10
ST-B 23 30	42823	26 mm	23 mm	30 mm	10
ST-B 24 30	42824	27 mm	24 mm	30 mm	10
ST-B 25 30	42825	28 mm	25 mm	30 mm	10
ST-B 26 30	42826	29 mm	26 mm	30 mm	10
ST-B 27 30	42827	30 mm	27 mm	30 mm	10
ST-B 28 30	42828	31 mm	28 mm	30 mm	10
ST-B 29 30	42829	32 mm	29 mm	30 mm	10
ST-B 30 30	42830	33 mm	30 mm	30 mm	10
ST-B 31 30	42831	34 mm	31 mm	30 mm	10
ST-B 32 30	42832	35 mm	32 mm	30 mm	10
ST-B 33 30	42833	36 mm	33 mm	30 mm	10
ST-B 34 30	42834	37 mm	34 mm	30 mm	10

2  
2.1  
2.2  
2.3  
2.4  
2.5  
2.6  
2.7  
2.8

# KEL-DPZ-KX/KL

## Cable entry plates for enclosures



The KEL-DPZ-KX/KL cable entry plates allow a large number of cables to be routed in a very small space and sealed twice in accordance with IP65/IP66/UL Type 12. At the same time, the cables are strain-relieved.

The KEL-DPZ-KX/KL was specially developed for Rittal KL and KX terminal boxes. Up to 72 cables can be routed with this size. The self-tapping screws (M4, thread-forming) required for installation are included in the scope of delivery.

Electrical and pneumatic lines can be assembled in a matter of seconds. The corresponding membrane is perforated and the cables are simply pushed through. Perforated membranes can be sealed with ST-B plugs.

### Advantages

- Dual cable sealing acc. to IP65/IP66
- Fast and easy assembly
- High cable density
- High strain relief

### Specifications

Material	Frame: Stainless steel V2A Membrane: Elastomer
Colour	■ grey (similar RAL 7035) ■ black (KEL-DPZ-KX/KL 72 only)
Flame class	UL 94 V-0, self-extinguishing
IP rating	IP65 (certified acc. to EN 60529:2000-09)
Temperature	-40°C to +140°C (static)
Properties	Halogen-free, silicone-free
Mounting height	14 mm

### Accessories

ST-B plugs	171
FP-KX/KL	324 - 325

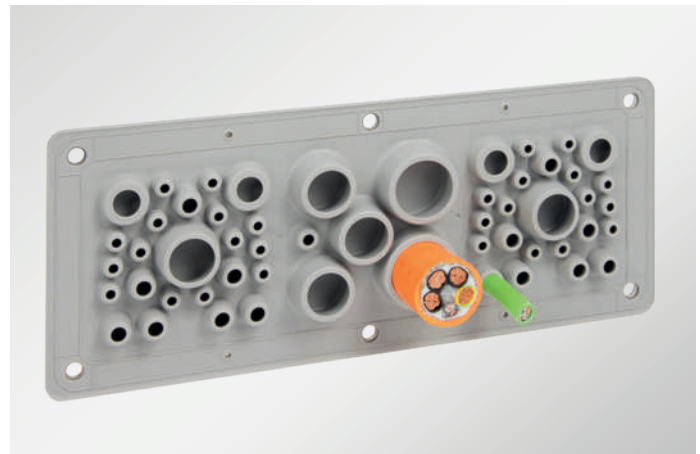

ST-B plug for the sealing of the perforated membrane

**i** The KEL-DPZ series is also available as a cleanroom version, see from page 409. Single-piece packaging units are available on request.

# KEL-DPZ-KX/KL

## Cable entry plates for enclosures

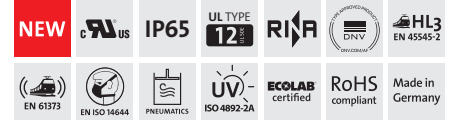

Description	Type	Cut-out mm	Number of cables	Order No.	PU
	<b>NEW</b> KEL-DPZ-KX/KL 24	62 x 192 mm	1× 4 - 7.5 mm 18× 10 - 17 mm 3× 15 - 20 mm 2× 21 - 26 mm	43682	1
	<b>NEW</b> KEL-DPZ-KX/KL 39	62 x 192 mm	14× 3.2 - 6.5 mm 1× 4 - 7.5 mm 7× 5 - 10.2 mm 2× 9 - 16.2 mm 9× 10 - 17 mm 3× 15 - 20 mm 1× 16 - 22 mm 2× 21 - 26 mm	43684	1
	<b>NEW</b> KEL-DPZ-KX/KL 42	62 x 192 mm	14× 3.2 - 6.5 mm 7× 5 - 10.2 mm 2× 9 - 16.2 mm 18× 10 - 17 mm 1× 16 - 22 mm	43686	1
	<b>NEW</b> KEL-DPZ-KX/KL 54	62 x 192 mm	28× 3.2 - 6.5 mm 1× 4 - 7.5 mm 14× 5 - 10.2 mm 4× 9 - 16.2 mm 2× 15 - 20 mm 2× 16 - 22 mm 2× 21 - 26 mm	43683	1
	<b>NEW</b> KEL-DPZ-KX/KL 57	62 x 192 mm	28× 3.2 - 6.5 mm 14× 5 - 10.2 mm 4× 9 - 16.2 mm 9× 10 - 17 mm 2× 16 - 22 mm	43685	1
	KEL-DPZ-KX/KL 72	62 x 192 mm	42× 3.2 - 6.5 mm 21× 5 - 10.2 mm 6× 9 - 16.2 mm 3× 16 - 22 mm	43675.001 43675.101	1

2  
2.1  
2.2  
2.3  
2.4  
2.5  
2.6  
2.7  
2.8

# Cover plugs for cable entry plates

The openings at the fastening points of the cable entry plates can be closed with the cover plugs.

The cover plugs can be used with the products of the KEL-DPZ series. They are available in black and grey.

## Advantages & benefits

- Simple closing of the openings at the fastening points of the KEL-DPZ
- Smooth finish on the frame surface
- No dirt recesses

## Specifications

Material	PE (Polyethylen)
Temperature	Continuous operating temperature +70°C
Properties	Higher chemical resistance

Description	Order No.	PU
Cover plugs <b>B</b> black for M5 DIN 912 Screws, for KEL-DPZ	■ 99200	40
Cover plugs <b>C</b> grey for M5 DIN 912 Screws, for KEL-DPZ	■ 99201	40

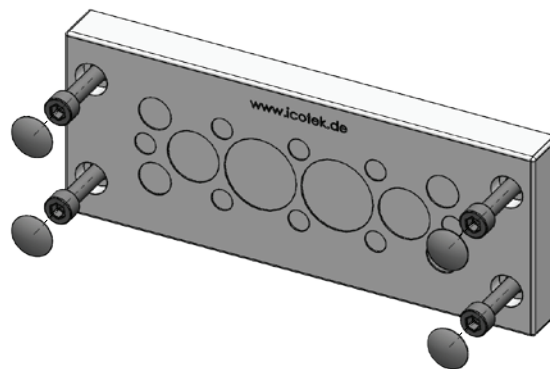

When fastening from the front by means of screws, the openings at the screw heads can be closed with the **cover plugs B** in black (order no. 99200) or **cover plugs C** in grey (order no. 99201). The cover plugs can only be used for M5 DIN 912 screws.



Having trouble finding a solution?  
icotek can develop a solution for  
your individual needs.

Contact us: [pm@icotek.com](mailto:pm@icotek.com)

Made in  
Germany

Free  
product samples

Customer  
service

No minimum  
order value

Custom  
projects

Global  
shipping

Certified  
products

2  
2.1  
2.2  
2.3  
2.4  
2.5  
**2.6**  
2.7  
2.8

## 2.7 – 2.8 Flexible cable entry grommets for cables without connectors



Fast and easy, partially tool-free assembly



High flexibility when routing rigid cables



KEL-SCDP-TR

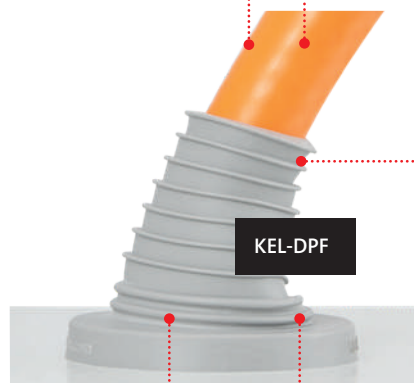

KEL-DPF

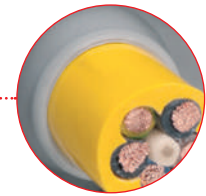

Up to IP66/IP68 rated protection



Easy peeling of the membrane rings. The peeled-off area is always round and thus seals the cable very well.



Due to high elasticity also suitable for routing preassembled cable lugs/terminals.

Compact, space-saving design

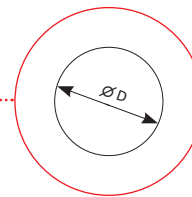

For metric cut-outs M25 – M85 (KEL-DPF)

- 2
- 2.1
- 2.2
- 2.3
- 2.4
- 2.5
- 2.6
- 2.7
- 2.8





IP65

**Cable entry plates**  
for screw-in assembly, M25 – M63,  
for cable diameters up to 36 mm

KEL-SCDP-TR

178 – 179



IP65

**Cable entry plates**  
for plug-in assembly, M25 – M85,  
for cable diameters up to 36 mm

KEL-SCDP / KEL-SCDP-RW

180 – 181



IP66

IP68

**Cable entry grommets**  
for screw-in assembly, M25 – M85,  
for cable diameters up to 70 mm

KEL-DPF

182 – 183

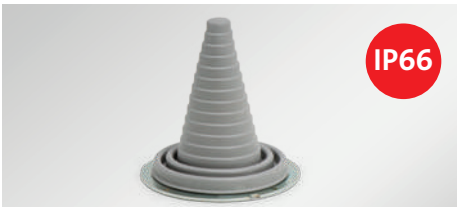

IP66

**Cable entry grommets**  
for screw-in assembly,  
for cable diameters up to 115 mm

KEL-ULTRA flex

184

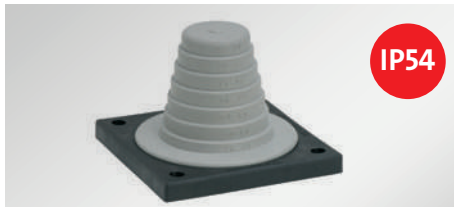

IP54

**Cable entry grommets**  
for screw-in assembly,  
for cable diameters up to 68 mm

KEL-JUMBO flex

185



**Thread extension**  
for cable glands and cable entry plates  
M32, M50, M63

TE-M

334 – 337



IP54

Rittal/Lohmeier  
**Module plates**  
for cable entry components

MP

314 – 315

2  
2.1  
2.2  
2.3  
2.4  
2.5  
2.6  
2.7  
2.8

# KEL-SCDP-TR

## Cable entry plate for screw-in assembly with IP65 rating



With the KEL-SCDP-TR cable entry grommet, single cables, hoses, and conduits can be routed and sealed at a rating of IP65. The KEL-SCDP-TR 63|5+1 enables the routing of up to five cables at the same time.

Its unique advantage is the large sealing range. The single circular membrane can be peeled away to accommodate the specific diameter of the cable or hose. For this purpose, only a small hole between the rings needs to be pierced. Then the corresponding ring can be removed. No tooling is required to peel off the membrane. The peeled-off area is always round, ensuring a secure seal around the cable or the hose.

Due to its high elasticity, the KEL-SCDP-TR is also suitable for routing pre-assembled cable lugs.

The KEL-SCDP-TR plates have a thread to fit in metric cut-outs from M25 to M63. Thus cut-outs for metric cable glands can be used.

The KEL-SCDP-TR is screwed in place with a locknut. A matching locknut is included in the delivery.

### Advantages & benefits

- Fast and secure assembly with the use of included locknut
- Very large sealing range (5 – 52 mm)
- Flexible even with rigid cables
- Metric thread (M25 – M63), suitable for metric cut-outs
- Perfect edge protection and sealing
- Circular membranes can be peeled off easily
- Locknut is included in the delivery

### Specifications

Material	Plate: Elastomer Thread: Polyamide Locknut: Polyamide
Colour	■ grey (similar RAL 7035)
Flame class	UL 94 V-0, self-extinguishing
IP rating	IP65 (certified acc. to EN 60529)
Temperature	-40°C to +100°C (static)
Properties	Halogen-free, silicone-free
Mounting height	8 mm
Thread length	14 mm
Wall thickness	max. 7 mm (M25 – M40) max. 6 mm (M50 – M63)
Cut-out	Metric cut-out

### Accessories

TE-M	334 - 337
------	-----------

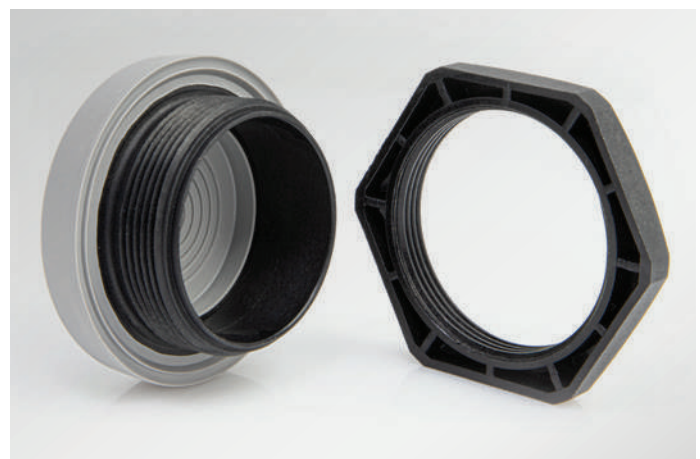
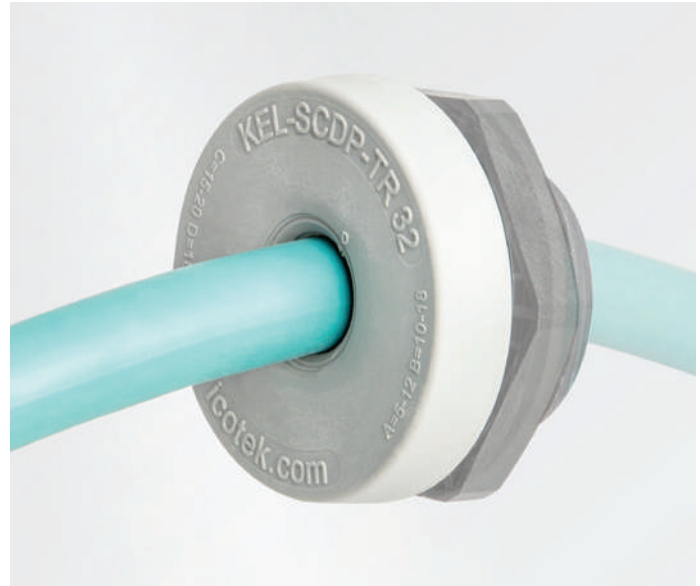

# KEL-SCDP-TR

## Cable entry plate

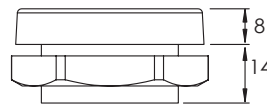
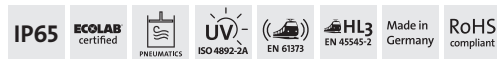

Type	Order No.	Number of cables	Thread metric	Thread length	Max. wall thickness	External diameter	Mounting height	PU	
	KEL-SCDP-TR 25	44070	1x 5 – 17 mm	M25 x 1.5	14 mm	7.0 mm	39 mm	8 mm	10
	KEL-SCDP-TR 32	44071	1x 5 – 23 mm	M32 x 1.5	14 mm	7.0 mm	44 mm	8 mm	10
	KEL-SCDP-TR 40	44072	1x 8 – 28 mm	M40 x 1.5	14 mm	7.0 mm	52 mm	8 mm	10
	KEL-SCDP-TR 50	44073	1x 8 – 38 mm	M50 x 1.5	14 mm	6.0 mm	62 mm	8 mm	10
	KEL-SCDP-TR 63   1	44074	1x 8 – 52 mm	M63 x 1.5	14 mm	6.0 mm	75 mm	8 mm	10
	KEL-SCDP-TR 63   5+1	44078	5x 5 – 13 mm 1x 50 – 52 mm	M63 x 1.5	14 mm	6.0 mm	75 mm	8 mm	10



Can be combined with TE-M thread extension

- 2
- 2.1
- 2.2
- 2.3
- 2.4
- 2.5
- 2.6
- 2.7
- 2.8

# KEL-SCDP | KEL-SCDP-RW

## Cable entry plate for plug-in assembly with IP65 rating



With the KEL-SCDP cable entry grommet, single cables, hoses, and conduits can be routed and sealed at a rating of IP65. Its unique advantage is the large sealing range.

The single circular membrane can be peeled away to accommodate the specific diameter of the cable or hose. No tooling is required to peel off the membrane. The peeled-off area is always round, ensuring a secure seal around the cable or the hose.

Another advantage is the high mounting flexibility. The KEL-SCDP can simply be plugged into cut-outs with wall thicknesses from 1.5 to 4.0 mm.

The version KEL-SCDP-RW is approved for the use in the railway technology in accordance with EN45545-2 HL3.

### Advantages & benefits

- Approved for the use in the railway technology (EN 45545-2, EN 45545-3 and EN 1363-1)
- Perfect edge protection and sealing
- Circular membranes can be peeled off easily
- Easy, tool-free assembly
- Protection class up to IP65

### Specifications

Material	Elastomer
Colour	■ grey (similar RAL 7035)
Flame class	UL 94 V-0, self-extinguishing
IP rating	IP65 (certified acc. to EN 60529)
Temperature	KEL-SCDP: -40°C to +80°C (static) KEL-SCDP-RW: -40°C to +90°C (static)
Properties	Halogen-free, silicone-free



*Due to high elasticity also suitable for routing preassembled cable lugs or terminals*



# KEL-SCDP | KEL-SCDP-RW

## Cable entry plate



	Type	Order No.	Number of cables	Clamping range mm	PU
	KEL-SCDP 25	■ 43480	1 max.	5 – 16 mm	10
	KEL-SCDP 32	■ 43481	1 max.	5 – 22 mm	10
	KEL-SCDP 40	■ 43482	1 max.	8 – 28 mm	10
	KEL-SCDP 50	■ 43483	1 max.	8 – 36 mm	10
<b>KEL-SCDP-RW for the use in the railway technology</b>					
	KEL-SCDP-RW 25	■ 43490	1 max.	5 – 16 mm	10
	KEL-SCDP-RW 32	■ 43491	1 max.	5 – 22 mm	10
	KEL-SCDP-RW 40	■ 43492	1 max.	8 – 28 mm	10
	KEL-SCDP-RW 50	■ 43493	1 max.	8 – 36 mm	10



The single membrane rings are peeled off according to the diameter of the routed cable or hose. For this purpose, only a small hole between the rings needs to be pierced. Then the corresponding ring can be removed.

- 2
- 2.1
- 2.2
- 2.3
- 2.4
- 2.5
- 2.6
- 2.7
- 2.8

\* Only valid for KEL-SCDP-RW

# KEL-DPF

## Cable entry grommet for screw-in assembly with IP66/IP68 rating



The KEL-DPF was developed particularly for routing large or unknown sizes of cables into a switch cabinet or machine (max. cable diameter 70 mm). Due to the flexibility and unique pyramid shape, cable entry and flexible positioning is much easier compared to using conventional cable glands. Also perfect for bundling or restraining large cables.

Cutting of DPF grommets: Cable diameter less 20%. The corresponding diameters are marked on the grommet.

It is recommended that additional strain relief be provided for cables using cable ties.

For mounting the KEL-DPF sizes 75 and 85 we offer suitable wrenches with widths for M75 and M85 plastic locknuts.

### Advantages & benefits

- Quick and tool-free assembly
- It is possible to install rigid cables at angles
- Suitable for metric cut-outs
- Polyamide locknuts are included in the shipment

### Specifications

Material	Thread frame: Polyamide (PA) Pyramid: Elastomer
Colour	■ grey (similar RAL 7035) ■ black
Flame class	UL 94 V-0, self-extinguishing
IP rating	IP66/ IP68 (certified acc. to EN 60529)
UL type rating	UL type 12 (acc. to UL 50E) UL type 4X (acc. to UL 50E)
Temperature	- 40°C to + 100°C (static)
Properties	Halogen-free, silicone-free
Thread length	11 mm; KEL-DPF 85 48-70: 14 mm
Cut-out dimensions	Metric sizes

### Accessories

FP Flanged plates	320 - 329
MP Module plates	314 - 315
TE-M	334 - 337



### Wrenches

for M75/M85 plastic locknuts

Material: Aluminium

M75: Order No.61436 | M85: Order No. 61437 | PU: 1



Due to high elasticity also suitable for routing preassembled cable lugs or terminals



Can be combined with TE-M thread extension

# KEL-DPF

## Cable entry grommets



Type	Order No.	Thread metric	External diameter	Clamping range	PU
	<ul style="list-style-type: none"> <li>■ 42652</li> <li>■ 50652</li> </ul>	M25 × 1.5	39 mm	3 – 12 mm	5
	<ul style="list-style-type: none"> <li>■ 42653</li> <li>■ 50653</li> </ul>	M32 × 1.5	46 mm	6 – 18 mm	5
	<ul style="list-style-type: none"> <li>■ 42654</li> <li>■ 50654</li> </ul>	M40 × 1.5	54 mm	12 – 27 mm	5
	<ul style="list-style-type: none"> <li>■ 42655</li> <li>■ 50655</li> </ul>	M50 × 1.5	64 mm	22 – 36 mm	5
	<ul style="list-style-type: none"> <li>■ 42656</li> <li>■ 50656</li> </ul>	M63 × 1.5	77 mm	27 – 50 mm	5
	<ul style="list-style-type: none"> <li>■ 42657</li> <li>■ 50657</li> </ul>	M75 × 1.5	89 mm	39 – 60 mm	1
	<ul style="list-style-type: none"> <li>■ 42658</li> <li>■ 50658</li> </ul>	M85 × 2	99 mm	48 – 70 mm	1

2  
2.1  
2.2  
2.3  
2.4  
2.5  
2.6  
2.7  
**2.8**

# KEL-ULTRA flex

## Cable entry grommets



The KEL-ULTRA flex is designed as a cable entry grommet for any large cable or conduit that is difficult to manage. The KEL-ULTRA flex comes in two sizes and is ideal for routing and sealing cables and conduits with a diameter from 25 to 115 mm. Due to the high flexibility of the elastomer pyramid, inserting large, thick cables with KEL-ULTRA flex is easier than using standard cable glands.

After inserting the cable or conduit, the KEL-ULTRA flex is quickly and easily mounted with the metal ring and screws. This ring enables a circular fixing and sealing of the grommet at the enclosure wall. The ring is supplied with each KEL-ULTRA flex. Cutting of grommets: Cable diameter less 25%. It is recommended that additional strain relief be provided for cables as part of the installation.

### Advantages & benefits

- Quick assembly
- Grommets allow easy orientation and seal of rigid cables
- IP66/up to UL type 12 rating

### Specifications

Material	Pyramid: Elastomer Fixing metal ring: Steel, zinc-plated Blind plate: Steel, zinc-plated
Flame class	UL 94 V-0, self-extinguishing
IP rating	IP66, when fastened with 8 screws (certified acc. to EN 60529)
UL type rating	UL type 12 (acc. to UL 50E)
Temperature	- 40°C to + 100°C (static)
Properties	Halogen-free, silicone-free
Cut-out dimension	Round, $\phi$ -cable +30%, max. $\phi$ 140 mm

### Accessories

MP Module plates	314 - 315
BPM Blank plates	331

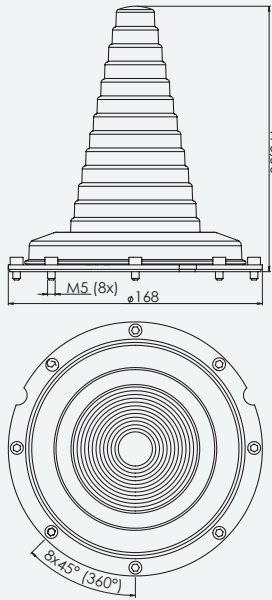
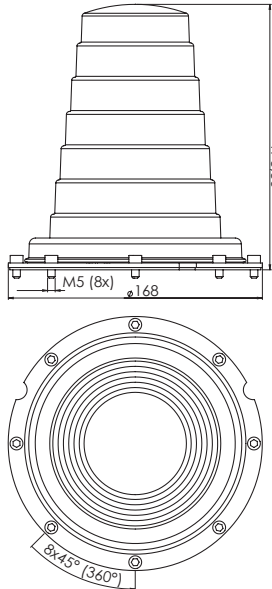

Description	Type	Order No.	Sealing range	PU
	KEL-ULTRA flex 1 incl. fixing screws	42630	25 - max. 90 mm cable diameter	1
	KEL-ULTRA flex 2 incl. fixing screws	42631	75 - max. 115 mm cable diameter	1



# KEL-JUMBO flex

## Cable entry grommets



The KEL-JUMBO flex is a flexible cable entry grommet for cables without connectors with a diameter range from 27 – 68 mm.

They are ideal for the routing supply cables into the switch cabinets.

Cutting of KEL-JUMBO flex grommets:  
Cable diameter less 25%. The corresponding diameters are marked on the grommet.

It is recommended that additional strain relief be provided for cables as part of the installation.

### Advantages & benefits

- Quick assembly
- Grommets allow dynamic and flexible movement of rigid cables
- Compact installation area (88 × 88 mm)

### Specifications

Material	Frame: Polyamide (PA) Pyramid: Elastomer
Flame class	UL 94 V-0, self-extinguishing
IP rating	IP54
UL type rating	UL type 12 (acc. to UL 50E)
Temperature	-40°C to +100°C (static)
Properties	Halogen-free, silicone-free
Cut-out dimensions	Round, $\phi$ -cable +20%

### Accessories

MP Module plates	314 - 315
BP Blank plates	331

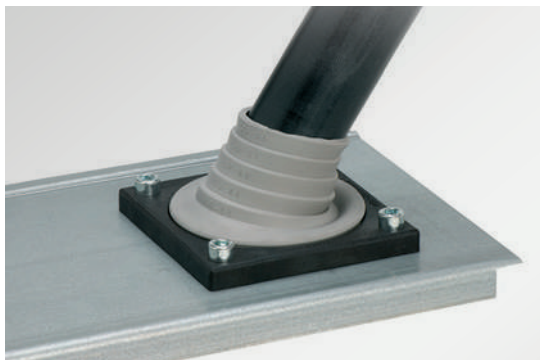

Description	Type	Order No.	Clamping range	PU
	KEL-JUMBO flex 27-48	42614	27 - 48 mm	1
	KEL-JUMBO flex 47-68	42616	47 - 68 mm	1

- 2
- 2.1
- 2.2
- 2.3
- 2.4
- 2.5
- 2.6
- 2.7
- 2.8

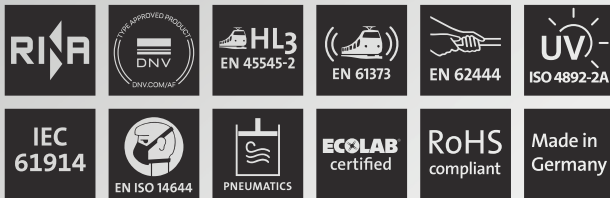

# Strain relief and cable management

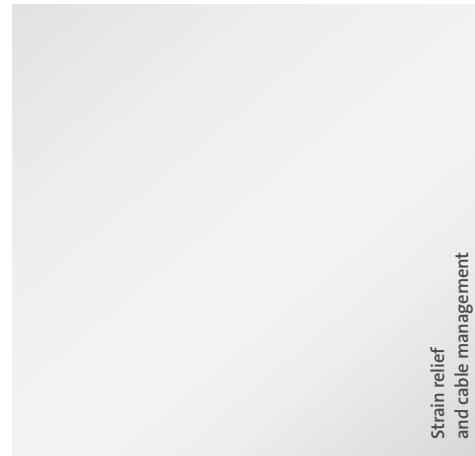
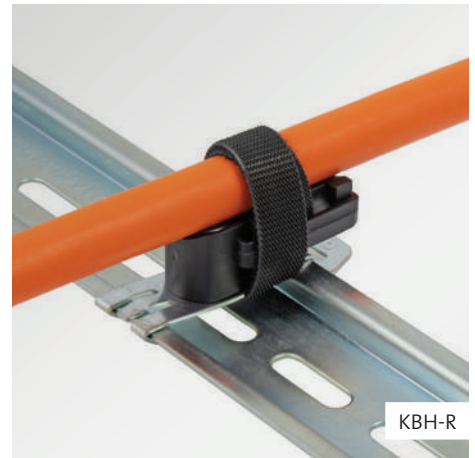
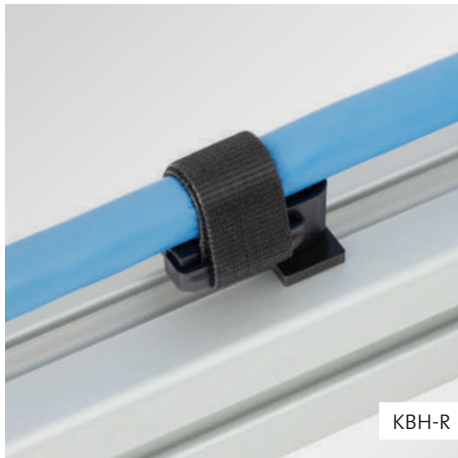

Strain relief  
and cable management

- 3
- 3.1
- 3.2
- 3.3

### 3 Strain relief and cable management



#### Best secured and structured: Strain relief and cable routing

With icotek's universal strain relief and cable routing systems, cables, wires and hoses can be quickly, safely and cleanly assembled and strain relieved at the same time. This is possible under both static and dynamic loads.

With the strain relief systems, cables can be routed quickly, safely and cleanly and strain relieved in accordance with EN 62444. The possible applications range from routing cables on machines, control cabinets and enclosures to cable carriers.

Various assembly options, e.g. for top-hat rail, C-rail or direct mounting, offer a wide range of possible applications. The cables are mounted using standard cable ties.

Cable ties with hook-and-loop fasteners are an increasingly common fixing mode for cables. Various holders serve as holders for hook-and-loop fasteners, which can be mounted quickly and easily in a variety of ways.

The modular stackable cable clamp MSMC is used for cable routing and strain relief, especially for cables with large diameters and large bending radii, according to IEC 61914.

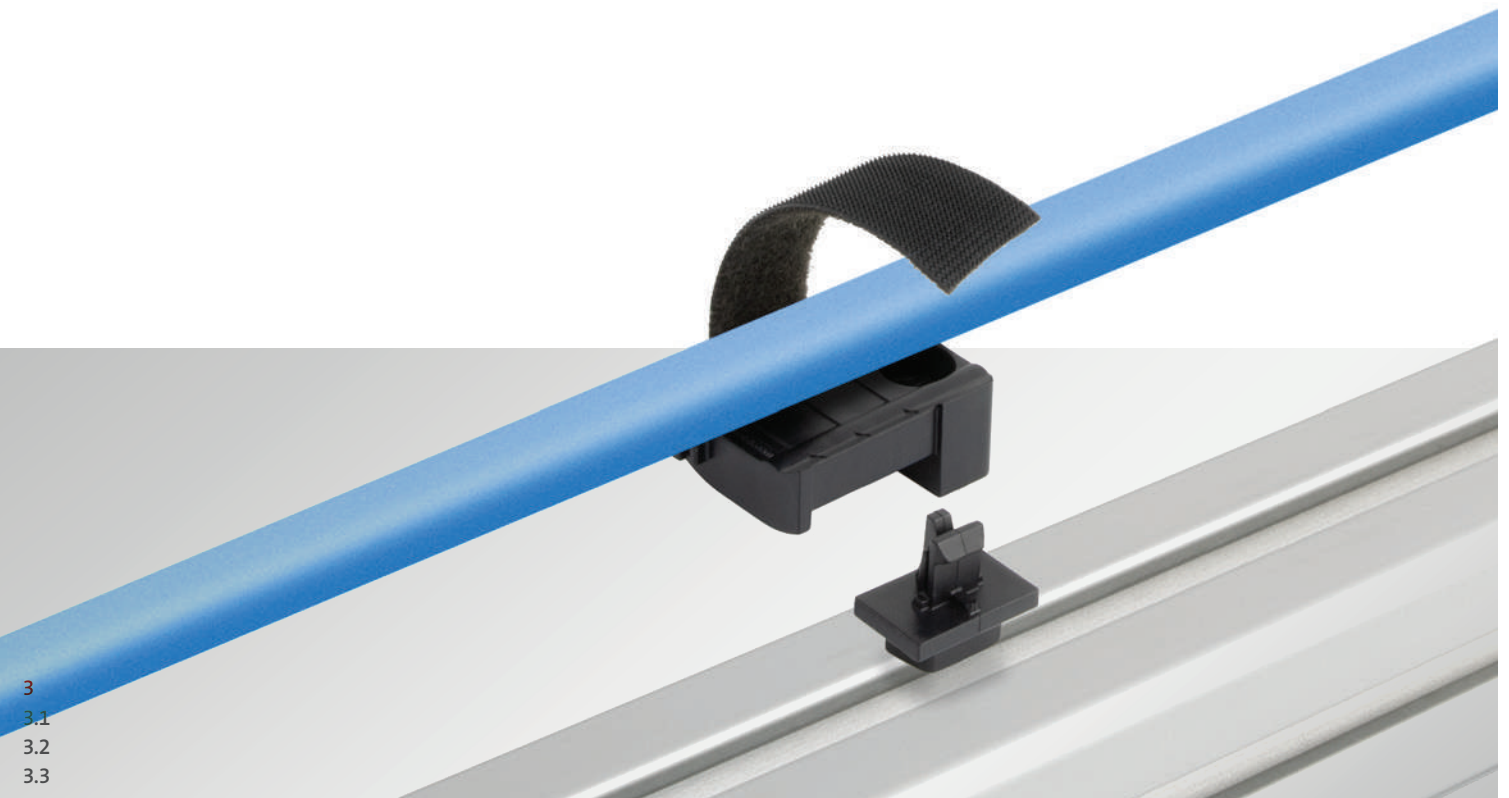

3  
3.1  
3.2  
3.3

Product range strain relief, MSMC	Strain relief	Strain relief acc. to EN 62444	IEC 61914	Screw assembly	Assembly on DIN rails	Assembly on C-rails	Page
CCL	●					●	192 – 193
ZL	●	●		●			194
ZL-AB / ZL-MS	●	●		●			195
ZL 03 / 04 / 05	●	●		●			196
KZL	●	●			●	●	197
SF ZL	●	●			●		198
MSMC	●		●	●		●	216 – 219

Product range cable management	compatible with	Page
KBH-S M5	universal	204
KBH-R R MS	Rittal punched section and punched rail	205
KBH-R M G8	MiniTec profile with 8 mm groove	206
KBH-R M-I G8	MiniTec, Item profile with 8 mm groove	206
KBH-R B-R G8	Bosch Rexroth profile with 8 mm groove	207
KBH-R B-R G10	Bosch Rexroth profile with 10 mm groove	207
KBH-R I G6	Item profile with 6 mm groove	208
KBH-R May-G8	Maytec PG40 profile with 8 mm groove	208
KBH-R P80/20	80/20 profile	209
KBH-R SF-M4	35 mm top hat DIN rail	210
KBH-R 12-SC	C-rails with an opening dimension of 16 mm	210
KBH-R 12-C	C-rails with an opening dimension of 16 mm	210
KBH-R 9,5	19" system punching 9.5 x 9.5 mm	211
KBH-KS	universal, self-adhesive	211
KBH-S	23 x 23 mm mounting rail	214
KBH-SB	universal	214
KBH-R	23 x 23 mm mounting rail systems for Rittal VX25	214
KBH-RBA	drill-hole ø 6 mm	214
KBH-RBB	drill-hole ø 6.5 mm	214
KLKB	universal	215
KLB	universal	215

3  
3.1  
3.2  
3.3

### 3.1 Systems for strain relief



Space-saving solution for mounting on C-rails



High cable density, multilayer mounting possible



Fast and easy, partially tool-free mounting



Wide mounting type variety: top hat DIN rail/C-rail snap mount, screw mount



Available in various sizes



Secure hold of the cable ties and cables, strain relief acc. to EN 62444



- 3
- 3.1
- 3.2
- 3.3



Cable clamp  
for C-rail mount

CCL

192 – 193



Strain relief plates  
for screw mount

ZL

194



Strain relief plates  
for screw mount, with bushings

ZL-AB / ZL-MS

195



Strain relief plates  
for screw mount, for various cable diameters

ZL 03 | 04 | 05

196



Strain relief plates  
for 35 mm top hat DIN rail/C-rail snap mount

KZL

197



Strain relief plates  
for 35 mm top hat DIN rail snap mount

SF|ZL

198



Spacers  
for multilayer mounting of strain relief  
plates

DH

196



EMC Strain relief plates

KAFM-EMC

264



Shield plate  
for ZL strain relief plates

ZL|SB-EMC

265

# CCL

## Cable clamp for C-rails

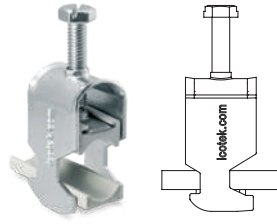

The cable clamps are characterised by a high clamping range and great flexibility. Ideally suited for strain relief on the C-rail for opening dimensions 16 – 17 mm. It offers flexible clamping ranges from 6 mm to 64 mm.

The counter trough integrated in the cable clamp is secured by a locking mechanism and cannot slip out of the cable clamp under tensile load.

### Advantages & benefits

- Quick and easy assembly
- Tool-free and space-saving assembly
- Large variety of clamping areas from 6 to 64 mm
- High packing density
- For mounting on all common C-rails with 16 – 17 mm opening dimensions

### Specifications

Material Galvanised steel

### Accessories

EMC shield clamps for 30 mm C-rails 242 - 245

Type	Clamping range	Order No.	PU
CCL 6-13	6 – 13 mm	32000	25
CCL 12-19	12 – 19 mm	32001	25
CCL 18-23	18 – 23 mm	32002	25
CCL 22-32	22 – 32 mm	32003	25
CCL 30-38	30 – 38 mm	32004	25
CCL 38-42	38 – 42 mm	32005	25
CCL 42-50	42 – 50 mm	32006	25
CCL 50-64	50 – 64 mm	32007	25





# CCL

## Plastic counter trough (spare part)

RoHS  
compliant

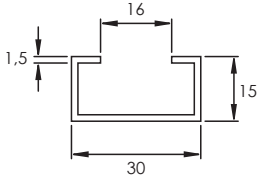

C-rail dimensions (mm)

### Plastic counter trough (spare part)

Type	suitable for cable clamp	Order No.	PU
Counter trough Y 6/12	CCL 6-13	99215	50
Counter trough Y 12/18	CCL 12-19	99216	50
Counter trough Y 16/22	CCL 18-23	99217	50
Counter trough Y 22/38	CCL 22-32, CCL 30-38, CCL 38-42	99218	50
Counter trough Y 42/64	CCL 42-50, CCL 50-64	99219	50

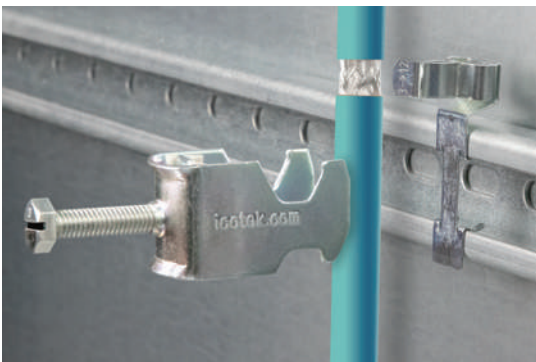

LFC/MSKL and CCL



Applications on the C-Rail with cable clamp CCL



3  
3.1  
3.2  
3.3

# ZL

## Strain relief plates for screw assembly



The strain relief plate ZL is used for static or dynamic applications for organising and securing cables on machines, control panels or drag chains.

The design of the strain relief unit provides secure strain relief according to EN 62444. Mount of the cables or pneumatic tubing is easily done using cable ties.

For multilayer installation please use DH spacers.

### Advantages & benefits

- Strain relief according to EN 62444
- Easy assembly
- Cost-effective
- High cable density
- Wide variety of mounting options
- Vibration proof

### Specifications

Material	Polyamide (PA)
Flame class	UL 94 V-0, self-extinguishing
Temperature	-40°C to +140°C (static)
Properties	Halogen-free, silicone-free

### Accessories

DH Spacers	196
Mounting feet	235
ZL SB-EMC Shield plates	265

Type	Order No.	Length L1	Length L2	No. of teeth	PU
ZL 39	32222	38.5 mm	19.5 mm	3	10
ZL 60	32224	59.5 mm	43.5 mm	4	10
ZL 70	32226	69.1 mm	43.5 mm	5	10
ZL 87	32228	86.5 mm	68 mm	6	10
ZL 103	32230	102.5 mm	84 mm	7	10
ZL 121	32232	121 mm	102.5 mm	8	10
ZL 140	32234	139.5 mm	121 mm	9	10
ZL 180	32236	180 mm	157 mm	12	10

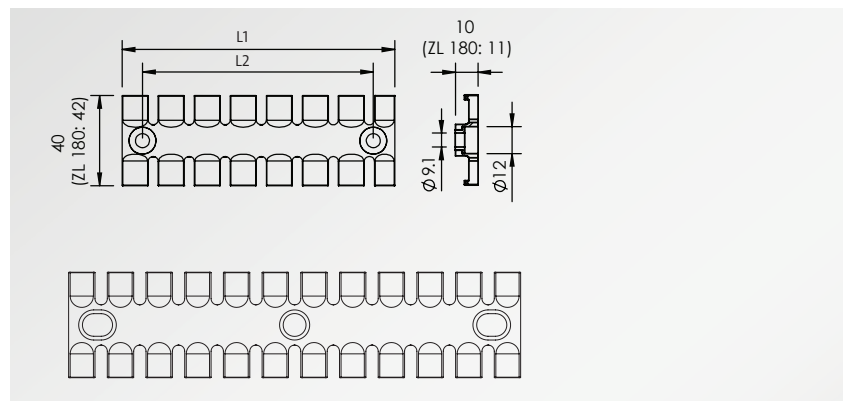

ZL 180

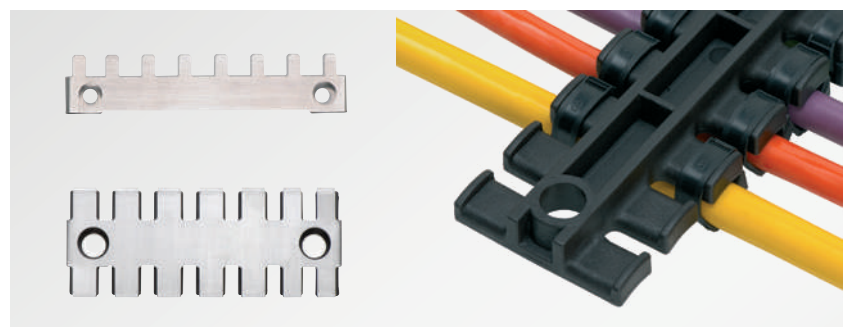

ZL|SB-EMV

ZL

# ZL-AB | ZL-MS

## Strain relief plates for screw assembly

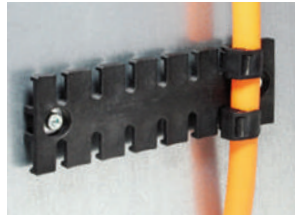

The strain relief plate ZL-AB / ZL-MS is used for static or dynamic applications for organising and securing cables on machines, control panels or drag chains.

By using aluminium / brass nuts for the screw holes, a better fit of the strain relief plate is achieved, even in high vibration environments.

### Advantages & benefits

- Strain relief according to EN 62444
- Easy assembly
- Cost-effective
- High cable density
- Wide variety of mounting options
- Vibration proof

### Specifications

Material	ZL: Polyamide (PA) Bushing: Aluminium (ZL-AB) Brass (ZL-MS)
Flame class	UL 94 V-0, self-extinguishing
Temperature	-40°C to +140°C (static)
Properties	Halogen-free, silicone-free

### Accessories

ZL|SB-EMC Shield plates 265

Type	Order No. for M4 screws	Order No. for M5 screws	Order No. for M6 screws	Length L1	Length L2	No. of teeth	PU
ZL 39 AB ZL 39 MS	■ 32270	■ 32280 ■ 32360	■ 32290	38.5 mm	19.5 mm	3	10
ZL 60 AB ZL 60 MS	■ 32271	■ 32281 ■ 32361	■ 32291	59.5 mm	43.5 mm	4	10
ZL 70 AB ZL 70 MS	■ 32272	■ 32282 ■ 32362	■ 32292	69.1 mm	43.5 mm	5	10
ZL 87 AB ZL 87 MS	■ 32273	■ 32283 ■ 32363	■ 32293	86.5 mm	68 mm	6	10
ZL 103 AB ZL 103 MS	■ 32275	■ 32284 ■ 32364	■ 32294	102.5 mm	84 mm	7	10
ZL 121 AB ZL 121 MS	■ 32277	■ 32285 ■ 32365	■ 32295	121 mm	102.5 mm	8	10
ZL 140 AB ZL 140 MS	■ 32274	■ 32286 ■ 32366	■ 32296	139.5 mm	121 mm	9	10
ZL 180 AB ZL 180 MS	■ 32276	■ 32287 ■ 32367	■ 32297	180 mm	157 mm	12	10

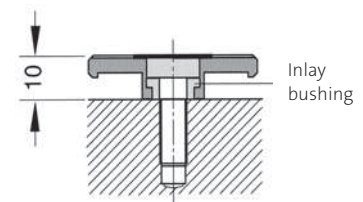
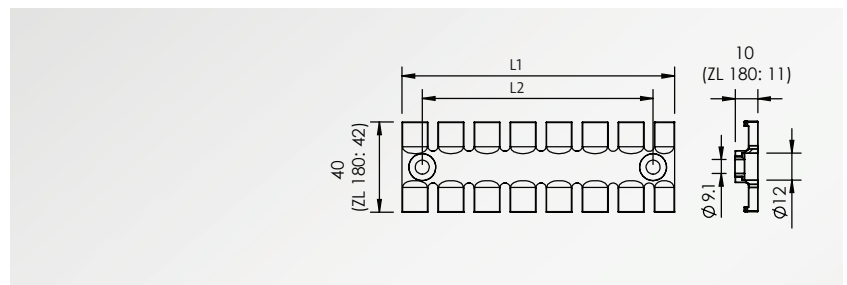

Inlay bushings are also available in brass

## ZL 03 | 04 | 05

Strain relief plates  
for screw assembly  
for various cable diameters



Strain relief plates ZL feature different comb widths. Thus providing a multi-purpose product for various cable sizes. The design of the strain relief unit provides secure strain relief according to EN 62444. Mount of the cables or pneumatic tubing is easily done using cable ties.

### Advantages & benefits

- Strain relief according to EN 62444
- Easy assembly
- Cost-effective
- High cable density
- Wide variety of mounting options
- Vibration proof

### Specifications

Material	Polyamide (PA)
Flame class	UL 94 V-0, self-extinguishing
Temperature	-40°C to +140°C (static)
Properties	Halogen-free, silicone-free

Type	Order No.	Length L1	Length L2	No. of teeth	PU
ZL 03	32112	63.4 mm	42 mm	4 7	10
ZL 04	32114	95 mm	74.5 mm	6 11	10
ZL 05	32116	119 mm	108 mm	7 13	10

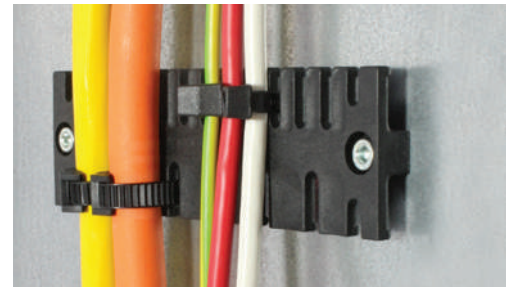
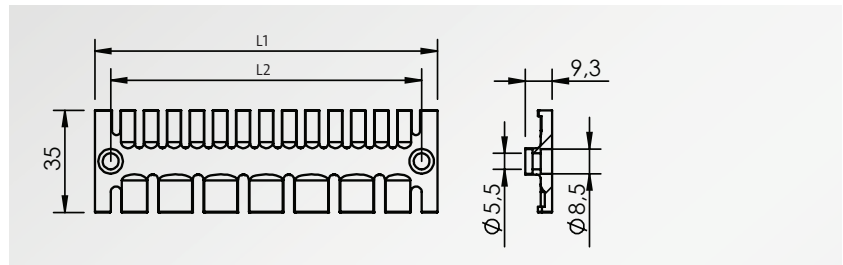

## DH Spacers

Due to DH spacers strain relief plates can be mounted in multi-layers to achieve an increase of the cable density.

### Advantages & benefits

- Increase of cable density

### Specifications

Material	Aluminium
----------	-----------

### Compatible with

ZL Strain relief plates	194
ZL 03 04 05 Strain relief plates	196

Type	Order No.	Fits with	Length	Diameter		PU
				inner	outer	
DH 30	32251	ZL 03   04   05	30 mm	5.2 mm	8.5 mm	10
DH 32	32252	ZL	32 mm	6.2 mm	12 mm	10

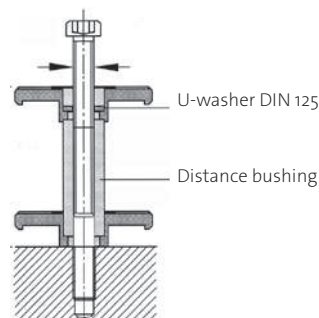

# KZL

## Strain relief plates for mounting rails

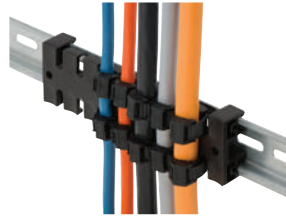

The strain relief plate KZL is used for static or dynamic applications for organising and securing cables on machines, control panels or drag chains.

The design of the strain relief unit provides secure strain relief according to EN 62444. Mount of the cables or pneumatic tubing is easily done using cable ties.

KZL Strain relief plates can be mounted on 30 mm DIN rails (C-rails) and 35 mm top hat DIN rails.

### Advantages & benefits

- Strain relief according to EN 62444
- Easy assembly
- Cost-effective
- High cable density
- Wide variety of mounting options
- Vibration proof

### Specifications

Material	Polyamide (PA)
Flame class	UL 94 V-0, self-extinguishing
Temperature	-40°C to +140°C (static)
Properties	Halogen-free, silicone-free

Type	Order No.	Length L1	Length L2	No. of teeth	PU
KZL 11	32250	11.5 mm	–	1	10
KZL 39	32260	38.5 mm	28.3 mm	3	10
KZL 80	32262	79.5 mm	68 mm	6	10
KZL 140	32264	139.5 mm	128.1 mm	9	10

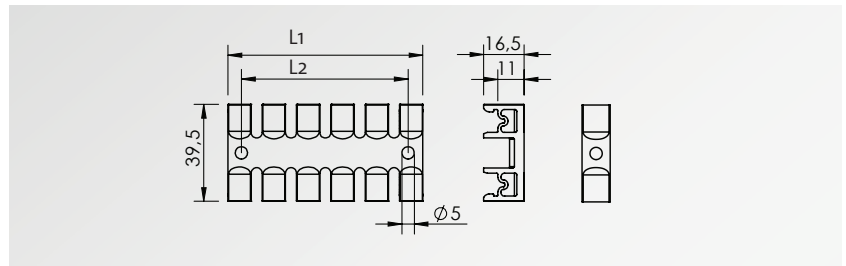

# SF|ZL

## Strain relief plates for 35 mm top hat DIN rail

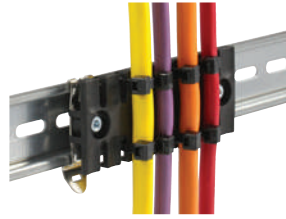

The strain relief plate SF|ZL is used for assembly on 35 mm top hat DIN rails. It can be used for strain relief of cables and conduits.

The SF|ZL range is based upon the strain relief plate ZL, which is mounted on snap feet for 35 mm top hat DIN rails.

### Advantages & benefits

- Strain relief according to EN 62444
- Easy assembly
- Cost-effective
- High cable density
- Wide variety of mounting options

### Specifications

Material	ZL: Polyamide (PA)
SF-foot:	Spring steel
Flame class	UL 94 V-o, self-extinguishing
Temperature	-40°C to +140°C (static)
Properties	Halogen-free, silicone-free

### Accessories

ZL|SB-EMC Shield plates 265

Type	Order No.	Length L1	Length L2	No. of teeth	PU
SF ZL 39	32351	38.5 mm	19.5 mm	3	10
SF ZL 60	32352	59.5 mm	43.5 mm	4	10
SF ZL 70	32353	69.1 mm	43.5 mm	5	10
SF ZL 87	32354	86.5 mm	68 mm	6	10
SF ZL 103	32355	102.5 mm	84 mm	7	10
SF ZL 121	32356	121 mm	102.5 mm	8	10
SF ZL 140	32357	139.5 mm	121 mm	9	10
SF ZL 180	32358	180 mm	157 mm	12	10

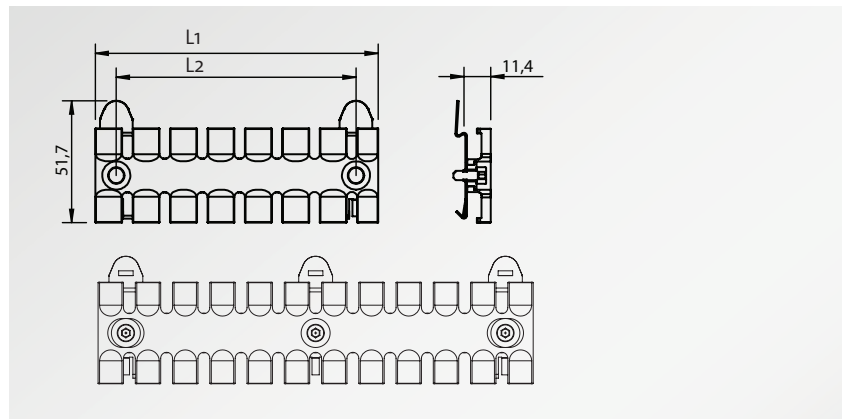

SF|ZL 180

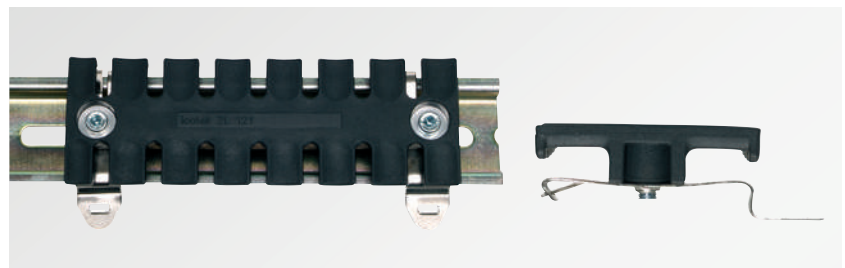

## Typical applications



**ZL 180**  
Packaging machines



**ZL**  
Automation

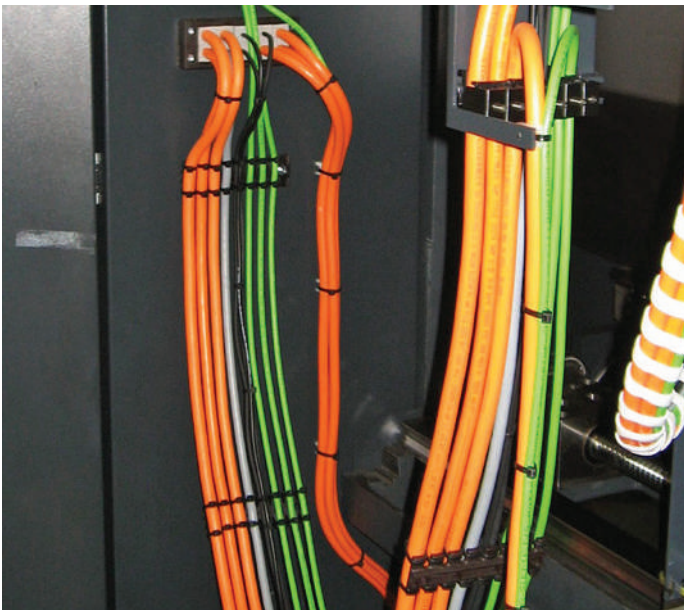

**ZL 180**  
Machine tools

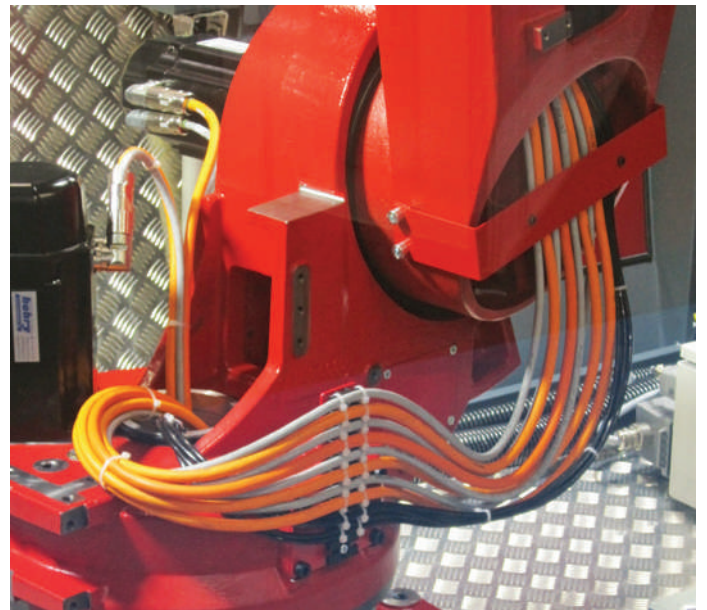

**ZL 180**  
Robotics

## 3.2 Systems for cable management

Organise, bundle, fix:  
Hook-and-loop fasteners,  
holders for hook-and-loop fasteners

Cable ties with hook-and-loop fasteners are an increasingly common fixing mode for cables. They are used instead of standard cable ties, because they can be easily closed and opened several times. The soft material is gentle on cables, especially where vibrations are present.

Various holders serve as holders for hook-and-loop fasteners, which can be mounted quickly and easily in a variety of ways.



High cable density,  
multilayer mounting  
possible



Gentle on cables,  
especially during vibrations

No sharp edges,  
no risk of injury



Subsequent removal or addition  
of cables is easily possible

Very quick assembly thanks  
to 90° rotation lock



Available for numerous  
aluminium profiles and  
construction profiles

Different routing directions of the  
cables are possible



Available in three sizes:  
12, 24 and 36 mm

Very fast assembly,  
screwable





**Holders for hook-and-loop cable ties**  
 Assembly with screws,  
 suitable for hook-and-loop tape KLB and  
 hook-and-loop fastener KLKB

KBH-S

204

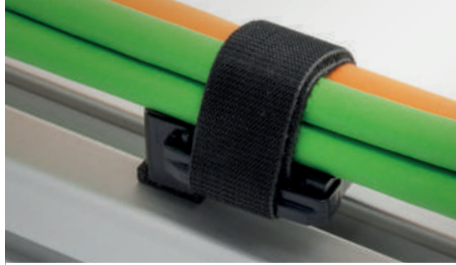

**Holders for hook-and-loop cable ties**  
 Pluggable,  
 for numerous profiles: Rittal, MiniTec, Item,  
 Bosch Rexroth, Maytec, 80/20,  
 suitable for hook-and-loop tape KLB and  
 hook-and-loop fastener KLKB

KBH-R

205 – 209

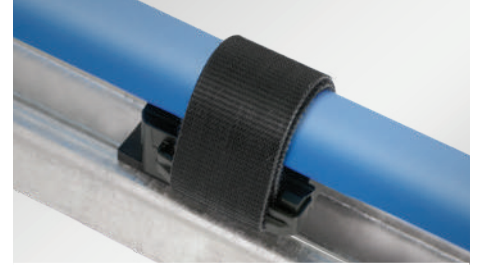

**Holders for hook-and-loop cable ties**  
 Pluggable,  
 for top-hat rail, C-rail, 19" system punchings,  
 suitable for hook-and-loop tape KLB and  
 hook-and-loop fastener KLKB

KBH-R

210 – 211

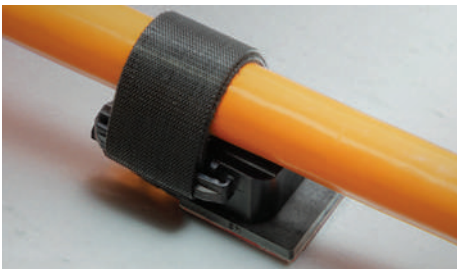

**Holders for hook-and-loop cable ties**  
 Assembly: self-adhesive,  
 suitable for hook-and-loop tape KLB and  
 hook-and-loop fastener KLKB

KBH-KS

211

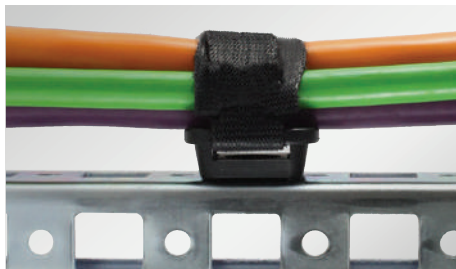

**Holders for hook-and-loop cable ties**  
 Assembly with screws, pluggable,  
 universal, for mounting rail systems,  
 suitable for KLB and KLKB  
 KBH-S / KBH-R / KBH-R-TX / KBH-SB /  
 KBH-RBA / KBH-RBB

214



**KBH ServiceBox**  
 Service boxes for KBH holders,  
 Assembly with screws, pluggable,  
 available for numerous profiles

KBH-S ServiceBox / KBH-R ServiceBox

212 – 213



**Hook-and-loop cable ties**  
 for cable management,  
 resealable, re-usable,  
 available in four sizes or as a continuous roll

KLKB / KLB

215

3  
 3.1  
 3.2  
 3.3

# KBH

## Holders for hook-and-loop cable ties

The holders for hook-and-loop fasteners KBH-S and KBH-R serve as universal holders and as cable routing systems for the hook-and-loop tape KLB and the hook-and-loop fastener KLKB.

With the KBH-R holder, cables can be routed in different directions. The 90° twist lock makes it very easy to mount.

Due to the two-part design of the KBH-R hook-and-loop holder, the cable plate (upper part) can be fixed parallel or at an angle to the profile, depending on the desired cable routing direction. If cables are added or removed later, the cable plate sizes can be changed flexibly.

### Advantages & benefits KBH-S

- Available in three sizes: 12, 24 and 36 mm
- Very fast assembly, screwable
- Suitable for hook-and-loop tape KLB and hook-and-loop fastener KLKB

### Advantages & benefits KBH-R

- Available in three sizes: 12, 24 and 36 mm
- Very fast assembly due to 90° twist lock
- Suitable for hook-and-loop tape KLB and hook-and-loop fastener KLKB
- Available for numerous aluminium profiles and construction profiles
- Different guiding directions of the cables possible
- Subsequent removal or addition of cables is easily possible

### Specifications KBH-S, KBH-R

Material	Polyamide (PA)
Colour	Black
Flame class	UL 94 V-0, self-extinguishing
Temperature	-40°C to +140°C
Properties	Halogen-free, silicone-free

### Compatible with

KLKB/KLB Cable ties  
with hook-and-loop fastener 215

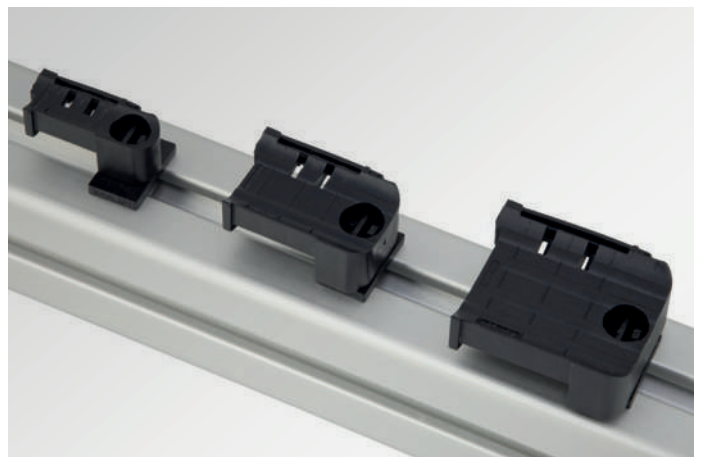
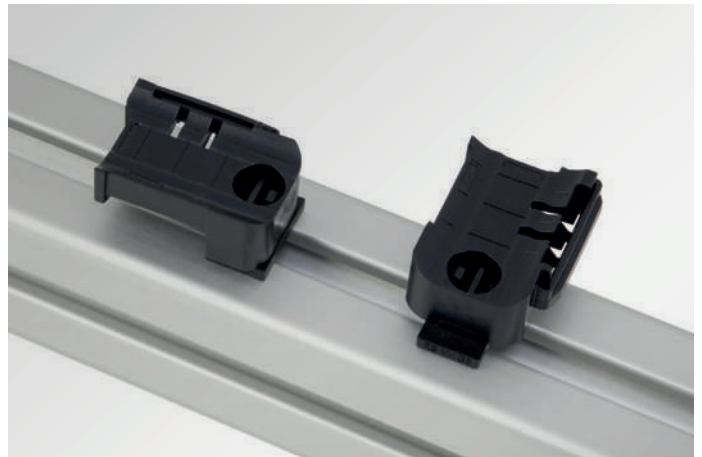

## Assembly KBH-R

- Very fast assembly due to 90° twist lock
- Different guiding directions of the cables possible

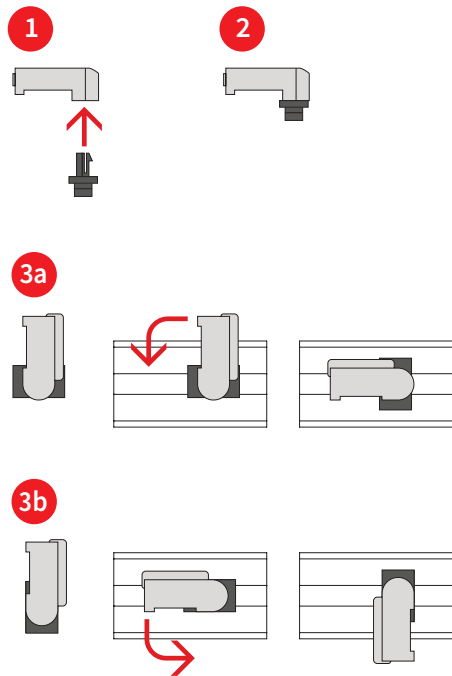

## Disassembly KBH-R

Removal of the cable plate

- Insert the screwdriver past the locking lug all the way down (1)
- Hold the screwdriver down and press the handle in the direction of the locking lug (2)
- The plate of the holder is released and can then be removed from the base
- The plate must be mounted to release the base

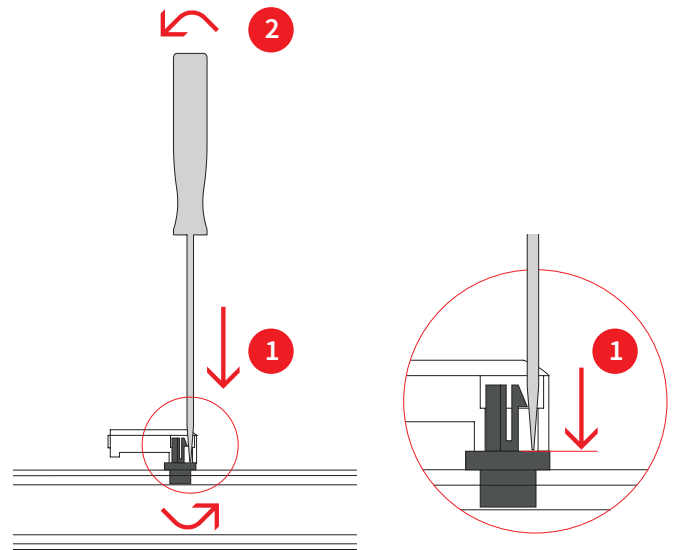

KBH-R



3  
3.1  
3.2  
3.3

# KBH-S

## Holders for hook-and-loop cable ties



Type	Order No.	fits KLKB   KLB	compatible with	PU
<b>Holder for hook-and-loop fastener, assembly with screws</b>				
KBH-S 12 M5	61030	KLKB 200 x 13 KLB 10 KLB 15	universal	10
	61030.9005			50
KBH-S 24 M5	61031	KLKB 200 x 13 KLB 10 KLB 15 KLB 20	universal	10
	61031.9005			50
KBH-S 36-1 M5	61032	KLKB 300 x 17 KLB 15 KLB 20 KLB 25	universal	10
	61032.9005			50
KBH-S 36-2 M5	61033	KLKB 300 x 17 KLB 15 KLB 20 KLB 25	universal	10
	61033.9005			50



# KBH-R

## Holders for hook-and-loop cable ties

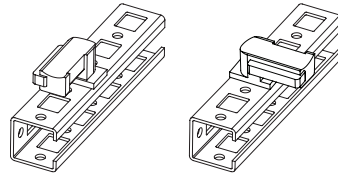

Type	Order No.	fits KLKB   KLB	compatible with	PU
<b>Holder for hook-and-loop fastener for Rittal punched section and punched rail</b>				
KBH-R 12 R MS Holder for hook-and-loop fastener, pluggable	61045	KLKB 200 x 13 KLB 10 KLB 15	Rittal punched section and punched rail	10
	61045.9005			50
KBH-R 24 R MS Holder for hook-and-loop fastener, pluggable	61046	KLKB 200 x 13 KLB 10 KLB 15 KLB 20	Rittal punched section and punched rail	10
	61046.9005			50
KBH-R 36-1 R MS Holder for hook-and-loop fastener, pluggable	61047	KLKB 300 x 17 KLB 15 KLB 20 KLB 25	Rittal punched section and punched rail	10
	61047.9005			50

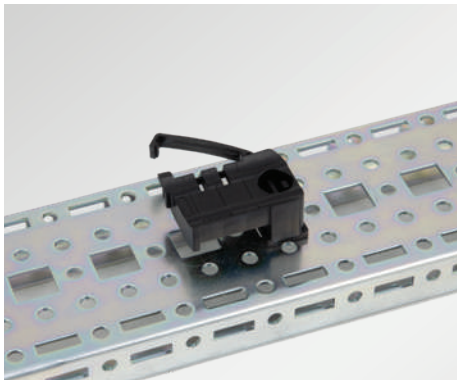
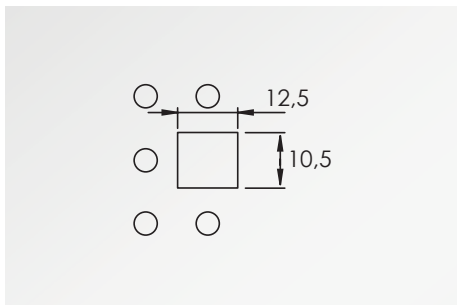

Rittal punched section

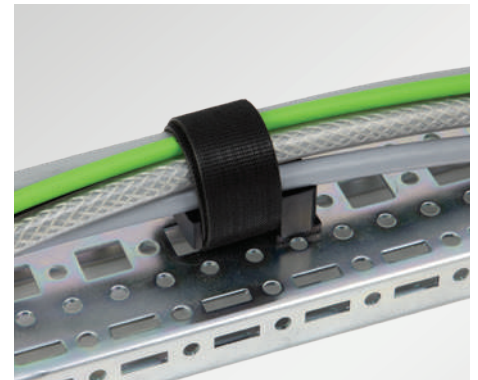
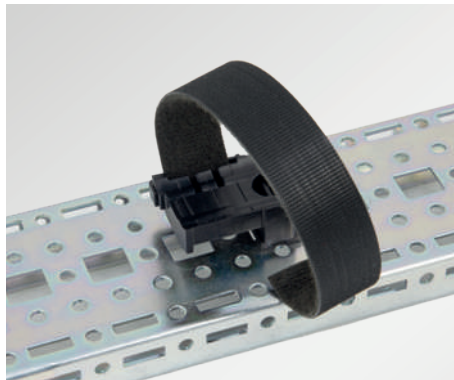

3  
3.1  
3.2  
3.3

# KBH-R



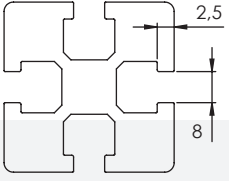
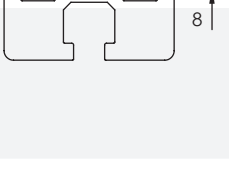
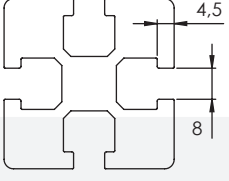
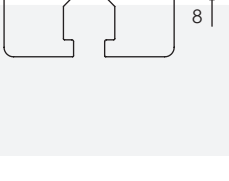

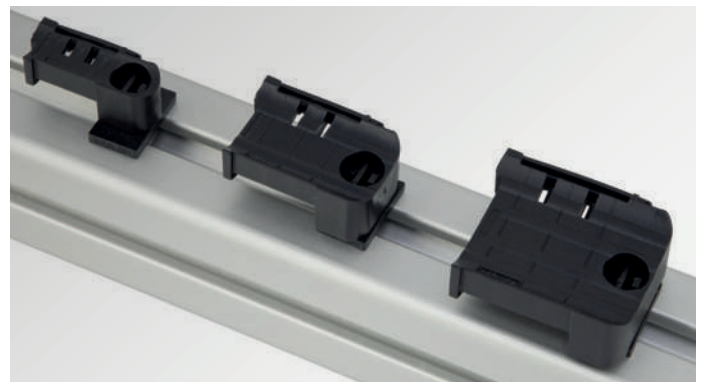
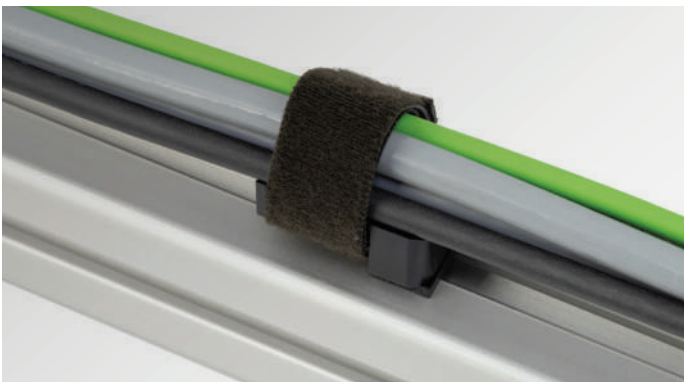
## Holders for hook-and-loop cable ties

Type	Order No.	fits KLKB   KLB	compatible with	PU	
<b>Holder for hook-and-loop fastener for MiniTec</b>					
	KBH-R 12 M G8 Holder for hook-and-loop fastener, pluggable	61048	KLKB 200 x 13 KLB 10 KLB 15	MiniTec with 8 mm groove	10
	61048.9005			50	
	KBH-R 24 M G8 Holder for hook-and-loop fastener, pluggable	61049	KLKB 200 x 13 KLB 10 KLB 15 KLB 20	MiniTec with 8 mm groove	10
	61049.9005			50	
	KBH-R 36-1 M G8 Holder for hook-and-loop fastener, pluggable	61050	KLKB 300 x 17 KLB 15 KLB 20 KLB 25	MiniTec with 8 mm groove	10
	61050.9005				50
<b>Holder for hook-and-loop fastener for Minitec and Item</b>					
	KBH-R 12 M-I G8 Holder for hook-and-loop fastener, pluggable	61051	KLKB 200 x 13 KLB 10 KLB 15	MiniTec, Item with 8 mm groove	10
	61051.9005			50	
	KBH-R 24 M-I G8 Holder for hook-and-loop fastener, pluggable	61052	KLKB 200 x 13 KLB 10 KLB 15 KLB 20	MiniTec, Item with 8 mm groove	10
	61052.9005			50	
	KBH-R 36-1 M-I G8 Holder for hook-and-loop fastener, pluggable	61053	KLKB 300 x 17 KLB 15 KLB 20 KLB 25	MiniTec, Item with 8 mm groove	10
	61053.9005				50

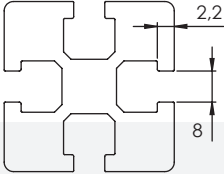

# KBH-R

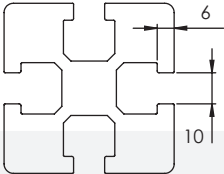
## Holders for hook-and-loop cable ties

Type	Order No.	fits KLKB   KLB	compatible with	PU	
<b>Holder for hook-and-loop fastener for Bosch Rexroth, with 8 mm groove</b>					
	KBH-R 12 B-R G8 Holder for hook-and-loop fastener, pluggable	61054	KLKB 200 x 13 KLB 10 KLB 15	Bosch Rexroth with 8 mm groove	10
		61054.9005			50
	KBH-R 24 B-R G8 Holder for hook-and-loop fastener, pluggable	61055	KLKB 200 x 13 KLB 10 KLB 15 KLB 20	Bosch Rexroth with 8 mm groove	10
		61055.9005			50
	KBH-R 36-1 B-R G8 Holder for hook-and-loop fastener, pluggable	61056	KLKB 300 x 17 KLB 15 KLB 20 KLB 25	Bosch Rexroth with 8 mm groove	10
		61056.9005			50
<b>Holder for hook-and-loop fastener for Bosch Rexroth, with 10 mm groove</b>					
	KBH-R 12 B-R G10 Holder for hook-and-loop fastener, pluggable	61057	KLKB 200 x 13 KLB 10 KLB 15	Bosch Rexroth with 10 mm groove	10
		61057.9005			50
	KBH-R 24 B-R G10 Holder for hook-and-loop fastener, pluggable	61058	KLKB 200 x 13 KLB 10 KLB 15 KLB 20	Bosch Rexroth with 10 mm groove	10
		61058.9005			50
	KBH-R 36-1 B-R G10 Holder for hook-and-loop fastener, pluggable	61059	KLKB 300 x 17 KLB 15 KLB 20 KLB 25	Bosch Rexroth with 10 mm groove	10
		61059.9005			50

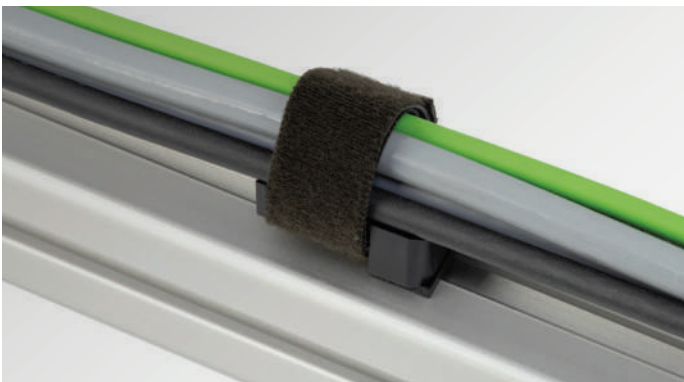

3  
 3.1  
 3.2  
 3.3

# KBH-R

## Holders for hook-and-loop cable ties

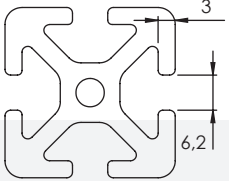
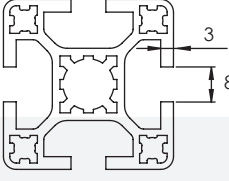
Type	Order No.	fits KLKB   KLB	compatible with	PU
<b>Holder for hook-and-loop fastener for item (6 mm groove)</b>				
	KBH-R 12 I G6 Holder for hook-and-loop fastener, pluggable	61061 61061.9005	KLKB 200 x 13 KLB 10 KLB 15	item with 6 mm groove 10 50
	KBH-R 24 I G6 Holder for hook-and-loop fastener, pluggable	61062 61062.9005	KLKB 200 x 13 KLB 10 KLB 15 KLB 20	item with 6 mm groove 10 50
	KBH-R 36-1 I G6 Holder for hook-and-loop fastener, pluggable	61063 61063.9005	KLKB 300 x 17 KLB 15 KLB 20 KLB 25	item with 6 mm groove 10 50
<b>Holder for hook-and-loop fastener for Maytec</b>				
	KBH-R 12 May-G8 Holder for hook-and-loop fastener, pluggable	61065 61065.9005	KLKB 200 x 13 KLB 10 KLB 15	Maytec PG40 with 8 mm groove 10 50
	KBH-R 24 May-G8 Holder for hook-and-loop fastener, pluggable	61066 61066.9005	KLKB 200 x 13 KLB 10 KLB 15 KLB 20	Maytec PG40 with 8 mm groove 10 50
	KBH-R 36-1 May-G8 Holder for hook-and-loop fastener, pluggable	61067 61067.9005	KLKB 300 x 17 KLB 15 KLB 20 KLB 25	Maytec PG40 with 8 mm groove 10 50

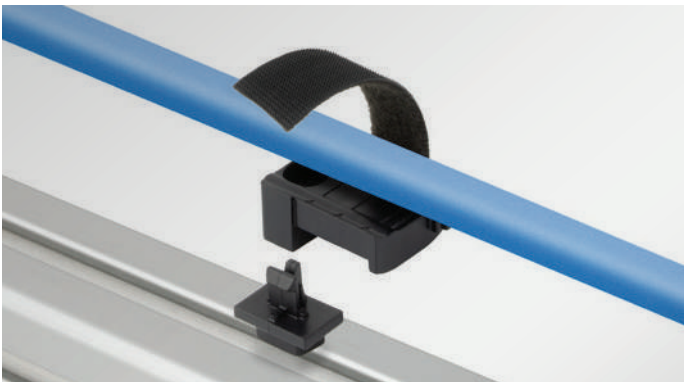

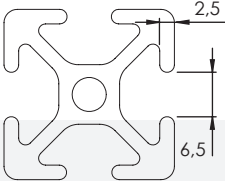
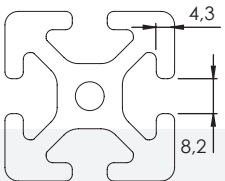

Type	Order No.	fits KLKB   KLB	compatible with	PU	
<b>Holder for hook-and-loop fastener for profile 80/20 series 25</b>					
	KBH-R 12 P80/20-25 Holder for hook-and-loop fastener, pluggable	61084 61084.9005	KLKB 200 x 13 KLB 10 KLB 15	Profile 80/20 series 25	10 50
	KBH-R 24 P80/20-25 Holder for hook-and-loop fastener, pluggable	61085 61085.9005	KLKB 200 x 13 KLB 10 KLB 15 KLB 20	Profile 80/20 series 25	10 50
	KBH-R 36-1 P80/20-25 Holder for hook-and-loop fastener, pluggable	61086 61086.9005	KLKB 300 x 17 KLB 15 KLB 20 KLB 25	Profile 80/20 series 25	10 50
<b>Holder for hook-and-loop fastener for profile 80/20 series 40</b>					
	KBH-R 12 P80/20-40 Holder for hook-and-loop fastener, pluggable	61088 61088.9005	KLKB 200 x 13 KLB 10 KLB 15	Profile 80/20 series 40	10 50
	KBH-R 24 P80/20-40 Holder for hook-and-loop fastener, pluggable	61089 61089.9005	KLKB 200 x 13 KLB 10 KLB 15 KLB 20	Profile 80/20 series 40	10 50
	KBH-R 36-1 P80/20-40 Holder for hook-and-loop fastener, pluggable	61090 61090.9005	KLKB 300 x 17 KLB 15 KLB 20 KLB 25	Profile 80/20 series 40	10 50

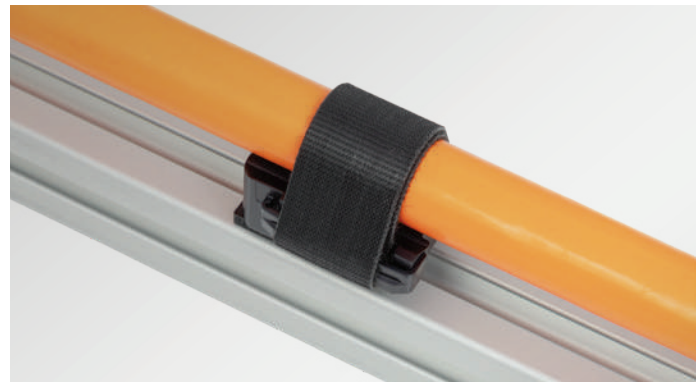
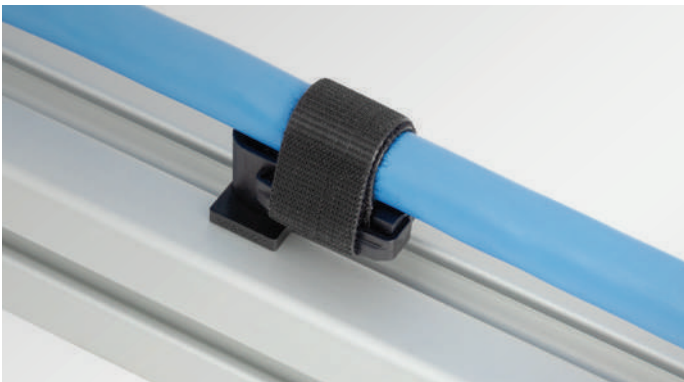

3  
3.1  
3.2  
3.3

# KBH-R

## Holders for hook-and-loop cable ties



Type	Order No.	fits KLKB   KLB	compatible with	PU
<b>Holder for hook-and-loop fastener for assembly on 35 mm top hat DIN rails</b>				
	KBH-R 12-SF-M4 Holder for hook-and-loop fastener, pluggable	61068  61068.9005	KLKB 200 x 13 KLB 10 KLB 15	35 mm top hat DIN rails  10  50
	KBH-R 24-SF-M4 Holder for hook-and-loop fastener, pluggable	61069  61069.9005	KLKB 200 x 13 KLB 10 KLB 15 KLB 20	35 mm top hat DIN rails  10  50
<b>Holder for hook-and-loop fastener for assembly on C-rails</b>				
	KBH-R 12-SC Holder for hook-and-loop fastener, pluggable	61070  61070.9005	KLKB 200 x 13 KLB 10 KLB 15	C-rails with an opening dimension of 16 mm  10  50
	KBH-R 24-SC Holder for hook-and-loop fastener, pluggable	61071  61071.9005	KLKB 200 x 13 KLB 10 KLB 15 KLB 20	C-rails with an opening dimension of 16 mm  10  50
<b>NEW</b>	KBH-R 12-C Holder for hook-and-loop fastener, pluggable	61076  61076.9005	KLKB 200 x 13 KLB 10 KLB 15	C-rails with an opening dimension of 16 mm  10  50
<b>NEW</b>	KBH-R 24-C Holder for hook-and-loop fastener, pluggable	61077  61077.9005	KLKB 200 x 13 KLB 10 KLB 15 KLB 20	C-rails with an opening dimension of 16 mm  10  50
<b>NEW</b>	KBH-R 36-C Holder for hook-and-loop fastener, pluggable	61078  61078.9005	KLKB 300 x 17 KLB 15 KLB 20 KLB 25	C-rails with an opening dimension of 16 mm  10  50

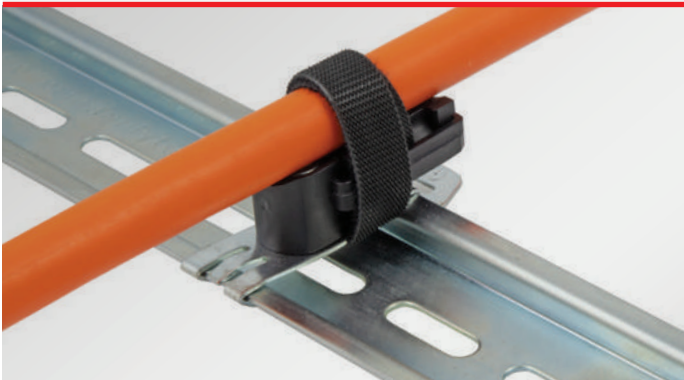

# KBH-R, KBH-KS

## Holders for hook-and-loop cable ties

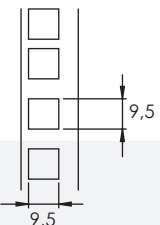
Type	Order No.	fits KLKB   KLB	compatible with	PU
<b>Holder for hook-and-loop fastener for assembly on 19" system punching</b>				
	KBH-R 12 9,5 Holder for hook-and-loop fastener, pluggable	61073	19" system punching 9,5 x 9,5 mm	10
		61073.9005		KLKB 200 x 13 KLB 10 KLB 15
	KBH-R 24 9,5 Holder for hook-and-loop fastener, pluggable	61074	19" system punching 9,5 x 9,5 mm	10
		61074.9005		KLKB 200 x 13 KLB 10 KLB 15 KLB 20
<b>Holder for hook-and-loop fastener, self-adhesive</b>				
<span style="background-color: red; color: white; padding: 2px;">NEW</span>	KBH-KS 12 Holder for hook-and-loop fastener, self-adhesive	61080	universal	10
		61080.9005		KLKB 200 x 13 KLB 10 KLB 15
<span style="background-color: red; color: white; padding: 2px;">NEW</span>	KBH-KS 24 Holder for hook-and-loop fastener, self-adhesive	61081	universal	10
		61081.9005		KLKB 200 x 13 KLB 10 KLB 15 KLB 20
<span style="background-color: red; color: white; padding: 2px;">NEW</span>	KBH-KS 36-1 Holder for hook-and-loop fastener, self-adhesive	61082	universal	10
		61082.9005		KLKB 300 x 17 KLB 15 KLB 20 KLB 25

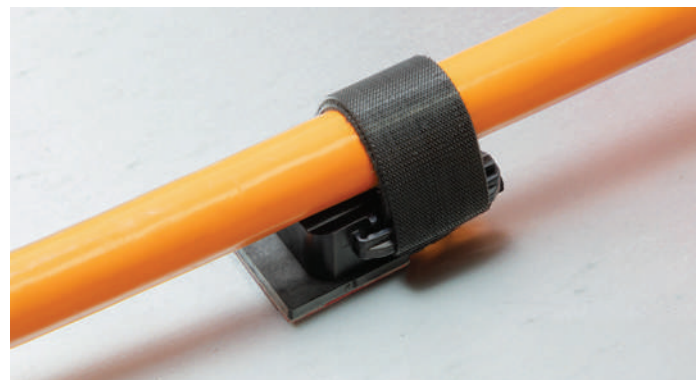

3  
3.1  
3.2  
3.3

# KBH ServiceBox

Service case with assortment of holders for hook-and-loop fasteners



## Convenient – everything available right away!

The KBH service cases are ideal for installation or maintenance work, but the range also provides useful services for new developments.

With the KBH-S and KBH-R service cases, the required holders are always available.

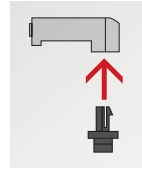

The pluggable holders for hook-and-loop fasteners are created by combining KBH-S screw-on cable plates and bases matched to the respective profile.



## KBH-S ServiceBox for assembly with screws

### Content \*

- 50× KBH-S 12 M5
- 25× KBH-S 24 M5
- 25× KBH-S 36-2 M5
- 1× KEL-DPZ 25 cable entry plate
- 1× icotek screwdriver

Order No. 88031



## KBH-R ServiceBox for Rittal punched section and punched rail

### Content \*

- 50× KBH-S 12 M5
- 30× KBH-S 24 M5
- 20× KBH-S 36-1 M5
- 100× RS MS base for Rittal punched section and punched rail
- 1× KEL-DP 32 cable entry plate
- 1× QVT 20 cable gland
- 1× icotek screwdriver

Order No. 88032



## KBH-R ServiceBox for MiniTec and item profiles with 8 mm groove

### Content \*

- 40× KBH-S 12 M5
- 20× KBH-S 24 M5
- 30× KBH-S 36-1 M5
- 90× RS M-I G8 base for MiniTec and item profiles with 8 mm groove
- 1× KEL-DP 20 cable entry plate
- 1× icotek screwdriver

Order No. 88033

# KBH ServiceBox

Service case with assortment of holders for hook-and-loop fasteners



## KBH-R ServiceBox

for BoschRexroth profiles with 8 mm groove

### Content \*

- 30× KBH-S 12 M5
- 30× KBH-S 24 M5
- 20× KBH-S 36-1 M5
- 80× RS B-R G8 base for BoschRexroth profiles with 8 mm groove
- 1× KEL-SCDP-TR 32 cable entry plate
- 1× icotek screwdriver

Order No. 88034



## KBH-R ServiceBox

for item profiles with 6 mm groove

### Content \*

- 40× KBH-S 12 M5
- 20× KBH-S 24 M5
- 30× KBH-S 36-1 M5
- 90× RS item G6 base for item profiles with 6 mm groove
- 1× KEL-DPZ 25|4 grey cable entry plate
- 1× icotek screwdriver

Order No. 88035



## KBH-R ServiceBox

for MayTec profiles with 8 mm groove

### Content \*

- 40× KBH-S 12 M5
- 20× KBH-S 24 M5
- 30× KBH-S 36-1 M5
- 90× MT G8.3 base for MayTec PG40 profiles with 8 mm groove
- 1× KEL-DPZ 25|4 grey cable entry plate
- 1× icotek screwdriver

Order No. 88036



## KBH-R ServiceBox

for 19" system punching

### Content \*

- 50× KBH-S 12 M5
- 30× KBH-S 24 M5
- 100× RS R G9.5 base for 19" system punching 9,5 × 9,5 mm
- 1× KEL-DP 32|7 grey cable entry plate
- 1× QVT 20 cable gland, QT 4
- 1× icotek screwdriver

Order No. 88037

3  
3.1  
3.2  
3.3

# KBH

## Holders for hook-and-loop cable ties

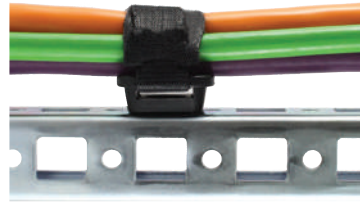

These holders can be used in combination with cable ties with hook-and-loop fastener KLKB and hook-and-loop tape KLB.

Large variety of holders provides unique and numerous mounting possibilities.

The KBH-R hook-and-loop tape holder is particularly suitable for tool-free mounting in the VX25 enclosure from Rittal.

### Advantages & benefits

- Assembly within seconds
- Secure hold
- Flexible usage

### Specifications KBH-S, KBH-R, KBH-R-TX

Material	Polyamide (PA)
Colour	■ black
Flame class	UL 94 V-0, self-extinguishing
Temperature	-40°C to +140°C
Properties	Halogen-free, silicone-free

### Specifications KBH-SB, KBH-RBA

Material	Polyamide (PA)
Colour	■ black (KBH-SB) □ nc (KBH-RBA)
Flame class	UL 94 V-2
Temperature	-40°C to +85°C (short-term to 110°C)

### Specifications KBH-RBB

Material	Polyamide (PA)
Colour	■ black
Temperature	-40°C to +120°C

### Compatible with

KLKB/KLB Cable ties with hook-and-loop fastener 215

Description	Type	Order No.	fits KLKB   KLB	compatible with	PU
<b>Holder for hook-and-loop fastener, screwable</b>					
	KBH-S	■ 61019	KLKB 200 × 7 KLKB 200 × 13 KLB 10 Cable ties up to 12 mm width	23 × 23 mm mounting rail	100
	KBH-SB	■ 61002	KLKB 200 × 7	universal	100
<b>Holder for hook-and-loop fastener, pluggable</b>					
	KBH-R	■ 61018	KLKB 200 × 7 KLKB 200 × 13 KLB 10 Cable ties up to 12 mm width	23 × 23 mm mounting rail systems for Rittal VX25	100
	<b>NEW</b> KBH-R-TX	■ 61005	KLKB 200 × 7 KLKB 200 × 13 KLB 10 Cable ties up to 12 mm width	Telex rail	100
	KBH-RBA nc	□ 61003	KLKB 200 × 7	drill-hole ø 6 mm	100
	KBH-RBB	■ 61004	KLKB 200 × 7	drill-hole ø 6.5 mm	100



Telex rail

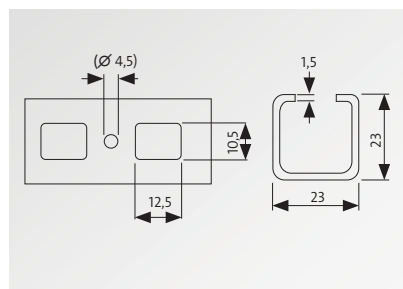

23 × 23 mm mounting rail

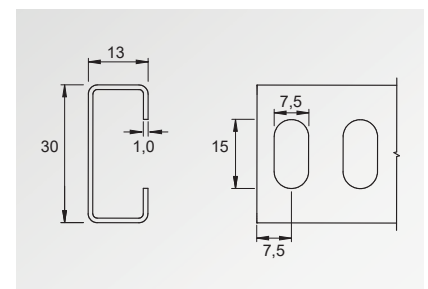

Telex rail



Cable ties with hook-and-loop fasteners are a more and more common fixing mode for cables. They are used instead of standard cable ties, because they can be easily closed and opened several times. The soft material is gentle on cables, especially where vibrations are present.

Hook-and-loop cable ties are available individually (KLKB) in four different sizes or as a continuous roll (KLB) in four different sizes.

**Advantages & benefits**

- Reusable
- Adaptable
- The cable tie material is gentle on cables, especially if there are vibrations

**Specifications**

Material	Polypropylene + Velours PA
Colour	black
Temperature	-30°C to +80°C

**Accessories**

KBH Holder for hook-and-loop fastener      205 - 211

Type	Size [mm]			Order No.	PU
	L	W1	W2		
KLKB 200 × 7 bk (PU 100 = 1 reel)	200	13	7	61021	100
KLKB 200 × 7 bk on reel (750 pcs.)	200	13	7	61025	1
KLKB 200 × 13 bk (PU 100 = 1 reel)	200	20	13	61022	100
KLKB 200 × 13 bk on reel (750 pcs.)	200	20	13	61026	1
KLKB 230 × 13 bk (PU 100 = 1 reel)	230	20	13	61023	100
KLKB 230 × 13 bk on reel (650 pcs.)	230	20	13	61027	1
KLKB 300 × 17 bk (PU 100 = 1 reel)	300	25	17	61024	100
KLKB 300 × 17 bk on reel (500 pcs.)	300	25	17	61028	1
KLKB 10 bk			10	61011	25 m
KLKB 15 bk			15	61012	25 m
KLKB 20 bk			20	61013	25 m
KLKB 25 bk			25	61014	25 m

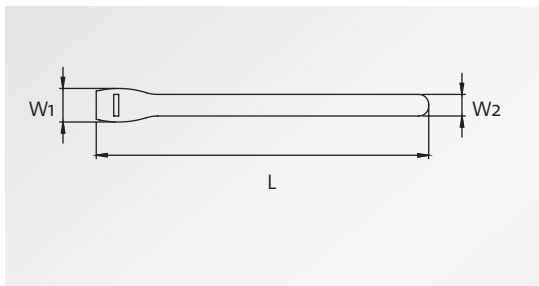

3  
3.1  
3.2  
3.3

### 3.3 MSMC Modular stackable cable clamp



The modular stackable cable clamp MSMC is used for easy, quick and secure fastening of cables, pipes and other cylindrical components. The great advantage of this cable clamp is that it can be easily extended by stacking or lining up.

By using the CMC30 connector, different clamping areas can be connected to each other. The MSMC offers a very high level of corrosion protection thanks to the choice of materials for the cable clamps and screws.

The diameter of the cables can vary up to 16 mm  
Suitable for large cable diameters up to 55 mm

Designed for high strain relief

Suitable for large bending radii of rigid cables

Several cable clamps can be strung together with

Simple expansion by lining up or stacking

Assembly on surfaces or on the C-rail

MSMC

Markings on the half shells indicate how to fit.  
short at the bottom – short at the top:  
» Mounting in line  
short at the bottom – long at the top:  
» Mounting in height

Ridges in the half shells enable the absorption of tensile and torsional forces

Mounting at a central point, the slotted hole offers flexibility during assembly

Anti-rotation lock during assembly with two through bolts





Modular stackable cable clamp  
for cable diameters 10 – 32 mm

MSMC

219



Modular stackable cable clamp  
for cable diameters 30 – 55 mm

MSMC

219

## Assembly – lining up and stacking

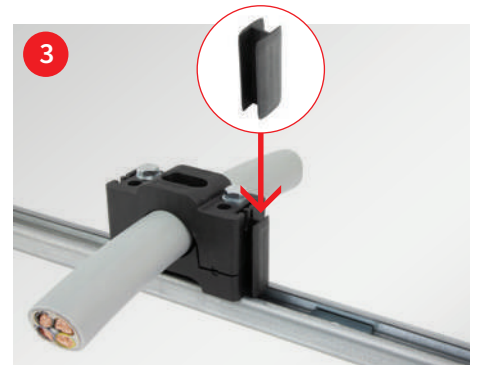
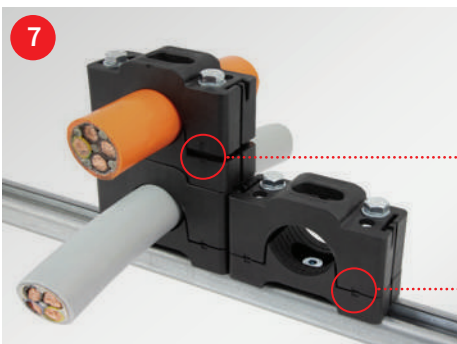

The great advantage of this cable clamp is that it can be easily extended by stacking or lining up. With Set B and a coupler, any number of cable clamps can be arranged in a row; with Set A, the cable clamps can also be stacked by rotating the top section by 180°.

3  
3.1  
3.2  
3.3

# MSMC

## Modular stackable cable clamp



The modular stackable cable clamp MSMC is used for easy, quick and secure fastening of cables, pipes and other cylindrical components. The variable clamping range is up to 16 mm.

**The great advantage of this cable clamp is that it can be easily extended by stacking or lining up. By using the CMC30 coupler, different clamping areas can be connected to each other. The MSMC offers a very high level of corrosion protection thanks to the choice of materials for the cable clamps and screws.**

The cable clamp consists of an upper and a lower part as well as hexagon head screws. A coupler is used to easily connect several cable clamps together horizontally. The longitudinal and transverse ridges of the support surface serve to absorb torsional and tensile forces. The central mounting point (slotted hole) offers a high degree of flexibility on many surfaces. For even greater stability and torsion resistance, two long screws can be used for fastening.

The cable clamps are available as Set A for lining up and stacking or as Set B for lining up. Set B contains a cable clamp (upper and lower part), a coupler and two short hexagon head screws. Set A additionally contains two long hexagon head screws.

The cable clamp can be combined with a sliding nut for optional assembly on the C-rail.

### Advantages

- Several cable clamps can be lined up or stacked together
- The diameter of the cables can vary up to 16 mm
- Designed for high strain relief
- Suitable for large cable diameters up to 55 mm
- Suitable for large bending radii of rigid cables
- Assembly on surfaces or on the C-rail
- Ridges in the half shells enable the absorption of tensile and torsional forces
- Anti-rotation lock during assembly with two through bolts
- The coupler can be used as a mounting aid for overhead mounting
- Weather-resistant material

### Specifications

Material	Polyamide (PA)
Colour	black
Flame class	UL 94 V-0, self-extinguishing
Temperature	-40°C to +140°C (static)
Properties	Halogen free, silicon free

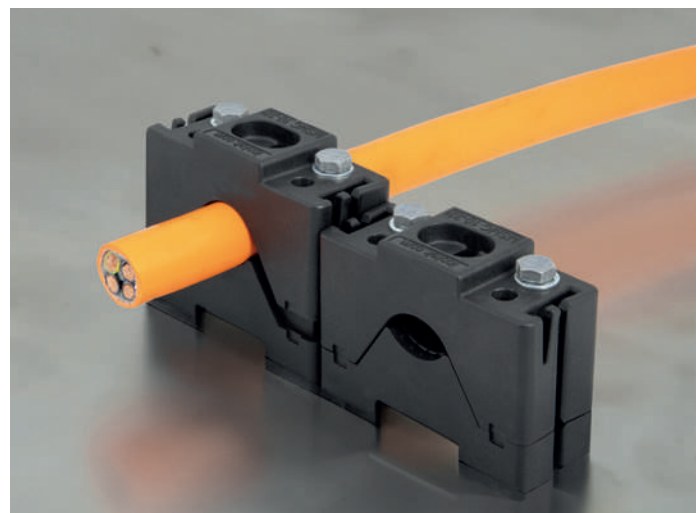
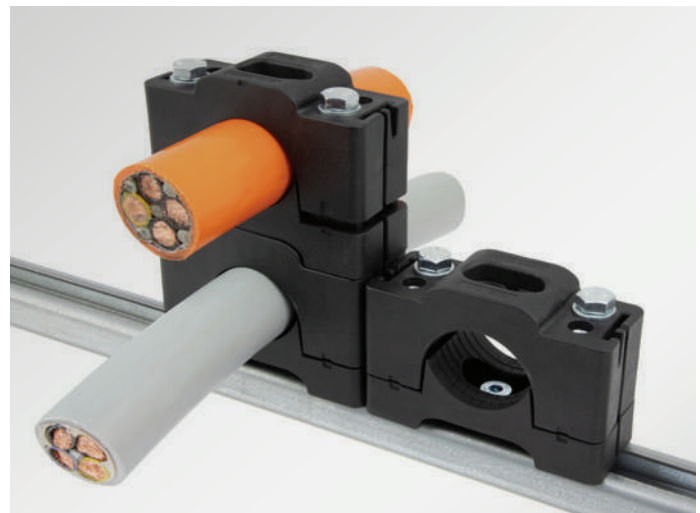

# MSMC

## Modular stackable cable clamp



Description	Type	Clamping range	Dimensions Length x Width x Height	Order No.	PU
Cable clamp Set A 10-22	MSMC 10-22   Set A	10 – 22 mm	64 x 26 x 47 mm	32400	5
Cable clamp Set B 10-22	MSMC 10-22   Set B	10 – 22 mm	64 x 26 x 47 mm	32401	5
Cable clamp Set A 20-32	MSMC 20-32   Set A	20 – 32 mm	64 x 26 x 47 mm	32410	5
Cable clamp Set B 20-32	MSMC 20-32   Set B	20 – 32 mm	64 x 26 x 47 mm	32411	5
Cable clamp Set A 30-46	MSMC 30-46   Set A	30 – 46 mm	100 x 40 x 64,5 mm	32420	5
Cable clamp Set B 30-46	MSMC 30-46   Set B	30 – 46 mm	100 x 40 x 64,5 mm	32421	5
Cable clamp Set A 44-55	MSMC 44-55   Set A	44 – 55 mm	100 x 40 x 72,5 mm	32430	5
Cable clamp Set B 44-55	MSMC 44-55   Set B	44 – 55 mm	100 x 40 x 72,5 mm	32431	5
Coupler for cable clamp small 10-22, 20-32	CMC 10	–	35 x 13,4 x 12 mm	32598	10
Coupler for cable clamp large 30-46, 44-55	CMC 30	–	50 x 20 x 15 mm	32599	10
Sliding nut for C-rail for cable clamp small 10-22, 20-32 including M5 hexagon head screw	SCMC 10	–	40 x 28 x 6,5 mm	32596	5
Sliding nut for C-rail for cable clamp large 30-46, 44-55 including M8 hexagon head screw	SCMC 30	–	40 x 28 x 6,5 mm	32597	5

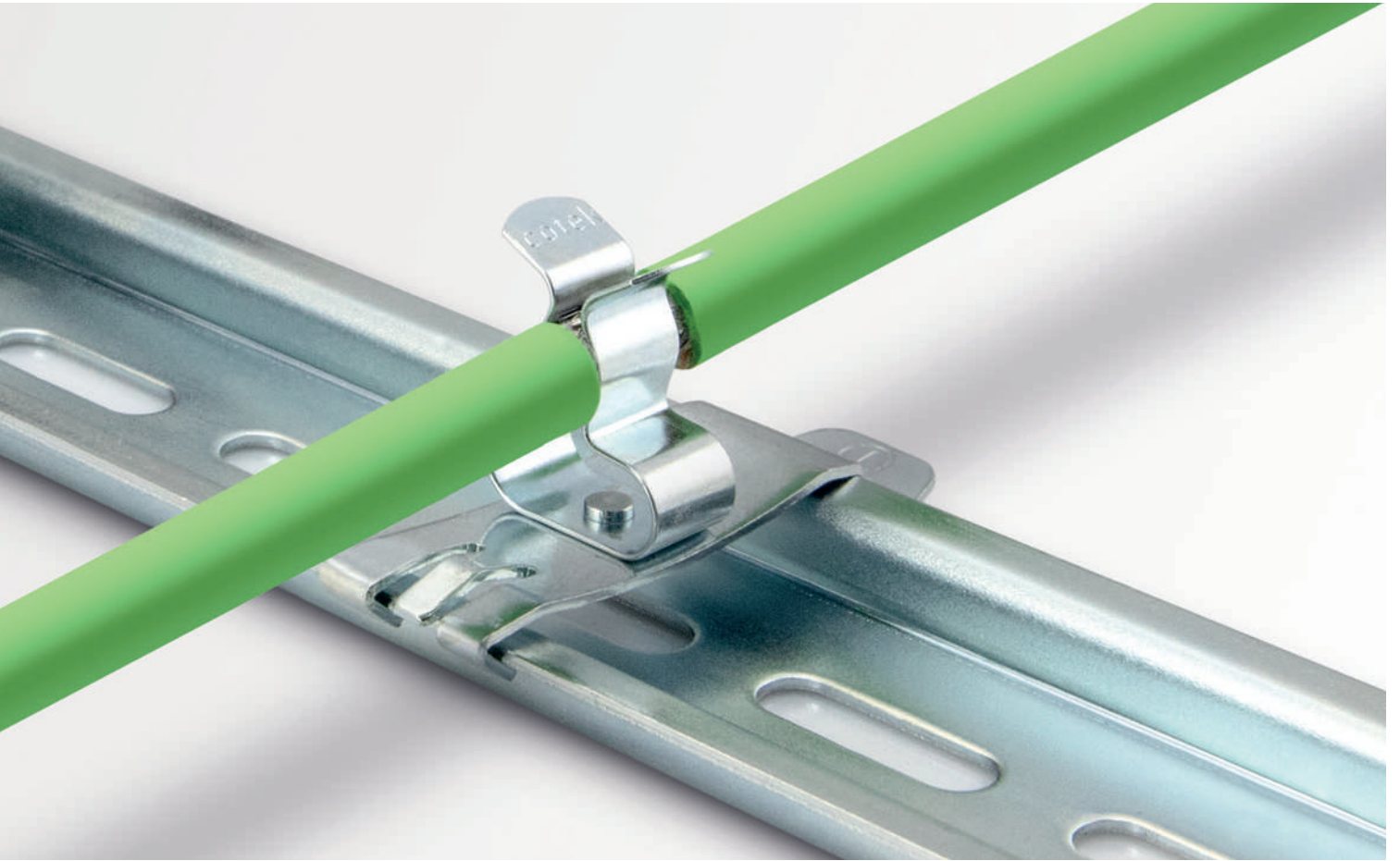

# EMC solutions

## Shield clamps and cable entry systems

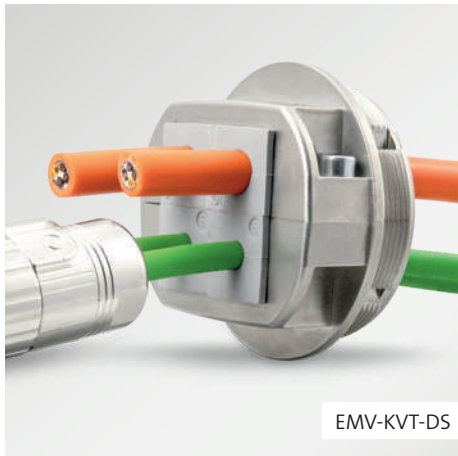
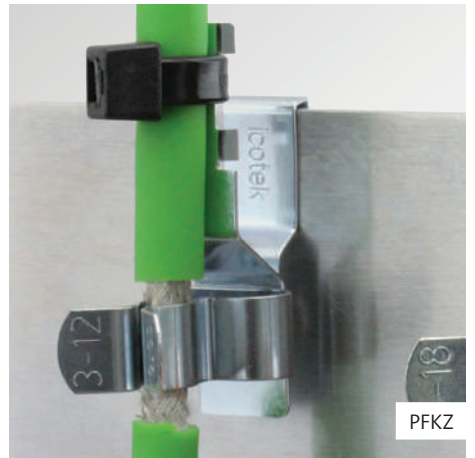
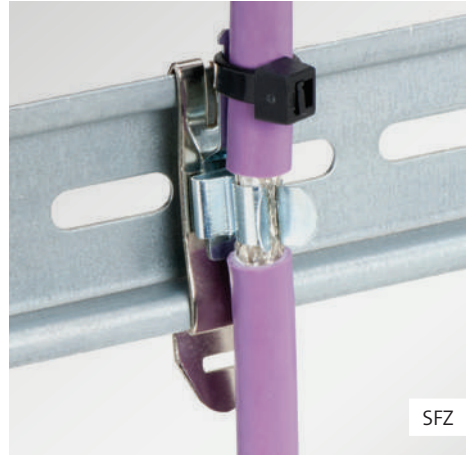

EMC solutions  
Shield clamps and cable entry systems

4
4.1
4.2
4.3
4.4

## 4 EMC solutions

### Shield clamps and cable entry systems



**The icotek EMC shield clamps are characterised by excellent dissipation of high-frequency interference and efficient EMC shielding for cables from 1.5 to 75 mm diameter.**

For process measurement and control equipment, an increasingly higher level of protection against failure is required. Earthing of the cable shields is very important. The area where the cable shield is connected to the enclosure earth is a critical point. It is very important that the connection has a low resistance.

icotek EMC products therefore provide a good solution. The SKL shield clamps offer a large contact area to the cable shield. In comparison to conventional shield brackets and up to 50% higher contact area can be achieved when using the SKL line. The specified clamping range can be exceeded up to 10%.

In high frequency fields, the SKL shield clamps provide a low resistance. The effective range is up to 1,000 MHz below 120 Ohms and 10 kHz to 100 MHz significant below 20 Ohms.

In case of conducted as well as field bound EMI disturbances, our split cable entry system EMC-KEL-DS and our split cable gland EMC-KVT-DS offer an effective way to divert and block those disturbances and provides an alternative to conventional EMC cable glands.



4  
4.1  
4.2  
4.3  
4.4

Product range shield clamps	Mounting type	Strain relief available	Multi shield clamps	Page
MSKL / SKL	for screw mounting, riveting	●	–	229 – 231
LF	for screw mounting	●	–	232 – 234
SF	for 35 mm top hat DIN rails	●	–	235 – 237
PFS	for bus bars	●	●	238 – 241
SC	for C-rails	●	–	242 – 245
PFK	pluggable	●	●	246 – 249
PCB	for printed circuit boards	–	–	250
STFZ	for decentralised bus modules	●	●	251 – 253
RLF	Row solutions	●	●	256 – 259

Product range EMC cable entry frames	IP55	Strain relief	Cable Ø mm min   max	For max. no. of cables	Page
EMC-KEL-DS	●	●	1 – 35	40	274 – 275
EMC-KVT-DS	●	●	1 – 35	16	278 – 279
EMC-KEL-U	–	–	1 – 35	40	276 – 277

## 4.1 EMC cable shield earthing

### Shield clamps and earthing components

**MSKL type with large clamping range**

**Large contact area to the cable shield. Shield and cable strands will not be squeezed**

**Available in various sizes**

**High cable density possible**

**Vibration resistance and twist protection due to solid rivets**

**Wide variety in mounting types: top hat DIN rail/C-rail snap mount, screw mount**

**Do not use the shield connection as a strain relief location!**

**Secure hold for cable ties and cables, strain relief acc. to EN 62444**

**A:**  **Figure A: SKL-line**

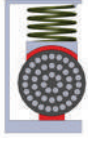
**B:**  **Figure B: Conventional systems**



### EMC shield clamps MSKL

Due to its special design, the clamping ranges of the MSKL are very large while the dimensions are comparatively small. (Example: MSKL 3-12, assembled with a 12 mm cable shield: width 26.25 mm).

### Advantages & benefits

- Large clamping areas, therefore less product sizes needed to cover a large cable diameter range
- Space-saving design, even when fully assembled
- Partially with integrated strain relief
- Large cable shield contact area
- Easy assembly
- The spring design requires no adjustments and will permanently maintain contact to the cable shield
- Shock and vibration resistant, maintenance free



More information about the connection between the cable shield and the equipotential bonding bar in PROFINET applications:  
[www.icotek.com/en/profinet](http://www.icotek.com/en/profinet)

\* Shield connections are not certifiable as components according to the requirements of the directive and the standards for electrical equipment in potentially explosive atmospheres. Thus, the use of the shield connections in hazardous areas is possible even without a corresponding approval and marking.



## Assembly possibilities

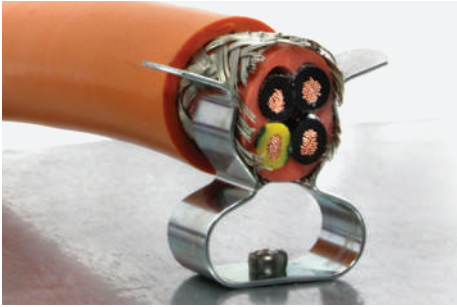

Assembly with rivets

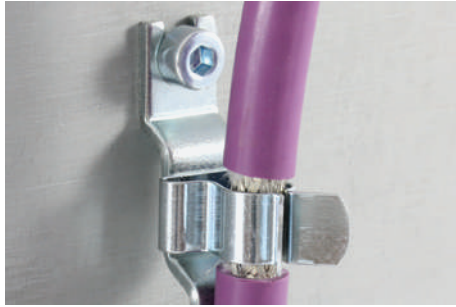

Assembly with screws



Assembly on 35 mm top hat DIN rails



Assembly on 10 × 3 mm bus bars



Assembly on 30 mm C-rails



Assembly by clamping onto sheet edges

## Advantages of solid rivets



- Vibration resistance according to EN 61373
- Twist protection due to solid rivets
- Stronger contact pressure of the riveted parts

## SKL | MSKL | SKZ clamping ranges

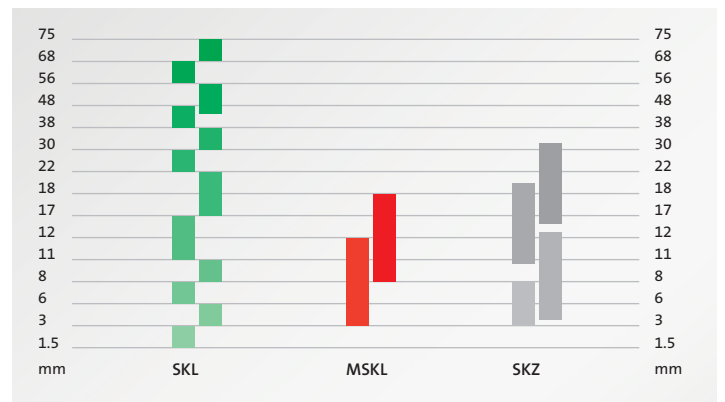

4  
4.1  
4.2  
4.3  
4.4

## 4.1 EMC cable shield earthing

### Shield clamps and earthing components



EMC shield clamps  
for assembly with rivets/with screws  
with/without strain relief function

MSKL, SKL, RCL|MSKL, RCL|SKL, RCLZ|MSKL,  
MB+MSKL/SKL

229 – 231



EMC shield clamps  
for assembly with screws  
with/without strain relief function

LFZ-M|MSKL, LFZ|SKL, LFZ-U|SKL, LFZ-U-AB,  
LFZ-M(45°)|MSKL, LFZ-M(90°)|MSKL, LF2Z-  
M|SKL, SKZ, LF|MSKL, LF|SKL, SK

232 – 234



EMC shield clamps  
for 35 mm top hat DIN rails  
with/without strain relief function

SFZ-M|MSKL, SFZ|SKL, SF2Z-M|MSKL,  
SF2Z|SKL, SF|SKZ, SF-M|MSKL, SF|SKL,  
SFS|SKL, SF|SK

236 – 237



EMC shield clamps  
for 10 × 3 mm bus bars  
with/without strain relief function,  
single and double

PFSZ-M|MSKL, PFSZ|SKL, PFS2Z-M|MSKL,  
PFS2Z|SKL, SS|SKZ, PFS|SKL, PFS|SCL, SS|SK,  
SKS, PFS2Z|SKL, PFS2|SKL

238 – 241



EMC shield clamps  
for 30 mm C-rails  
with/without strain relief function

SC|LFZ-M|MSKL, SC|LFZ|SKL, SC|LF2Z-M|M-  
SKL, SC|SKZ, SC|LF|MSKL, SC|LF|SKL, SC|SK,  
LFC, CC-LFC

242 – 245



EMC shield clamps  
for assembly on sheet edges  
with/without strain relief function,  
single and double

PFKZ-M|MSKL, PFKZ|SKL, PFK|SKL,  
PFK2Z|SKL, PFK2|SKL

246 – 249



Shield clamps  
for printed circuit boards

PCB|SKL

250

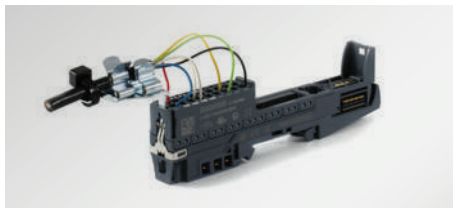

Shield clamps  
for decentralised bus modules

STFZ|SKL / STFZ2|SKL / STFZ-U|SKL /  
STFZ-SP|SKL / STFZ2-SP|SKL

251 – 253



Assortment of SKL shield clamps

EMC ServiceBox multi  
EMC ServiceBox

254 – 255

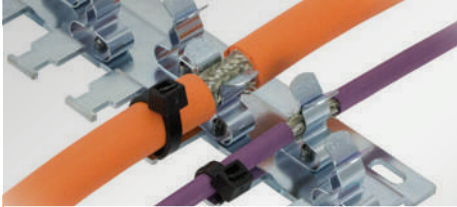

**EMC Shield clamp assemblies**

RLFZ(-M) - clamp assembly for screw mount  
 SC|RLFZ(-M) - clamp assembly for C-rails  
 SF|RLFZ - clamp assembly for top hat rails  
 RLF - clamp assembly without strain relief

256 – 259



**EMC cable assemblies**  
 as accessories for cable entry components  
 with/without strain relief function

KEL-EMC-Z / KEL-EMC-PF / KEL-EMC /  
 KVT-EMC

260 – 263



**EMC strain relief plates**  
 various mounting types

KAFM

264 – 265



**Earthing tapes**  
 for assembly with screws

MB

266 – 268



**EMC Split cable entry frames**  
 for cable diameters up to 35 mm

EMC-KEL-DS

274 – 275



**EMC Split cable gland**  
 for screw-on assembly with a locknut  
 M32, M63  
 for cable diameters up to 35 mm

EMC-KVT-DS

278 – 279

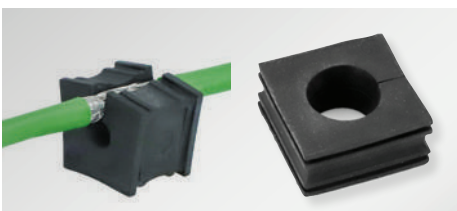

**Split EMC grommets**  
 for cables with and without connectors  
 for cable diameters 2 to 33 mm

EMC-KT

280 – 281

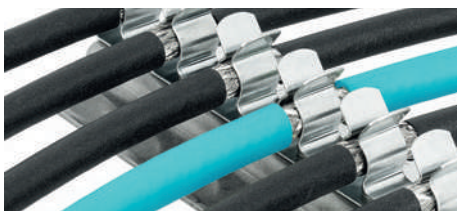

**EMC Configurator**  
[www.icotek.com/emc](http://www.icotek.com/emc)

4  
 4.1  
 4.2  
 4.3  
 4.4

# EMC

## Test results

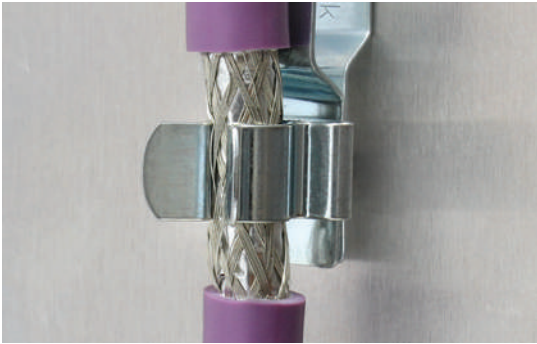

### Leakage and Impedance

All icotek shield clamps have been tested utilising various frequency ranges and in all tests there was minimal leakage resistance.

icotek EMC shield clamps are proven to absorb electromagnetic interferences.

Electrical impedance values:

- from 10 kHz to 100 MHz under 20 Ohm
- up to 1.000 MHz under 120 Ohm

The unique design of icotek shield clamps effectively reduce high frequency interferences.

### Contact area

The SKL shield clamps offer a large contact area to the cable shield (see figure A).

In comparison to conventional shield clamps, an up to 50% higher contact area is achieved when using the SKL product line.



Figure A: SKL-line

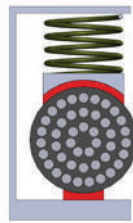
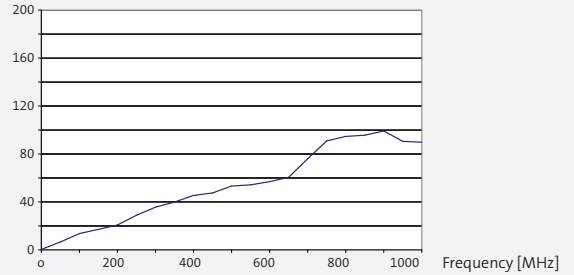

Figure B: Conventional systems

### LF|SKL 8-11

Impedance Z [Ohm]



Leakage absorption [dB]

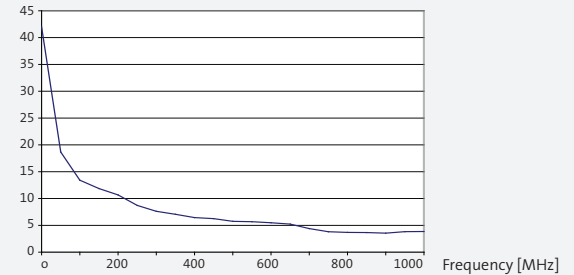

### SF|SKL 6-8

Impedance Z [Ohm]

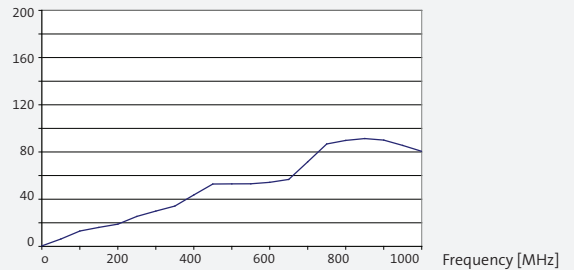

Leakage absorption [dB]

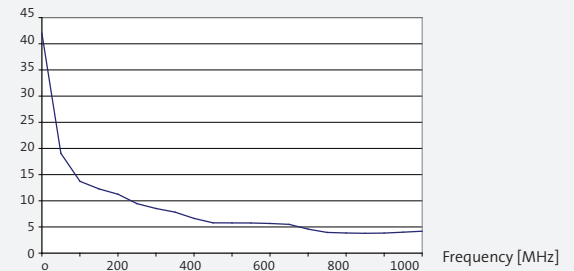

# EMC shield clamps for assembly with rivets



MSKL

Whenever a cable shielding is required with the possibility of grounding, EMC shield clamps can be used. Shield clamps are easy to use and effective in dissipating conducted disturbances.

Due to its special design, the clamping ranges of the MSKL are very large while the dimensions are comparatively small. (Example: MSKL 3-12, assembled with a 12 mm cable shield: width 26.25 mm).

### Assembly

The shield clamps can be mounted using rivets.

### Advantages & benefits

- Large clamping areas, therefore less product sizes needed to cover a large cable diameter range
- Space-saving design, even when fully assembled
- Partially with integrated strain relief
- Large cable shield contact area
- Easy assembly
- The spring design requires no adjustments and will permanently maintain contact to the cable shield
- Shock and vibration resistant, maintenance free

### Specifications

#### Material

MSKL clamp, SK clamp	Spring steel, galvanised
** SKL 30–38 mm, SKL 38–48 mm	Stainless steel



	MSKL single	SKL single	
Clamping range	Order No.	Order No.	
MSKL	3 – 12 mm	37600	–
	8 – 18 mm	37602	–
SKL	1.5 – 3 mm	–	36200
	3 – 6 mm	–	36202
	6 – 8 mm	–	36204
	8 – 11 mm	–	36205
	11 – 17 mm	–	36206
	17 – 22 mm	–	36207
	22 – 30 mm	–	36208
	30 – 38 mm **	–	36209 *
	38 – 48 mm **	–	36213 *
	44 – 56 mm	–	36216 *
	56 – 68 mm	–	36217 *
	68 – 75 mm	–	36218 *
	PU	50	50   * 5

### SKL | MSKL | SKZ clamping ranges

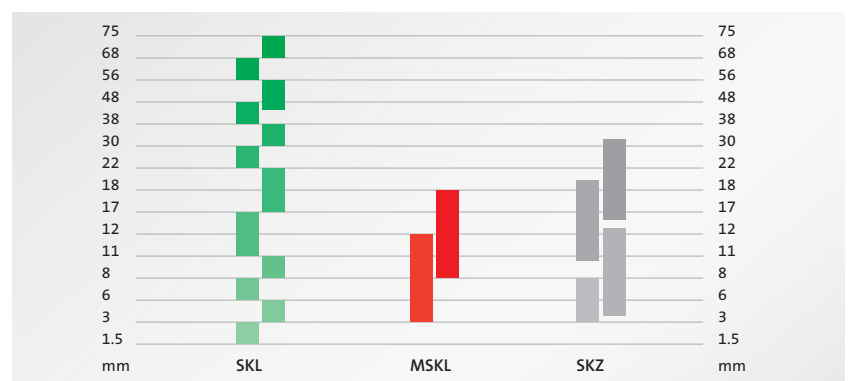

4  
4.1  
4.2  
4.3  
4.4

# EMC shield clamps on cable lugs for assembly with rivets

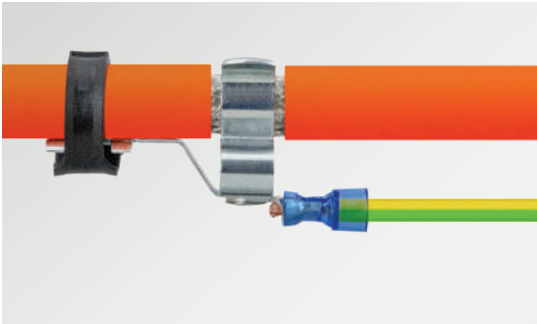

Whenever a cable shielding is required with the possibility of grounding, EMC shield clamps can be used. Shield clamps are easy to use and effective in dissipating conducted disturbances.

### Assembly

The shield clamps can be mounted using rivets.

### Advantages & benefits

- Integrated strain relief function
- Large contact area
- Simple and tool-free mounting, easy assembly
- The spring design requires no adjustments and will permanently maintain contact to the cable shield
- Shock and vibration resistant, maintenance free
- Designed for high density applications

### Specifications

#### Material

MSKL clamp, SK clamp      Spring steel, galvanised  
Cable lug                      UL listed

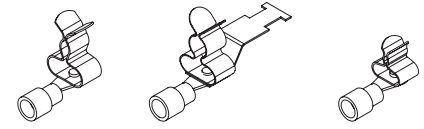

		RCL	RCL MSKL	RCLZ MSKL with cable fixation	RCL SKL
	Clamping range	RCL	Order No.	Order No.	Order No.
MSKL	3 – 12 mm	0.5 – 1.5 mm <sup>2</sup>	36296.2	36301.2	–
	3 – 12 mm	1.0 – 2.5 mm <sup>2</sup>	36297.2	36302.2	–
	3 – 12 mm	4 – 6 mm <sup>2</sup>	36298.2	36303.2	–
SKL	1.5 – 3 mm	0.5 – 1.5 mm <sup>2</sup>	–	–	36296.1
	1.5 – 3 mm	1.0 – 2.5 mm <sup>2</sup>	–	–	36297.1
	1.5 – 3 mm	4 – 6 mm <sup>2</sup>	–	–	36298.1
	3 – 6 mm	1.0 – 2.5 mm <sup>2</sup>	–	–	36297.3
	6 – 8 mm	1.0 – 2.5 mm <sup>2</sup>	–	–	36297.4
	8 – 11 mm	1.0 – 2.5 mm <sup>2</sup>	–	–	36297.5
PU			25	25	25



Applications in which both cable shields must be brought to the same potential

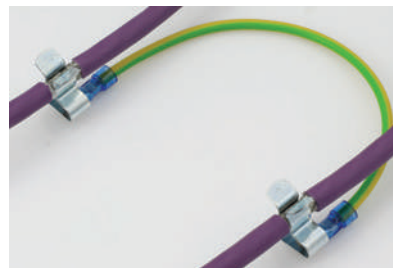

Example for an application with RCL|MSKL 3-12

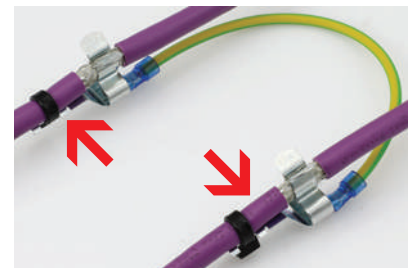

Example for an application with RCLZ|MSKL 3-12. The contacted electrical cables are also fixed.

# MB|MSKL

## Earthing tapes with fitted shield clamps with/without cable fixation



The earthing tapes are fitted with a shield clamp at one end. This solution is used where space is limited.

The earthing tapes are available with M4 or M6 holes.

### Advantages & benefits

- Very flexible assembly
- Installation even in places that are difficult to access
- Earthing tapes with pressed-on connecting end pads
- Standard products, short delivery times
- UL listed earthing tapes

### Specifications

Material Earthing tape:  
Copper tin-plated  
with pressed-on connecting end pads  
Shield clamp MSKL: Spring steel galvanised

Type	Order No.	Length L [mm]	Cross-section mm <sup>2</sup>	Hole size	Clamping range [mm]	PU
<b>Cross-section 6 mm<sup>2</sup></b>						
MB 100   6   M4+M4   MSKL 3-12	32695.01	100	6	M4	3 – 12	10
MB 100   6   M4+M4   MSKL 8-18	32695.02	100	6	M4	8 – 18	10
MB 100   6   M4+M4   Z-MSKL 3-12*	32695.011	100	6	M4	3 – 12	10
MB 100   6   M4+M4   Z-MSKL 8-18*	32695.021	100	6	M4	8 – 18	10
MB 150   6   M4+M4   MSKL 3-12	39710.01	150	6	M4	3 – 12	10
MB 150   6   M4+M4   MSKL 8-18	39710.02	150	6	M4	8 – 18	10
MB 150   6   M4+M4   Z-MSKL 3-12*	39710.011	150	6	M4	3 – 12	10
MB 150   6   M4+M4   Z-MSKL 8-18*	39710.021	150	6	M4	8 – 18	10
MB 200   6   M4+M4   MSKL 3-12	32707.01	200	6	M4	3 – 12	10
MB 200   6   M4+M4   MSKL 8-18	32707.02	200	6	M4	8 – 18	10
MB 200   6   M4+M4   Z-MSKL 3-12*	32707.011	200	6	M4	3 – 12	10
MB 200   6   M4+M4   Z-MSKL 8-18*	32707.021	200	6	M4	8 – 18	10
<b>Cross-section 10 mm<sup>2</sup></b>						
MB 100   10   M6+M4   MSKL 3-12	39711.01	100	10	M6	3 – 12	10
MB 100   10   M6+M4   MSKL 8-18	39711.02	100	10	M6	8 – 18	10
MB 100   10   M6+M4   Z-MSKL 3-12*	39711.011	100	10	M6	3 – 12	10
MB 100   10   M6+M4   Z-MSKL 8-18*	39711.021	100	10	M6	8 – 18	10

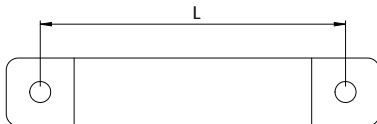

Earthing tape with shield clamp MSKL and cable fixation



Earthing tape with shield clamp MSKL

\* with cable fixation

# EMC shield clamps for assembly with screws with strain relief function



LFZ-U|SKL

Whenever a cable shielding is required with the possibility of grounding, EMC shield clamps can be used. Shield clamps are easy to use and effective in dissipating conducted disturbances.

Optional strain relief function: the cable is fixed via the cable jacket using cable ties.

Shield clamps are easily attached to mounting plates via screw. The shield clamp LFZ-U|SKL is available for M4 or M5 screws. During assembly it is sufficient to loosen the existing screw slightly to be able to slide the clamp underneath before re-tightening the screw.

### Assembly

The shield clamps can be mounted using screws, e.g. on a mounting plate.

### Advantages & benefits

- Integrated strain relief function
- Large cable shield contact area
- Easy, tool-free assembly
- The spring design requires no adjustments and will permanently maintain contact to the cable shield
- Designed for high density applications
- Shock and vibration resistant, maintenance free
- Double strain relief: acc. to PROFINET installation guidelines

### Specifications

#### Material

MSKL clamp, SKL clamp	Spring steel, zinc plated
LFZ foot	Steel, galvanically zinc plated fixing hole 4.2 mm/ 5.2 mm/6.2 mm
SK bracket	Steel, galvanically zinc plated

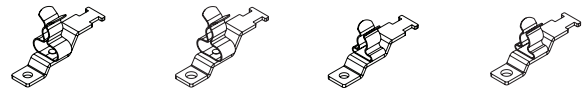

	LFZ-M MSKL Fixing hole M4	LFZ-M MSKL Fixing hole M6	LFZ SKL Fixing hole M4	LFZ SKL Fixing hole M6
	Order No.	Order No.	Order No.	Order No.
MSKL	3 – 12 mm	37612	37373	–
	8 – 18 mm	37614	37388	–
SKL	1.5 – 3 mm	–	–	36910
	3 – 6 mm	–	–	36915
	6 – 8 mm	–	–	36920
	8 – 11 mm	–	–	36925
	11 – 17 mm	–	–	36930
	17 – 22 mm	–	–	36935
	22 – 30 mm	–	–	36940
	30 – 38 mm	–	–	36941
PU	10	10	10	10



# EMC shield clamps for assembly with screws with strain relief function

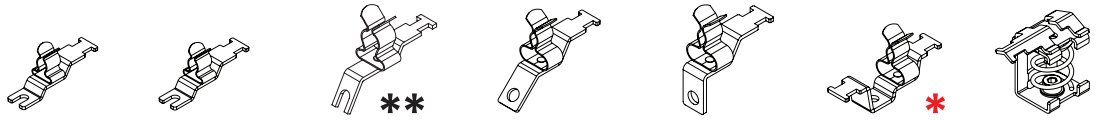

	LFZ-U SKL Fixing hole M4	LFZ-U SKL Fixing hole M5	LFZ-U-AB Fixing hole M4	LFZ-M(45°) MSKL Fixing hole M5	LFZ-M(90°) MSKL Fixing hole M5	LFZ2-M MSKL Fixing hole M4	SKZ Fixing hole M4	
Clamping range	Order No.	Order No.	Order No.	Order No.	Order No.	Order No.	Order No.	
MSKL	3 – 12 mm	–	–	–	37660.1	37661.1	37665.150	–
	8 – 18 mm	–	–	–	37660.2	37661.2	37666.150	–
SKL	1.5 – 3 mm	36886.1	36887.1	–	–	–	–	–
	3 – 6 mm	36886.2	36887.2	–	–	–	–	–
	6 – 8 mm	36886.3	36887.3	36948.3	–	–	–	–
	8 – 11 mm	36886.4	36887.4	36948.4	–	–	–	–
	11 – 17 mm	36886.5	36887.5	–	–	–	–	–
	17 – 22 mm	–	–	–	–	–	37590.150	–
	22 – 30 mm	–	–	–	–	–	37591.150	–
SK/SKZ	3 – 8 mm	–	–	–	–	–	–	36222
	4 – 13.5 mm	–	–	–	–	–	–	36224
	10 – 20 mm	–	–	–	–	–	–	–
	15 – 32 mm	–	–	–	–	–	–	–
PU	10	10	10	10	10	10	10	

\* with double strain relief function



\*\* LFZ-U-AB are especially suitable for mounting on Allen Bradley Powerflex 525/527 frequency inverters. Direct contacting on the converter saves space and interference signals are picked up directly at the interference source.

4  
4.1  
4.2  
4.3  
4.4

# EMC shield clamps for assembly with screws without strain relief function

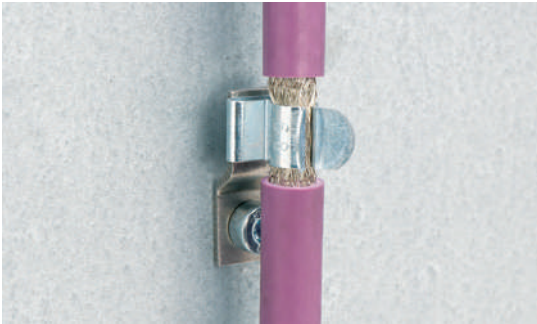

LF|SKL

Whenever a cable shielding is required with the possibility of grounding, EMC shield clamps can be used. Shield clamps are easy to use and effective in dissipating conducted disturbances.

Optional strain relief function: the cable is fixed via the cable jacket using cable ties.

Shield clamps are easily attached to mounting plates via screw. The shield clamp LFZ-U|SKL is available for M4 or M5 screws. During assembly it is sufficient to loosen the existing screw slightly to be able to slide the clamp underneath before re-tightening the screw.

### Assembly

The shield clamps can be mounted using screws, e.g. on a mounting plate.

### Advantages & benefits

- Large cable shield contact area
- Easy, tool-free assembly
- The spring design requires no adjustments and will permanently maintain contact to the cable shield
- Designed for high density applications
- Shock and vibration resistant, maintenance free

### Specifications

#### Material

MSKL clamp, SKL clamp	Spring steel, zinc plated
LF/LFZ foot	Steel, galvanically zinc plated fixing hole 4.2 mm/5.2 mm
SK bracket	Steel, galvanically zinc plated

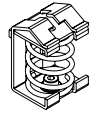

		LF MSKL Fixing hole M4	LF MSKL Fixing hole M5	LF SKL Fixing hole M4	SK Fixing hole M4
	Clamping range	Order No.	Order No.	Order No.	Order No.
MSKL	3 – 12 mm	37608	<b>NEW</b> 37374	–	–
	8 – 18 mm	37610	<b>NEW</b> 37375	–	–
SKL	1.5 – 3 mm	–	–	36251	–
	3 – 6 mm	–	–	36253	–
	6 – 8 mm	–	–	36255	–
	8 – 11 mm	–	–	36256	–
	11 – 17 mm	–	–	36257	–
	17 – 22 mm	–	–	36258	–
	22 – 30 mm	–	–	36259	–
SK/SKZ	3 – 8 mm	–	–	–	36222.002
	4 – 13.5 mm	–	–	–	36224.002
	10 – 20 mm	–	–	–	36226
	15 – 32 mm	–	–	–	36228
PU		10	10	10	10

# Mounting feet and accessories for EMC shield clamps

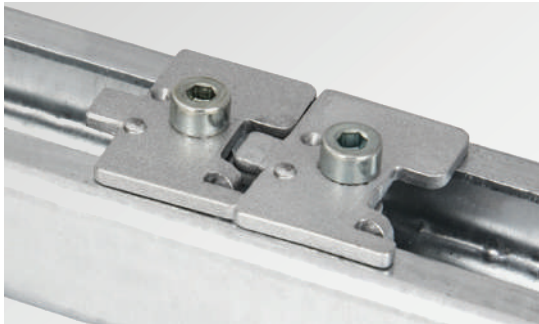

## Specifications

### Material

SF foot	Spring steel
SFS foot	Spring steel
SC foot	Sheet steel, galvanically zinc plated
Sammelschiene	Cu, tin plated, current load 140 A

## SF single | SFS single | SC single

Type	Order No.		PU
SF single M4	36230	Mounting foot, single with screw thread M4	10
SF single M5	36221	Mounting foot, single with screw thread M5	10
SFS single	36229	Mounting foot, single	10
SC single	36231	SC foot single, for 30 mm DIN-rail shape C (width of mouth: 16 mm) with twist protection notch	10
SC single	36220	SC foot single for C-rail	10



SF single



SFS single

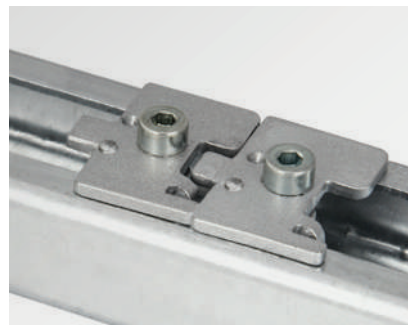

SC single 36231



SC single 36220

## Bus bar 10 × 3 mm

Type	Order No.	PU
Bus bar 10 × 3 mm	10 × 3 × 1000 mm*	36100

\* Other lengths available on request

4  
4.1  
4.2  
4.3  
4.4

# EMC shield clamps for 35 mm top hat DIN rails with strain relief function



SFZ-M|MSKL

Whenever a cable shielding is required with the possibility of grounding, EMC shield clamps can be used. Shield clamps are easy to use and effective in dissipating conducted disturbances.

Optional strain relief function: the cable is fixed via the cable jacket using cable ties.

### Assembly

The shield clamps can be mounted on 35 mm top hat DIN rails.

### Advantages & benefits

- Integrated strain relief function
- Large cable shield contact area
- Easy, tool-free assembly
- The spring design requires no adjustments and will permanently maintain contact to the cable shield
- Designed for high density applications
- Shock and vibration resistant, maintenance free
- Double strain relief: acc. to PROFINET installation guidelines

### Specifications

#### Material

MSKL clamp, SKL clamp	Spring steel, zinc plated
SF/SFZ foot	Spring steel
SK bracket	Steel, galvanically zinc plated

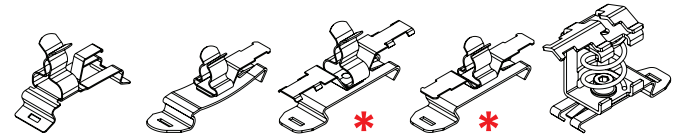

		SFZ-M MSKL	SFZ SKL	SF2Z-M MSKL	SF2Z SKL	SF SKZ
	Clamping range	Order No.	Order No.	Order No.	Order No.	Order No.
MSKL	3 – 12 mm	37620	–	37620.150	–	–
	8 – 18 mm	37622	–	37622.150	–	–
SKL	1.5 – 3 mm	–	36850	–	36850.150	–
	3 – 6 mm	–	36855	–	36855.150	–
	6 – 8 mm	–	36860	–	36860.150	–
	8 – 11 mm	–	36865	–	36865.150	–
	11 – 17 mm	–	36870	–	36870.150	–
	17 – 22 mm	–	36875	–	36875.150	–
	22 – 30 mm	–	36880	–	36880.150	–
SKZ	3 – 8 mm	–	–	–	–	36500
	4 – 13.5 mm	–	–	–	–	36502
	PU	10	10	10	10	10

\* with double strain relief function

# EMC shield clamps for 35 mm top hat DIN rails without strain relief



SF5|SKL

Whenever a cable shielding is required with the possibility of grounding, EMC shield clamps can be used. Shield clamps are easy to use and effective in dissipating conducted disturbances.

### Assembly

The shield clamps can be mounted on 35 mm top hat DIN rails.

### Advantages & benefits

- Large cable shield contact area
- Easy, tool-free assembly
- The spring design requires no adjustments and will permanently maintain contact to the cable shield
- Designed for high density applications
- Shock and vibration resistant, maintenance free

### Specifications

#### Material

MSKL clamp, SKL clamp	Spring steel, zinc plated
SF/SFZ foot	Spring steel
SK bracket	Steel, galvanically zinc plated

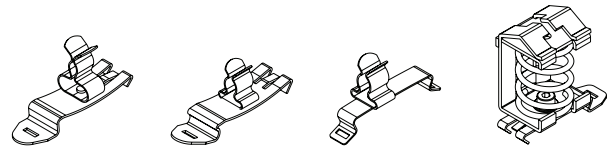

		SF-M MSKL	SF SKL	SFS SKL	SF SK
	Clamping range	Order No.	Order No.	Order No.	Order No.
MSKL	3 – 12 mm	37616	–	–	–
	8 – 18 mm	37618	–	–	–
SKL	1.5 – 3 mm	–	36243	36810	–
	3 – 6 mm	–	36244	36815	–
	6 – 8 mm	–	36245	36820	–
	8 – 11 mm	–	36246	–	–
	11 – 17 mm	–	36247	–	–
	17 – 22 mm	–	36248	–	–
	22 – 30 mm	–	36249	–	–
	30 – 38 mm	–	36250	–	–
	38 – 48 mm	–	36252	–	–
	SK	3 – 8 mm	–	–	–
4 – 13.5 mm		–	–	–	36502.002
10 – 20 mm		–	–	–	36504
15 – 32 mm		–	–	–	36506
PU		10	10	10	10

# EMC shield clamps for 10 × 3 mm bus bars with strain relief function



PFSZ-M|MSKL

Whenever a cable shielding is required with the possibility of grounding, EMC shield clamps can be used. Shield clamps are easy to use and effective in dissipating conducted disturbances.

Optional strain relief function: the cable is fixed via the cable jacket using cable ties.

### Assembly

The shield clamps can be mounted on 10 × 3 mm bus bars.

### Advantages & benefits

- Integrated strain relief function
- Large cable shield contact area
- Easy, tool-free assembly
- The spring design requires no adjustments and will permanently maintain contact to the cable shield
- Designed for high density applications
- Shock and vibration resistant, maintenance free
- Double strain relief: acc. to PROFINET installation guidelines

### Specifications

#### Material

MSKL-clamp,	Spring steel, zinc plated
SKL-clamp	Spring steel
PFS-foot	Spring steel
SK-bracket	Sheet steel, galvanically zinc plated
Bus bar	Cu, tin plated, current load 140 A

### Suitable for

KEL-EMV-PF cable assembly bracket	261
MF Supports for bus bars	347

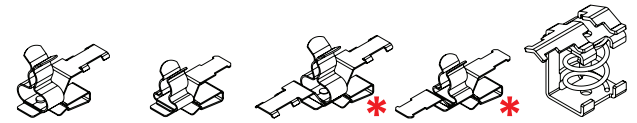

	PFSZ-M MSKL	PFSZ SKL	PFSZ2-M MSKL	PFSZ2Z SKL	SS SKZ
Clamping range	Order No.	Order No.	Order No.	Order No.	Order No.
MSKL	3 – 12 mm	37630	–	37630.150	–
	8 – 18 mm	37632	–	37632.150	–
SKL	1.5 – 3 mm	–	36787.1	–	36787.151
	3 – 6 mm	–	36787.2	–	36787.152
	6 – 8 mm	–	36787.3	–	36787.153
	8 – 11 mm	–	36787.4	–	36787.154
	11 – 17 mm	–	36787.5	–	36787.155
	17 – 22 mm	–	36787.6	–	36787.156
SKZ	3 – 8 mm	–	–	–	36235
	4 – 13.5 mm	–	–	–	36236
PU	10	10	10	10	10

\* with double strain relief function

### Bus bar 10 × 3 mm

Type	Order No.	PU
Bus bar 10 × 3 mm	10 × 3 × 1000 mm*	36100
		1

\* Other lengths available on request

# EMC shield clamps for 10 × 3 mm bus bars without strain relief function



PFS|SKL

Whenever a cable shielding is required with the possibility of grounding, EMC shield clamps can be used. Shield clamps are easy to use and effective in dissipating conducted disturbances.

### Assembly

The shield clamps can be mounted on 10 × 3 mm bus bars.

### Advantages & benefits

- Large cable shield contact area
- Easy, tool-free assembly
- The spring design requires no adjustments and will permanently maintain contact to the cable shield
- Designed for high density applications
- Shock and vibration resistant, maintenance free

### Specifications

#### Material

MSKL-clamp,	Spring steel, zinc plated
SKL-clamp	Spring steel
PFS-foot	Spring steel
SK-bracket	Sheet steel, galvanically zinc plated
Bus bar	Cu, tin plated, current load 140 A

#### Suitable for

KEL-EMV-PF cable assembly bracket	261
MF Supports for bus bars	347

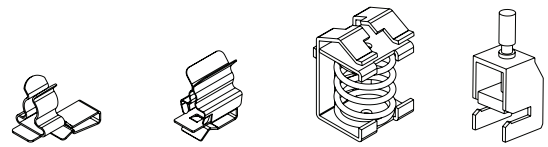

	PFS SKL	PFS SCL	SS SK	SKS
Clamping range	Order No.	Order No.	Order No.	Order No.
SKL	1.5 – 3 mm	36786.1	36611	–
	3 – 6 mm	36786.2	36612	–
	6 – 8 mm	36786.3	–	–
	8 – 11 mm	36786.4	–	–
	11 – 17 mm	36786.5	–	–
	17 – 22 mm	36786.6	–	–
SK	3 – 8 mm	–	36235.002	–
	4 – 13.5 mm	–	36236.002	–
	10 – 20 mm	–	36237	–
	15 – 32 mm	–	36238	–
SKS	2 – 5 mm	–	–	36282
	3 – 8 mm	–	–	36283
	3 – 14 mm	–	–	36284
	3 – 20 mm	–	–	36285
	5 – 28 mm	–	–	36286
	20 – 35 mm	–	–	36287
PU	10	10	10	10

# EMC double shield clamps for 10 × 3 mm bus bars with strain relief function

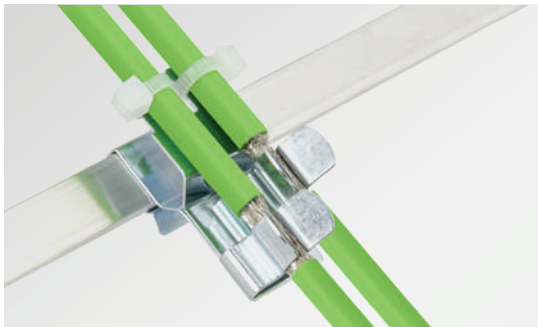

PFSZ2|SKL

Whenever a cable shielding is required with the possibility of grounding, EMC shield clamps can be used. Shield clamps are easy to use and effective in dissipating conducted disturbances.

Optional strain relief function: the cable is fixed via the cable jacket using cable ties.

### Assembly

The shield clamps can be mounted on 10 × 3 mm bus bars.

### Advantages & benefits

- Integrated strain relief function
- Large cable shield contact area
- Easy, tool-free assembly
- The spring design requires no adjustments and will permanently maintain contact to the cable shield
- Designed for high density applications
- Shock and vibration resistant, maintenance free

### Specifications

#### Material

MSKL-clamp,	Spring steel, zinc plated
SKL-clamp	Spring steel
PFS-foot	Spring steel
Bus bar	Cu, tin plated, current load 140 A

#### Accessories

Bus bar	235
MF Supports for bus bars	347

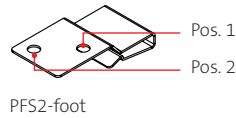

PFS2-foot

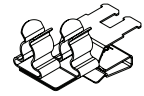

PFSZ2|SKL

	Clamping range Pos. 1	Clamping range Pos. 2	Order No.
SKL	blank	1.5 – 3 mm	36789.01
	blank	3 – 6 mm	36789.02
	blank	6 – 8 mm	36789.03
	blank	8 – 11 mm	36789.04
	1.5 – 3 mm	blank	36789.10
	1.5 – 3 mm	1.5 – 3 mm	36789.11
	1.5 – 3 mm	3 – 6 mm	36789.12
	1.5 – 3 mm	6 – 8 mm	36789.13
	1.5 – 3 mm	8 – 11 mm	36789.14
	3 – 6 mm	blank	36789.20
	3 – 6 mm	1.5 – 3 mm	36789.21
	3 – 6 mm	3 – 6 mm	36789.22
	3 – 6 mm	6 – 8 mm	36789.23
	3 – 6 mm	8 – 11 mm	36789.24
	6 – 8 mm	blank	36789.30
	6 – 8 mm	1.5 – 3 mm	36789.31
	6 – 8 mm	3 – 6 mm	36789.32
	6 – 8 mm	6 – 8 mm	36789.33
	6 – 8 mm	8 – 11 mm	36789.34
	8 – 11 mm	blank	36789.40
	8 – 11 mm	1.5 – 3 mm	36789.41
	8 – 11 mm	3 – 6 mm	36789.42
	8 – 11 mm	6 – 8 mm	36789.43
	PU		



# EMC double shield clamps for 10 × 3 mm bus bars without strain relief function



PFS2|SKL

Whenever a cable shielding is required with the possibility of grounding, EMC shield clamps can be used. Shield clamps are easy to use and effective in dissipating conducted disturbances.

### Assembly

The shield clamps can be mounted on 10 × 3 mm bus bars.

### Advantages & benefits

- Large cable shield contact area
- Easy, tool-free assembly
- The spring design requires no adjustments and will permanently maintain contact to the cable shield
- Designed for high density applications
- Shock and vibration resistant, maintenance free

### Specifications

#### Material

MSKL-clamp,	Spring steel, zinc plated
SKL-clamp	Spring steel
PFS-foot	Spring steel
Bus bar	Cu, tin plated, current load 140 A

### Accessories

Bus bar	235
MF Supports for bus bars	347

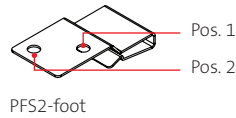

PFS2-foot

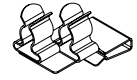

PFS2 SKL		
Clamping range Pos. 1	Clamping range Pos. 2	Order No.
blank	1.5 – 3 mm	36788.01
blank	3 – 6 mm	36788.02
blank	6 – 8 mm	36788.03
blank	8 – 11 mm	36788.04
1.5 – 3 mm	blank	36788.10
1.5 – 3 mm	1.5 – 3 mm	36788.11
1.5 – 3 mm	3 – 6 mm	36788.12
1.5 – 3 mm	6 – 8 mm	36788.13
1.5 – 3 mm	8 – 11 mm	36788.14
3 – 6 mm	blank	36788.20
3 – 6 mm	1.5 – 3 mm	36788.21
3 – 6 mm	3 – 6 mm	36788.22
3 – 6 mm	6 – 8 mm	36788.23
3 – 6 mm	8 – 11 mm	36788.24
6 – 8 mm	blank	36788.30
6 – 8 mm	1.5 – 3 mm	36788.31
6 – 8 mm	3 – 6 mm	36788.32
6 – 8 mm	6 – 8 mm	36788.33
6 – 8 mm	8 – 11 mm	36788.34
8 – 11 mm	blank	36788.40
8 – 11 mm	1.5 – 3 mm	36788.41
8 – 11 mm	3 – 6 mm	36788.42
8 – 11 mm	6 – 8 mm	36788.43
PU		10

4  
4.1  
4.2  
4.3  
4.4

# EMC shield clamps for 30 mm C-rails with strain relief function

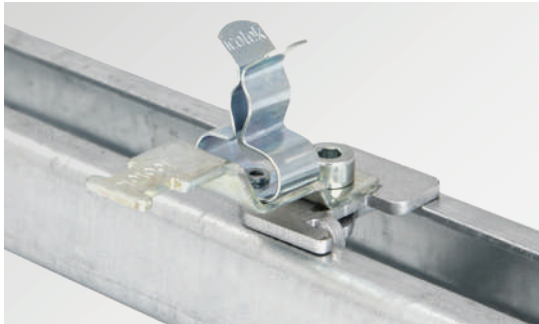

SC|LFZ-M|MSKL

Whenever a cable shielding is required with the possibility of grounding, EMC shield clamps can be used. Shield clamps are easy to use and effective in dissipating conducted disturbances.

Optional strain relief function: the cable is fixed via the cable jacket using cable ties.

### Assembly

The shield clamps can be mounted on 30 mm C-rails using the SC mounting foot (included in the shipment).

### Advantages & benefits

- Integrated strain relief function
- Large cable shield contact area
- Easy, tool-free assembly
- The spring design requires no adjustments and will permanently maintain contact to the cable shield
- Designed for high density applications
- Shock and vibration resistant, maintenance free
- Double strain relief: acc. to PROFINET installation guidelines
- For mounting on all common C-rails with an opening dimension of 16–17 mm

### Specifications

#### Material

MSKL-clamp	Sheet steel, galvanically zinc plated
SKL-clamp	Fixing hole M4
LFZ foot	Sheet steel, galvanically zinc plated
SC foot	Sheet steel, galvanically zinc plated
SK-bracket	Sheet steel, galvanically zinc plated

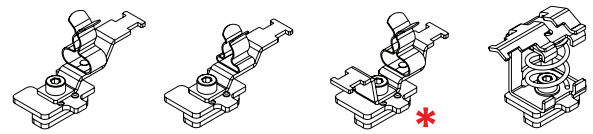

	SC LFZ-M MSKL Fixing hole M4	SC LFZ SKL Fixing hole M4	SC LFZ2-M MSKL Fixing hole M4	SC SKZ
Clamping range	Order No.	Order No.	Order No.	Order No.
MSKL	3 – 12 mm	37612.100	–	37612.150
	8 – 18 mm	37614.100	–	37614.150
SKL	1.5 – 3 mm	–	36910.100	–
	3 – 6 mm	–	36915.100	–
	6 – 8 mm	–	36920.100	–
	8 – 11 mm	–	36925.100	–
	11 – 17 mm	–	36930.100	–
	17 – 22 mm	–	36935.100	37594.150
	22 – 30 mm	–	36940.100	37595.150
SKZ	3 – 8 mm	–	–	36696
	4 – 13.5 mm	–	–	36700
PU	10	10	10	10

\* with double strain relief function



SC foot single for C-rail  
PU: 10, Order No. 36220



Screw-foot loose, for 30 mm DIN-rail shape C (width of mouth: 16 – 17 mm) with twist protection notch  
PU: 10, Order No. 36231

SC-foot: space-saving design enables high cable density. Mounting foot adjusts itself when tightening the screw.

# EMC shield clamps for 30 mm C-rails without strain relief function



SC|LF|SKL

Whenever a cable shielding is required with the possibility of grounding, EMC shield clamps can be used. Shield clamps are easy to use and effective in dissipating conducted disturbances.

### Assembly

The shield clamps can be mounted on 30 mm C-rails using the SC mounting foot (included in the shipment).

### Advantages & benefits

- Large cable shield contact area
- Easy, tool-free assembly
- The spring design requires no adjustments and will permanently maintain contact to the cable shield
- Designed for high density applications
- Shock and vibration resistant, maintenance free

### Specifications

#### Material

MSKL-clamp,	Spring steel, zinc plated
SKL-clamp	Sheet steel, galvanically zinc plated
LF foot	Fixing hole M4
SC foot	Sheet steel, galvanically zinc plated
SK-bracket	Sheet steel, galvanically zinc plated

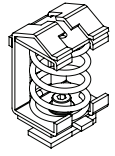
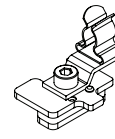
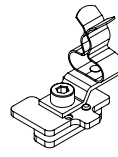

		SC LF MSKL Fixing hole M4	SC LF SKL Fixing hole M4	SC SK
Clamping range		Order No.	Order No.	Order No.
MSKL	3 – 12 mm	37608.100	–	–
	8 – 18 mm	37610.100	–	–
SKL	1.5 – 3 mm	–	36251.100	–
	3 – 6 mm	–	36253.100	–
	6 – 8 mm	–	36255.100	–
	8 – 11 mm	–	36256.100	–
	11 – 17 mm	–	36257.100	–
	17 – 22 mm	–	36258.100	–
SK	22 – 30 mm	–	36259.100	–
	3 – 8 mm	–	–	36696.002
	4 – 13.5 mm	–	–	36700.002
	10 – 20 mm	–	–	36704
	15 – 32 mm	–	–	36708
PU		10	10	10

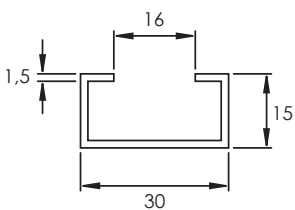

C-rail dimensions (mm)

4  
4.1  
4.2  
4.3  
4.4

# EMC shield clamps for cable clamps for 30 mm C-rails



LFC|MSKL

The LFC shield clamp offers a space-saving solution for mounting on the C-rail.

The shield clamp LFC contacts the cable shield directly on the C-rail while the use of the existing cable clamp provides the strain relief.

Whenever a cable shielding is required with the possibility of grounding, EMC shield clamps can be used. Shield clamps are easy to use and effective in dissipating conducted disturbances.

### Advantages & benefits

- Suitable for clamps that are mounted on C-rails
- Easy, tool-free assembly
- Space-saving assembly
- Large clamping range 3 – 30 mm
- Large cable shield contact area
- Shield contacting and strain relief are separated from each other
- For mounting on all common C-rails with an opening dimension of 16–17 mm

### Specifications

Material                      Spring steel galvanised

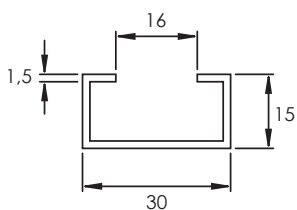

C-rail dimensions (mm)

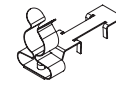

		LFC MSKL	LFC SKL
Clamping range		Order No.	Order No.
MSKL	3 – 12 mm	37670.100	–
	8 – 18 mm	37671.100	–
SKL	17 – 22 mm	–	37672.100
	22 – 30 mm	–	37673.100
PU		10	10



# Product set of EMC shield clamps and cable clamps for 30 mm C-rails

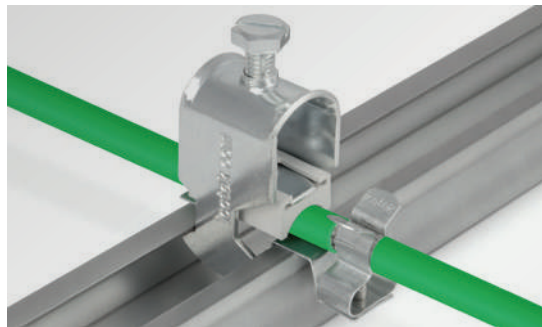

CC-LFC|MSKL

Convenient product set consisting of the LFC EMC shield clamp for contacting the cable shield and discharging interference currents in combination with the matching CCL cable clamp for strain relief on the cable jacket.

The combination of two products helps to save space and material in the enclosure. The EMC connection of the cables no longer has to be made via an additional top hat DIN rail or bus bar.

### Advantages & benefits

- Space-saving due to the combination of the LFC shield clamp with the CCL cable clamp
- Quick and easy assembly
- Large variety of clamping areas
- Large cable shield contact area
- Shield contacting and strain relief are separated from each other
- For mounting on all common C-rails with an opening dimension of 16–17 mm

### Specifications

#### Material

LFC: Spring steel galvanised  
 Cable clamp: Steel galvanised

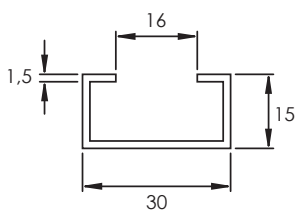

C-rail dimensions (mm)

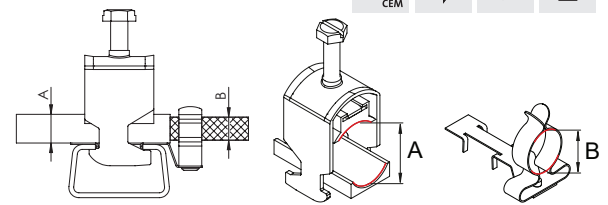

Clamping ranges

Type	Clamping range A Cable clamp (∅ on the cable sheath)	Clamping range B Shield clamp (∅ on the cable shield)	Order No.	PU
CC-LFC 6-13   MSKL 3-12	6 – 13 mm	3 – 12 mm	37680	10
CC-LFC 12-19   MSKL 8-18	12 – 19 mm	8 – 18 mm	37681	10
CC-LFC 18-23   SKL 17-22	18 – 23 mm	17 – 22 mm	37682	10
CC-LFC 23-32   SKL 22-30	23 – 32 mm	22 – 30 mm	37683	10
CC-LFC 32-38   SKL 30-38	32 – 38 mm	30 – 38 mm	37688	10
CC-LFC 38-42   SKL 30-38	38 – 42 mm	30 – 38 mm	37684	10
CC-LFC 42-50   SKL 38-48	42 – 50 mm	38 – 48 mm	37685	10
CC-LFC 50-64   SKL 44-56	50 – 64 mm	44 – 56 mm	37686	10
CC-LFC 50-64   SKL 56-68	50 – 64 mm	56 – 68 mm	37687	10

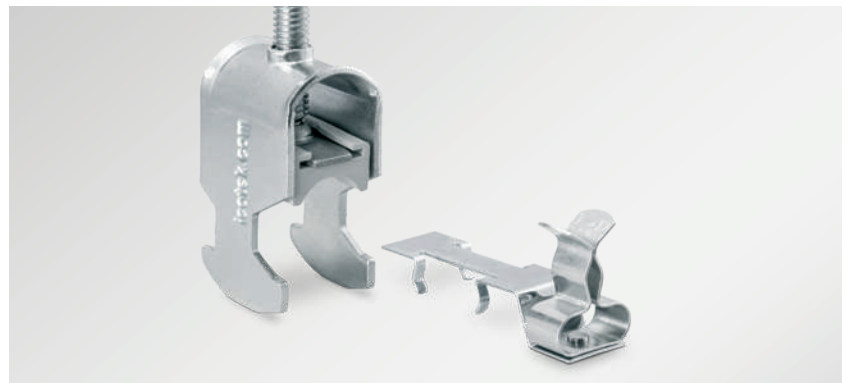

4  
 4.1  
 4.2  
 4.3  
 4.4

# EMC shield clamps for assembly on sheet edges with strain relief function

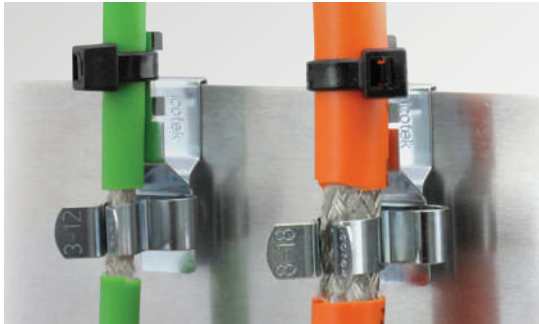

Whenever a cable shielding is required with the possibility of grounding, EMC shield clamps can be used. Shield clamps are easy to use and effective in dissipating conducted disturbances.

Optional strain relief function: the cable is fixed via the cable jacket using cable ties.

### Assembly

The shield clamps are used where a screw connection is either not possible or wanted. It is simply clamped onto the sheet edge. The claws provide a secure grip, even in case of vibrations.

### Advantages & benefits

- Integrated strain relief function
- Large cable shield contact area
- Easy, tool-free assembly
- The spring design requires no adjustments and will permanently maintain contact to the cable shield
- Designed for high density applications
- Maintenance free

### Specifications

#### Material

SKL-clamp      Spring steel, zinc plated  
PFKZ foot      Spring steel

Type A:          For wall/sheet thickness 1.5 – 2 mm

Type B:          For wall/sheet thickness 2 – 3 mm

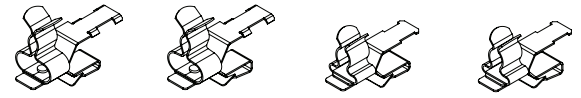

		PFKZ-A-M MSKL for sheet thickness 1.5 – 2 mm	PFKZ-B-M MSKL for sheet thickness 2 – 3 mm	PFKZ-A SKL for sheet thickness 1.5 – 2 mm	PFKZ-B SKL for sheet thickness 2 – 3 mm
	Clamping range	Order No.	Order No.	Order No.	Order No.
MSKL	3 – 12 mm	37640	37650	–	–
	8 – 18 mm	37642	37652	–	–
SKL	1.5 – 3 mm	–	–	36779.1	36783.1
	3 – 6 mm	–	–	36779.2	36783.2
	6 – 8 mm	–	–	36779.3	36783.3
	8 – 11 mm	–	–	36779.4	36783.4
	11 – 17 mm	–	–	36779.5	36783.5
	17 – 22 mm	–	–	36779.6	36783.6
	22 – 30 mm	–	–	36779.7	36783.7
	PU	10	10	10	10

# EMC shield clamps for assembly on sheet edges without strain relief function



Whenever a cable shielding is required with the possibility of grounding, EMC shield clamps can be used. Shield clamps are easy to use and effective in dissipating conducted disturbances.

### Assembly

The shield clamps are used where a screw connection is either not possible or wanted. It is simply clamped onto the sheet edge. The claws provide a secure grip, even in case of vibrations.

### Advantages & benefits

- Large cable shield contact area
- Easy, tool-free assembly
- The spring design requires no adjustments and will permanently maintain contact to the cable shield
- Designed for high density applications
- Maintenance free

### Specifications

#### Material

SKL-clamp      Spring steel, zinc plated  
PFK foot        Spring steel

Type A:        For wall/sheet thickness 1.5 – 2 mm  
Type B:        For wall/sheet thickness 2 – 3 mm



PFK-A|SKL  
for sheet thickness  
1.5 – 2 mm



PFK-B|SKL  
for sheet thickness  
2 – 3 mm

Clamping range	Order No.	Order No.	
SKL	1.5 – 3 mm	36778.1	36782.1
	3 – 6 mm	36778.2	36782.2
	6 – 8 mm	36778.3	36782.3
	8 – 11 mm	36778.4	36782.4
	11 – 17 mm	36778.5	36782.5
	17 – 22 mm	36778.6	36782.6
	22 – 30 mm	36778.7	36782.7
PU	10	10	

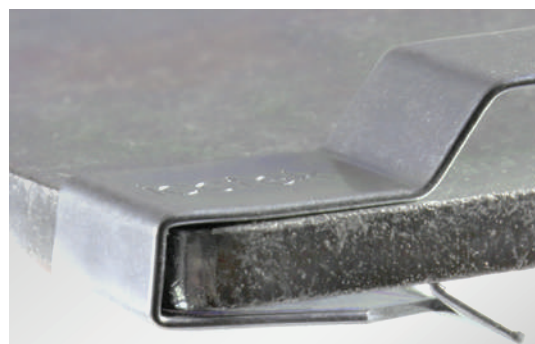

Secure grip on metal sheets due to mounting claws

4  
4.1  
4.2  
4.3  
4.4

# EMC double shield clamps for assembly on sheet edges with strain relief function

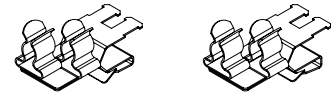
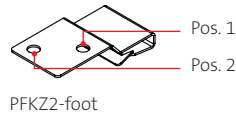

Whenever a cable shielding is required with the possibility of grounding, EMC shield clamps can be used. Shield clamps are easy to use and effective in dissipating conducted disturbances.

Optional strain relief function: the cable is fixed via the cable jacket using cable ties.

## Assembly

The shield clamps are used where a screw connection is either not possible or wanted. It is simply clamped onto the sheet edge. The claws provide a secure grip, even in case of vibrations.

## Advantages & benefits

- Integrated strain relief function
- Large cable shield contact area
- Easy, tool-free assembly
- The spring design requires no adjustments and will permanently maintain contact to the cable shield
- Designed for high density applications
- Maintenance free

## Specifications

### Material

SKL-clamp      Spring steel, zinc plated  
PFKZ2 foot     Spring steel

Type A:        For wall/sheet thickness 1.5 – 2 mm

Type B:        For wall/sheet thickness 2 – 3 mm

	PFKZ2-A SKL for sheet thickness 1.5 – 2 mm		PFKZ2-B SKL for sheet thickness 2 – 3 mm	
	Clamping range Pos. 1	Clamping range Pos. 2	Order No.	Order No.
SKL	blank	1.5 – 3 mm	36781.01	36785.01
	blank	3 – 6 mm	36781.02	36785.02
	blank	6 – 8 mm	36781.03	36785.03
	blank	8 – 11 mm	36781.04	36785.04
	1.5 – 3 mm	blank	36781.10	36785.10
	1.5 – 3 mm	1.5 – 3 mm	36781.11	36785.11
	1.5 – 3 mm	3 – 6 mm	36781.12	36785.12
	1.5 – 3 mm	6 – 8 mm	36781.13	36785.13
	1.5 – 3 mm	8 – 11 mm	36781.14	36785.14
	3 – 6 mm	blank	36781.20	36785.20
	3 – 6 mm	1.5 – 3 mm	36781.21	36785.21
	3 – 6 mm	3 – 6 mm	36781.22	36785.22
	3 – 6 mm	6 – 8 mm	36781.23	36785.23
	3 – 6 mm	8 – 11 mm	36781.24	36785.24
PU	6 – 8 mm	blank	36781.30	36785.30
	6 – 8 mm	1.5 – 3 mm	36781.31	36785.31
	6 – 8 mm	3 – 6 mm	36781.32	36785.32
	6 – 8 mm	6 – 8 mm	36781.33	36785.33
	6 – 8 mm	8 – 11 mm	36781.34	36785.34
	8 – 11 mm	blank	36781.40	36785.40
	8 – 11 mm	1.5 – 3 mm	36781.41	36785.41
	8 – 11 mm	3 – 6 mm	36781.42	36785.42
	8 – 11 mm	6 – 8 mm	36781.43	36785.43
		10		10



# EMC double shield clamps for assembly on sheet edges without strain relief function

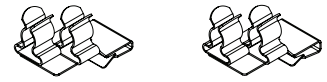
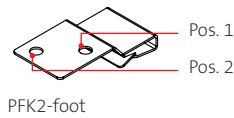

Whenever a cable shielding is required with the possibility of grounding, EMC shield clamps can be used. Shield clamps are easy to use and effective in dissipating conducted disturbances.

### Assembly

The shield clamps are used where a screw connection is either not possible or wanted. It is simply clamped onto the sheet edge. The claws provide a secure grip, even in case of vibrations.

### Advantages & benefits

- Large cable shield contact area
- Easy, tool-free assembly
- The spring design requires no adjustments and will permanently maintain contact to the cable shield
- Designed for high density applications
- Maintenance free

### Specifications

#### Material

SKL-clamp Spring steel, zinc plated  
PFK2 foot Spring steel

Type A: For wall/sheet thickness 1.5 – 2 mm  
Type B: For wall/sheet thickness 2 – 3 mm



Secure grip on metal sheets due to mounting claws

	PFK2-A SKL for sheet thickness 1.5 – 2 mm		PFK2-B SKL for sheet thickness 2 – 3 mm	
	Clamping range Pos. 1	Clamping range Pos. 2	Order No.	Order No.
SKL	blank	1.5 – 3 mm	36780.01	36784.01
	blank	3 – 6 mm	36780.02	36784.02
	blank	6 – 8 mm	36780.03	36784.03
	blank	8 – 11 mm	36780.04	36784.04
	1.5 – 3 mm	blank	36780.10	36784.10
	1.5 – 3 mm	1.5 – 3 mm	36780.11	36784.11
	1.5 – 3 mm	3 – 6 mm	36780.12	36784.12
	1.5 – 3 mm	6 – 8 mm	36780.13	36784.13
	1.5 – 3 mm	8 – 11 mm	36780.14	36784.14
	3 – 6 mm	blank	36780.20	36784.20
	3 – 6 mm	1.5 – 3 mm	36780.21	36784.21
	3 – 6 mm	3 – 6 mm	36780.22	36784.22
	3 – 6 mm	6 – 8 mm	36780.23	36784.23
	3 – 6 mm	8 – 11 mm	36780.24	36784.24
	6 – 8 mm	blank	36780.30	36784.30
	6 – 8 mm	1.5 – 3 mm	36780.31	36784.31
	6 – 8 mm	3 – 6 mm	36780.32	36784.32
	6 – 8 mm	6 – 8 mm	36780.33	36784.33
	6 – 8 mm	8 – 11 mm	36780.34	36784.34
	8 – 11 mm	blank	36780.40	36784.40
	8 – 11 mm	1.5 – 3 mm	36780.41	36784.41
	8 – 11 mm	3 – 6 mm	36780.42	36784.42
	8 – 11 mm	6 – 8 mm	36780.43	36784.43
	PU		10	10

4  
4.1  
4.2  
4.3  
4.4



PCB|SKL shield clamps are easy to use and effective in earthing single cable shields.

PCB|SKL consist of SKL clamps, fixed on a soldering foot that enables assembly on printed circuit boards. There are various designs to choose from.

**Advantages & benefits**

- The spring design requires no adjustments and will permanently maintain contact to the cable shield
- Large contact area

**Specifications**

**Material**

SKL-clamp                      Spring steel, zinc plated  
PCB-foot                        Brass, tin plated

SKL-clamp  
PCB-ET-4-V-4,1|SKL 3-6      Spring steel, tin plated

Type	Order No.	Height H [mm]	Height h1 [mm]	Width s [mm]	Pin h [mm]	Pin S [mm]	Grid a x b [mm]	Drill-hole d [mm]	PU
PCB-4-V-6,8 MSKL 3-12 Clamping range 3–12 mm	37306	27	6.8	0.8	2.6	1.6	5 x 7.2	Ø 1.8	10
PCB-4-V-6,8 SKL 1.5-3 Clamping range 1.5 - 3 mm	36650.1	20	6.8	0.8	2.6	1.6	5 x 7.2	Ø 1.8	10
PCB-4-V-6,8 SKL 3-6 Clamping range 3 - 6 mm	36650.2	20	6.8	0.8	2.6	1.6	5 x 7.2	Ø 1.8	10
PCB-4-V-6,8 SKL 6-8 Clamping range 6 - 8 mm	36650.3	22	6.8	0.8	2.6	1.6	5 x 7.2	Ø 1.8	10
PCB-4-V-6,8 SKL 8-11 Clamping range 8–11 mm	36650.4	27	6.8	0.8	2.6	1.6	5 x 7.2	Ø 1.8	10
PCB-4-V-12,5 SKL 1.5-3 Clamping range 1.5 - 3 mm	36656.1	25	12.5	1	4	1.6	5 x 10.1	Ø 1.8	10
PCB-4-V-12,5 SKL 3-6 Clamping range 3 - 6 mm	36656.2	26	12.5	1	4	1.6	5 x 10.1	Ø 1.8	10
PCB-4-V-12,5 SKL 6-8 Clamping range 6 - 8 mm	36656.3	27	12.5	1	4	1.6	5 x 10.1	Ø 1.8	10
PCB-ET-4-V-4,1 SKL 3-6 Clamping range 3 - 6 mm (one-piece)	36653.1	17.5	4.4	0.3	2.6	1.6	5 x 7.2	Ø 1.8	25

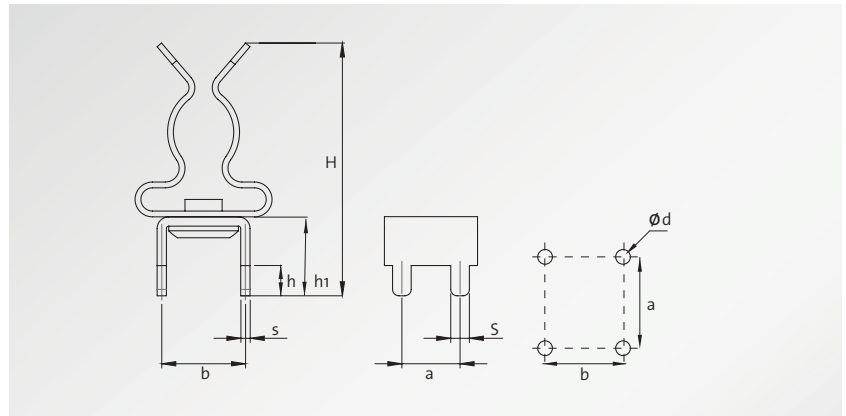

# STFZ|SKL

## EMC Terminal clamp for peripheral modules



STFZ-U|SKL

The EMC terminal clamps STFZ|SKL combine the functions strain relief, cable guidance and earthing of signal cables. Available in two versions for 1 or 2 lines.

The STFZ2|SKL is used for analogue I/O modules using two actuators/sensors.

The STFZ EMC terminal clamp is compatible to bus modules listed on the left side.

For the SIMATIC ET 200SP module by Siemens icotek has developed a special terminal clamp STFZ-SP for 1 or 2 lines.

## Application terminal clamp

### STFZ|SKL

- Bosch Rexroth  
IP20 Inline Module
- PHOENIX CONTACT  
All terminals of the INLINE range.  
The terminals 1.4 and 2.4 must not be used for signal I/O.
- Pilz  
All PSSu-Modules with shield terminals 13 and 23
- Siemens  
All terminals of the ET200s range.  
Terminals 4 and 8 must not be used for signal I/O.
- TURCK  
For terminals of the BL20 I/O system.
- VIPA SLIO  
All terminals of the SLIO range. Terminals 4+8 must not be used for signal I/O.
- WAGO  
All terminals of the WAGO I/O Systems 750.  
Terminals 4 and 8 must not be used for signal I/O.
- Rockwell Automation / Allen-Bradley  
Series 1734

Further manufacturers upon request.



### STFZ I/O Insert Tool

STFZ I/O Insert Tool for quick and easy mounting of STFZ terminal clamps.

**Order No. 61430**

### STFZ-U|SKL

- BECKHOFF  
EL 3122, ES 3122, ES 9100, ES 9410, KL 1114, KS 2134
- OMRON  
Series NX

### STFZ-SP|SKL

- Siemens  
SIMATIC ET 200SP



STFZ-SP|SKL

STFZ-U|SKL

STFZ|SKL

4  
4.1  
4.2  
4.3  
4.4

# STFZ | STFZ2

EMC Terminal clamp, single and double for various brands

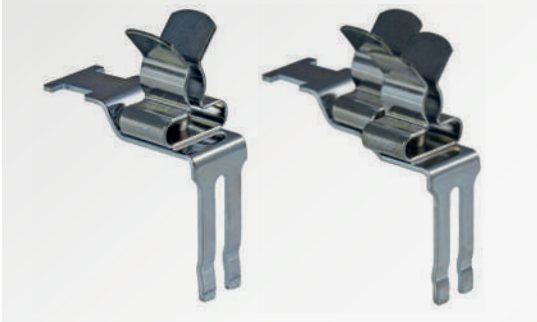

The STFZ|SKL EMC terminal clamp provides strain relief, cable guidance and earthing for decentralised bus modules (see compatibility table page 212).

The STFZ2|SKL is used for analogue I/O modules using two actuators / sensors.

The EMC shield clamps as listed below are available to mount:

SKL 1.5-3 | SKL 3-6 | SKL 6-8

### Advantages & benefits

- Earthing of signal cables close to the terminal
- Strain relief and cable management directly on the bus module

### Specifications

#### Material

SKL-clamp Spring steel, zinc plated  
STFZ-foot Spring steel

### Accessories

STFZ I/O Insert Tool 251

Type	Shield diameter Pos. 1	Shield diameter Pos. 2	Order No.	PU
<b>STFZ SKL with one shield clamp:</b>				
STFZ SKL 1.5-3	1.5 - 3 mm	-	37510.1	10
STFZ SKL 3-6	3 - 6 mm	-	37510.2	10
STFZ SKL 6-8	6 - 8 mm	-	37510.3	10
<b>STFZ2 SKL with two shield clamps:</b>				
STFZ2 01	blank	1.5 - 3 mm	37505.01	10
STFZ2 02	blank	3 - 6 mm	37505.02	10
STFZ2 03	blank	6 - 8 mm	37505.03	10
STFZ2 10	1.5 - 3 mm	blank	37505.10	10
STFZ2 11	1.5 - 3 mm	1.5 - 3 mm	37505.11	10
STFZ2 12	1.5 - 3 mm	3 - 6 mm	37505.12	10
STFZ2 13	1.5 - 3 mm	6 - 8 mm	37505.13	10
STFZ2 20	3 - 6 mm	blank	37505.20	10
STFZ2 21	3 - 6 mm	1.5 - 3 mm	37505.21	10
STFZ2 22	3 - 6 mm	3 - 6 mm	37505.22	10
STFZ2 23	3 - 6 mm	6 - 8 mm	37505.23	10
STFZ2 30	6 - 8 mm	blank	37505.30	10
STFZ2 31	6 - 8 mm	1.5 - 3 mm	37505.31	10
STFZ2 32	6 - 8 mm	3 - 6 mm	37505.32	10
STFZ2 33	6 - 8 mm	6 - 8 mm	37505.33	10

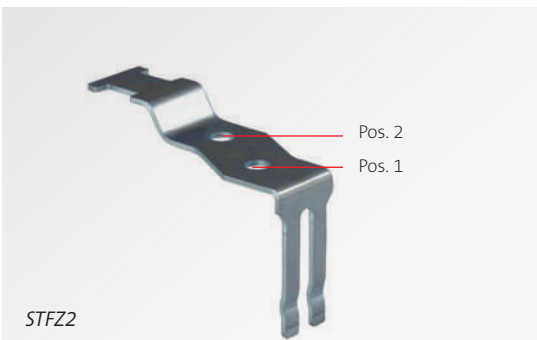

# STFZ-U | STFZ-SP | STFZ2-SP

EMC Terminal clamp, single and double for Siemens & Beckhoff modules



STFZ-SP|SKL

STFZ2-SP|SKL

The STFZ-SP|SKL EMC terminal clamp provides strain relief, cable guidance and earthing for decentralised bus modules SIMATIC ET 200SP by Siemens. STFZ2-SP|SKL is a version for analogue I/O modules using two actuators/sensors. STFZ-U terminal clamps for various Beckhoff modules.

The EMC shield clamps as listed below are available to mount:

SKL 1.5-3 | SKL 3-6 | SKL 6-8

### Advantages & benefits

- Earthing of signal cables close to the terminal
- Strain relief and cable management directly on the bus module

### Specifications

#### Material

SKL-clamp            Spring steel, zinc plated  
STFZ-SP-foot        Spring steel

#### Accessories

STFZ I/O Insert Tool    251

Type	Shield diameter Pos. 1	Shield diameter Pos. 2	Order No.	PU
<b>STFZ-SP SKL / STFZ-U SKL with one shield clamp:</b>				
STFZ-SP SKL 1.5-3	1.5 - 3 mm	-	37512.1	10
STFZ-U SKL 1.5-3	1.5 - 3 mm	-	37514.1	10
STFZ-SP SKL 3-6	3 - 6 mm	-	37512.2	10
STFZ-U SKL 3-6	3 - 6 mm	-	37514.2	10
STFZ-SP SKL 6-8	6 - 8 mm	-	37512.3	10
STFZ-U SKL 6-8	6 - 8 mm	-	37514.3	10
<b>STFZ2-SP with two shield clamps:</b>				
STFZ2-SP 01	blank	1.5 - 3 mm	37507.01	10
STFZ2-SP 02	blank	3 - 6 mm	37507.02	10
STFZ2-SP 03	blank	6 - 8 mm	37507.03	10
STFZ2-SP 10	1.5 - 3 mm	blank	37507.10	10
STFZ2-SP 11	1.5 - 3 mm	1.5 - 3 mm	37507.11	10
STFZ2-SP 12	1.5 - 3 mm	3 - 6 mm	37507.12	10
STFZ2-SP 13	1.5 - 3 mm	6 - 8 mm	37507.13	10
STFZ2-SP 20	3 - 6 mm	blank	37507.20	10
STFZ2-SP 21	3 - 6 mm	1.5 - 3 mm	37507.21	10
STFZ2-SP 22	3 - 6 mm	3 - 6 mm	37507.22	10
STFZ2-SP 23	3 - 6 mm	6 - 8 mm	37507.23	10
STFZ2-SP 30	6 - 8 mm	blank	37507.30	10
STFZ2-SP 31	6 - 8 mm	1.5 - 3 mm	37507.31	10
STFZ2-SP 32	6 - 8 mm	3 - 6 mm	37507.32	10
STFZ2-SP 33	6 - 8 mm	6 - 8 mm	37507.33	10

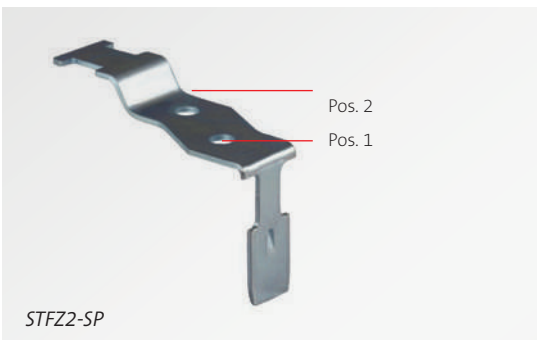

STFZ2-SP

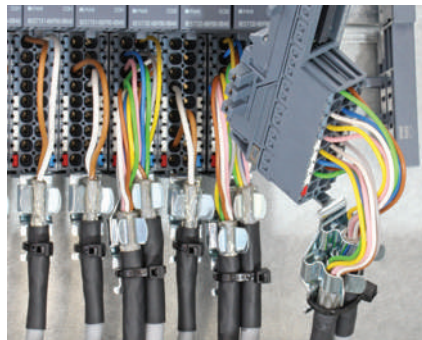

STFZ-U|SKL

4  
4.1  
4.2  
4.3  
4.4

# EMC ServiceBox *multi*

Service box with assorted MSKL shield clamp



The suitable EMC clamp is always readily available!  
The EMC ServiceBox multi is very universal, especially when the cable diameter is unknown in advance. With the new ServiceBox multi you always have the right size on hand.

The EMC ServiceBox multi is perfect for installations and service calls. Retrofitting and maintenance can be carried out easily and quickly.

### Content\*

#### MSKL / SKL for top hat DIN rails:

Type SFZ-M|MSKL - sizes: 8 - 18 mm      10 × MSKL  
Type SFZ-M|MSKL - sizes: 3 - 12 mm      20 × MSKL  
Type SFZ|SKL - sizes: 1.5 - 3 mm          10 × SKL

#### MSKL / SKL for assembly via screws:

Type LFZ-M|MSKL - sizes: 8 - 18 mm      10 × MSKL  
Type LFZ-M|MSKL - sizes: 3 - 12 mm      20 × MSKL  
Type LFZ|SKL - sizes: 1.5 - 3 mm          10 × SKL

#### MSKL for 10 × 3 mm bus bar:

Type PFSZ-M|MSKL - sizes: 3 - 12 mm      10 × MSKL

#### MSKL / SKL for clipping on metal sheets:

Type PFKZ-B-M|MSKL - sizes: 1.5 - 8 mm    10 × MSKL  
Type PFKZ-B|SKL 22                              2 × SKL

#### SKL for decentralised bus modules:

Type STFZ|SKL - sizes: 3 - 6 mm              6 × SKL

#### SKL for clipping on metal sheets

Typ PFKZ-B|SKL 1,5-3 mm                      3 × SKL  
Typ PFKZ-B|SKL 3-6 mm                        3 × SKL  
Typ PFKZ-B|SKL 6-8 mm                        3 × SKL

#### EMC - Accessories:

RLFZ - Clamp assembly 5 × SKL              1 piece

\* Subject to alterations

Description	Order No.	PU
EMC ServiceBox <i>multi</i>	88006	1

# EMC ServiceBox

Service box with assorted SKL shield clamps



The suitable EMC clamp is always readily available!  
The EMC ServiceBox is perfect for installations and service calls. Retrofitting and maintenance can be carried out easily and quickly.

### Content\*

#### SKL for top hat DIN rails:

- Type SFZ|SKL - sizes: 1.5 - 17 mm 15 × SKL
- Type SFS|SKL - sizes: 1.5 - 8 mm 6 × SKL
- SFZ-M|MSKL - sizes: 3-18 mm 4 × SKL

#### SKL for assembly via screws:

- Type LFZ|SKL - sizes: 1.5 - 17 mm 21 × SKL
- Type LFZ-U4|SKL - sizes: 1.5-11 mm 8 × SKL
- Type LFZ-M|MSKL - sizes: 3-18 mm 4 × SKL

#### SKL for 10 × 3 bus bar:

- Type PFSZ2|SKL 11 1 × SKL
- Type PFSZ2|SKL 22 1 × SKL
- Type PFSZ2|SKL 33 1 × SKL

#### SKL for clipping on metal sheets:

- Type PFSZ|SKL - sizes: 1.5 - 11 mm 15 × SKL
- Type PFSZ-M|MSKL - sizes: 3-18 mm 4 × SKL

#### SKL for decentralised bus modules:

- STFZ|SKL - sizes: 3 - 6 mm 1 × SKL
- STFZ2|SKL 23 1 × SKL

#### SKL for Siemens module ET 200 SP:

- STFZ-SP|SKL - sizes: 3-6 mm 1 × SKL
- STFZ2-SP|SKL 23 1 × SKL

\* Subject to alterations



Description	Order No.	PU
EMC ServiceBox	88002	1

4  
4.1  
4.2  
4.3  
4.4

# RLFZ-M | SC|RLFZ-M

## EMC Clamp assembly with strain relief and a large clamping range

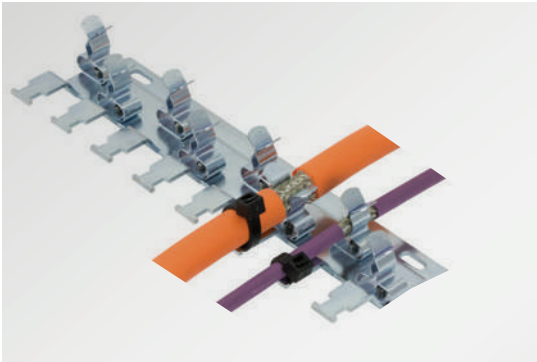

for screw mounting

The RLFZ-M range is a further development of the EMC clamp assembly which enables earthing and strain relief of up to 12 cable shields from 3-12 mm using only one shield clamp size.

There are 10 different carriers available which can be easily user configured with up to 12 MSKL 3-12 shield clamps.

### Advantages & benefits

- Easy storage due to large clamping range 3-12 mm
- Designed for high density applications
- Possibility to configure custom specific EMC clamp assemblies
- Separate strain relief and EMC shield earthing
- Online design tool for EMC Clamp assembly on [www.icotek.com](http://www.icotek.com)

### Specifications

#### Material

MSKL-clamp	Spring steel, zinc plated
RLFZ-M-foot	Sheet steel, galvanically zinc plated
SC-foot	Sheet steel, galvanically zinc plated

Type	Order No. for direct mounting	Order No. for C-rails	Number of shield clamps	Length	Width	PU
RLFZ-M (x2)	38069.002	–	2× MSKL 3-12	36 mm	54.1 mm	1
RLFZ-M (x3)	38070.002	38070.100	3× MSKL 3-12	52 mm	54.1 mm	1
RLFZ-M (x4)	38071.002	38071.100	4× MSKL 3-12	73 mm	54.1 mm	1
RLFZ-M (x5)	38072.002	38072.100	5× MSKL 3-12	94 mm	54.1 mm	1
RLFZ-M (x6)	38073.002	38073.100	6× MSKL 3-12	115 mm	54.1 mm	1
RLFZ-M (x7)	38074.002	38074.100	7× MSKL 3-12	136 mm	54.1 mm	1
RLFZ-M (x8)	38075.002	38075.100	8× MSKL 3-12	157 mm	54.1 mm	1
RLFZ-M (x9)	38076.002	38076.100	9× MSKL 3-12	178 mm	54.1 mm	1
RLFZ-M (x10)	38077.002	38077.100	10× MSKL 3-12	199 mm	54.1 mm	1
RLFZ-M (x11)	38078.002	38078.100	11× MSKL 3-12	220 mm	54.1 mm	1
RLFZ-M (x12)	38079.002	38079.100	12× MSKL 3-12	241 mm	54.1 mm	1



Type SC: Mounted on screw-foot for DIN-rail shape C



Try our EMC configurator: EMC cable shield clamps as single, double or multi solution – individually configurable for your applications on [www.icotek.com](http://www.icotek.com)



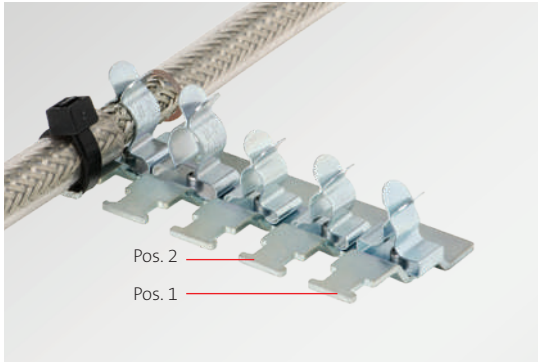

for screw mounting

The RLFZ range enables earthing and strain relief of up to 12 cables in a small space.

The combination of EMC shield earthing and strain relief is the key feature of this system.

There are 10 different carriers available which can be user configured with up to 12 SKL shield clamps.

The EMC shield clamps as listed below are available to mount:

SKL 1.5-3 | SKL 3-6 | SKL 6-8 | SKL 8-11

**Advantages & benefits**

- Designed for high density applications
- Possibility to configure custom specific EMC clamp assemblies
- Separate strain relief and EMC shield earthing
- Online design tool for EMC Clamp assembly

**Specifications**

**Material**

SKL-clamp	Spring steel, zinc plated
RLFZ-foot	Carbon steel, galvanically zinc plated
SC-foot	Carbon steel, galvanically zinc plated

Type	Order No. for direct mounting	Order No. for C-rails	Number of shield clamps	Length	Width	PU
RLFZ (x3)	38005	38005.100	3× SKL	41.2 mm	44.4 mm	1
RLFZ (x4)	38010	38010.100	4× SKL	56.8 mm	44.4 mm	1
RLFZ (x5)	38015	38015.100	5× SKL	72.4 mm	44.4 mm	1
RLFZ (x6)	38020	38020.100	6× SKL	88 mm	44.4 mm	1
RLFZ (x7)	38025	38025.100	7× SKL	103.6 mm	44.4 mm	1
RLFZ (x8)	38030	38030.100	8× SKL	119.2 mm	44.4 mm	1
RLFZ (x9)	38035	38035.100	9× SKL	134.8 mm	44.4 mm	1
RLFZ (x10)	38040	38040.100	10× SKL	150.4 mm	44.4 mm	1
RLFZ (x11)	38045	38045.100	11× SKL	166 mm	44.4 mm	1
RLFZ (x12)	38050	38050.100	12× SKL	181.6 mm	44.4 mm	1

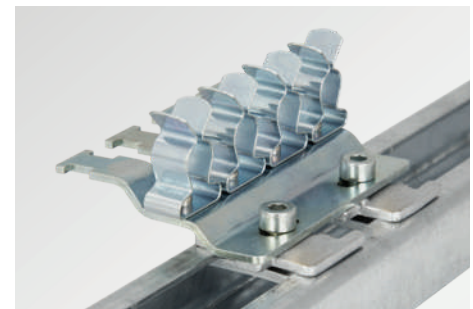

Type SC: Mounted on screw-foot for DIN-rail shape C



Try our EMC configurator: EMC cable shield clamps as single, double or multi solution – individually configurable for your applications on [www.icotek.com](http://www.icotek.com)

# SF|RLFZ

## EMC Clamp assembly for 35 mm top hat DIN rail

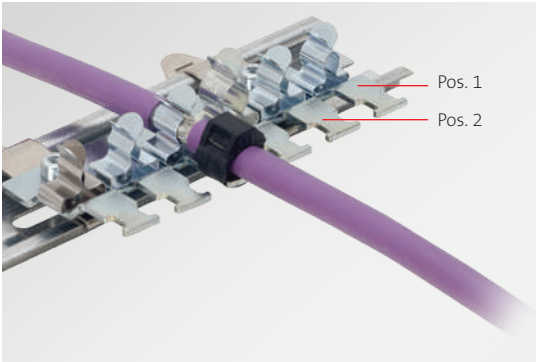

The SF|RLFZ range is based upon the RLFZ clamp assembly, which is mounted on snap feet for 35 mm top hat DIN rails.

There are 10 different carriers available, which can be user configured with up to 12 SKL shield clamps.

The EMC shield clamps as listed below are available to mount:  
SKL 1.5-3 | SKL 3-6 | SKL 6-8 | SKL 8-11

### Advantages & benefits

- Designed for high density applications
- Possibility to configure custom specific EMC clamp assemblies
- Separate strain relief and EMC shield earthing
- Simple and tool-free mounting, easy assembly
- configure online on [www.icotek.com](http://www.icotek.com)

### Specifications

#### Material

SKL-clamp	Spring steel, zinc plated
RLFZ-foot	Sheet steel, galvanically zinc plated

Type	Order No. (unfitted)	Number of shield clamps	Length	Width	PU
SF RLFZ (x3)	38105	3× SKL	41.2 mm	70.7 mm	1
SF RLFZ (x4)	38110	4× SKL	56.8 mm	70.7 mm	1
SF RLFZ (x5)	38115	5× SKL	72.4 mm	70.7 mm	1
SF RLFZ (x6)	38120	6× SKL	88 mm	70.7 mm	1
SF RLFZ (x7)	38125	7× SKL	103.6 mm	70.7 mm	1
SF RLFZ (x8)	38130	8× SKL	119.2 mm	70.7 mm	1
SF RLFZ (x9)	38135	9× SKL	134.8 mm	70.7 mm	1
SF RLFZ (x10)	38140	10× SKL	150.4 mm	70.7 mm	1
SF RLFZ (x11)	38145	11× SKL	166 mm	70.7 mm	1
SF RLFZ (x12)	38150	12× SKL	181.6 mm	70.7 mm	1



Try our EMC configurator: EMC cable shield clamps as single, double or multi solution – individually configurable for your applications on [www.icotek.com](http://www.icotek.com)

# RLF

## EMC Clamp assembly

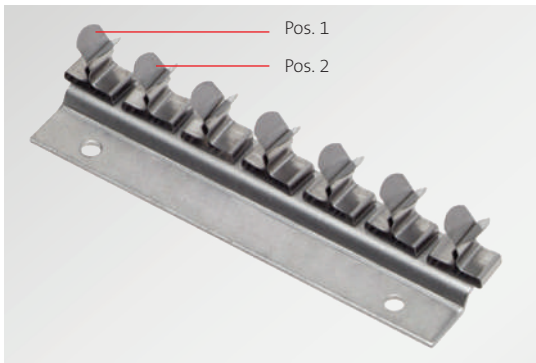

Comparable with the RLFZ clamp assembly, just without strain relief.

There are 10 different carriers available which can be user configured with up to 12 SKL shield clamps.

The EMC shield clamps as listed below are available to mount:  
SKL 1.5-3 | SKL 3-6 | SKL 6-8 | SKL 8-11

### Advantages & benefits

- Designed for high density applications
- Possibility to configure custom specific EMC clamp assemblies
- Online design tool for EMC Clamp assembly

### Specifications

<b>Material</b>	
SKL-clamp	Spring steel, zinc plated
RLF-foot	Stainless steel

Type	Order No. (unfitted)	Number of shield clamps	Length	Width	PU
RLF (x3)	36965	3× SKL	46.2 mm	24 mm	1
RLF (x4)	36984	4× SKL	60.8 mm	24 mm	1
RLF (x5)	36958	5× SKL	72.4 mm	24 mm	1
RLF (x6)	36952	6× SKL	88 mm	24 mm	1
RLF (x7)	36963	7× SKL	103.6 mm	24 mm	1
RLF (x8)	36953	8× SKL	119.2 mm	24 mm	1
RLF (x9)	36985	9× SKL	140.8 mm	24 mm	1
RLF (x10)	36954	10× SKL	150.4 mm	24 mm	1
RLF (x11)	36955	11× SKL	166 mm	24 mm	1
RLF (x12)	36962	12× SKL	181.6 mm	24 mm	1

4  
4.1  
4.2  
4.3  
4.4



Try our EMC configurator: EMC cable shield clamps as single, double or multi solution – individually configurable for your applications on [www.icotek.com](http://www.icotek.com)

# KEL-EMC-Z

## Cable assembly with strain relief

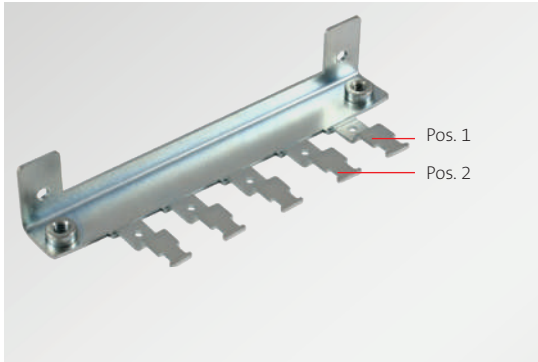

Cable entry, EMC shield earthing and strain relief – all in one location!

Cables pass through the KEL cable entry frame and lead directly to the EMC clamps and strain relief.

Simply insert the cable shield into the shield clamp and secure the cable jacket to the strain relief. Two separate functions (according to regulations) carried out quickly and easily!

Custom configurations are available for shield clamps up to 16 mm in diameter with minimal order quantities and lead time.

### Advantages & benefits

- Large surface contact between cable shield and housing, especially on conductive coated surfaces
- Sealing by outer cable jacket – EMC earthing by cable shield (in acc. with regulations)
- Easily combines cable routing, EMC and strain relief due to the use of the same mounting holes
- Available without SKL shield clamps if only additional strain relief is required
- Mounting hole for earthing tape or PE connection

### Specifications

Material Sheet steel, zinc plated

### Compatible with

KEL-FA Cable entry frames	24 - 27
KEL-U Cable entry frames	20 - 22
KEL-ER Cable entry frames	16 - 19
KEL Cable entry frames	28 - 37
KEL-QUICK Cable entry frames	95 - 107
KEL 183 Cable entry frames	38 - 39

Type	Order No.	No. of SKL	Fastening	Fits with	PU
KEL-EMC-Z 16 4	36525	4 × SKL	long side	KEL-(ER-)E4 KEL 16 x KEL-FA 16 x KEL-U 16 x KEL-ER 16 x KEL-QUICK 16	1
KEL-EMC-Z 24 5	36527	5 × SKL	long side	KEL-(ER-)E5 KEL 24 x KEL-FA 24 x KEL-U 24 x KEL-ER 24 x KEL-QUICK 24	1
KEL-EMC-Z 183 4	36528	4 × SKL	long side	KEL 183	1

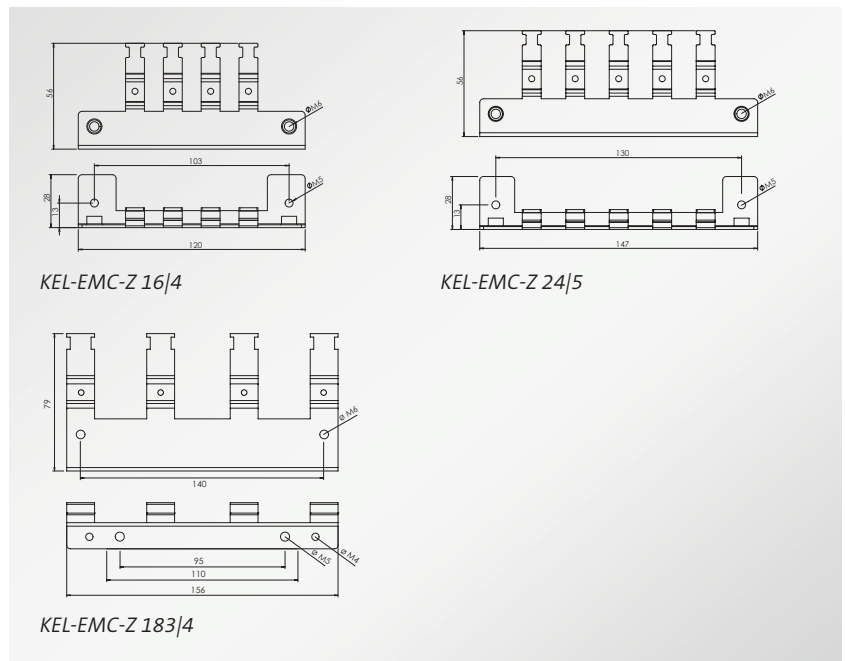

# KEL-EMC-PF

## Cable assembly, bracket version

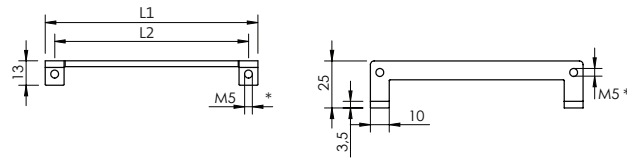

The EMC bracket combined with the matching PFS|SKL EMC shield clamp is perfect in conjunction with the KEL cable entry frame for alleviating interferences due to shields.

The EMC clamp is assembled inside the control panel. For this process the fixing screws for the assembly of the KEL frame on the panel are used. A female screw thread M5 is already integrated in the KEL-EMC-PF bracket.

Depending on the cable diameter, the corresponding PFS|SKL EMC shield clamp can be snapped onto the EMC bracket.

### Advantages & benefits

- Supports a wide range of cable and wire sizes
- Large surface contact of the cable shield
- Permanent spring pressure on the cable shield
- Fast and easy assembly

### Specifications

Material Sheet steel, galvanically zinc plated

### Compatible with

KEL-FA Cable entry frames	24 - 27
KEL-U Cable entry frames	20 - 22
KEL-ER Cable entry frames	16 - 19
KEL Cable entry frames	28 - 37
KEL 183 Cable entry frames	38 - 39
KEL-QUICK Cable entry frames	105 - 107
KEL-BES Brush frames	354 - 355
KEL-DPU Cable entry plates	144 - 147
KEL-DPZ Cable entry plates	148 - 155
PFSZ SKL / PFSZ-M MSKL Shield clamps	238
PFS SKL Shield clamps	239

Type	Fits with	Order No.	Length L1	Length L2	PU
KEL-EMC-PFM 10	KEL(-U/-ER) 10 x KEL-FA 10 x KEL-QUICK 10 x	39184	93 mm	83 mm	1
KEL-EMC-PFM 16	KEL(-U/-ER) 16 x KEL-FA 16 x KEL-QUICK 16 x KEL-DPZ 16 x	39183	113 mm	103 mm	1
KEL-EMC-PFM 24	KEL(-U/-ER) 24 x KEL-FA 24 x KEL-QUICK 24 x KEL-DPZ 24 x KEL-DPR 24 x KEL-DPU 24 x	39181	140 mm	130 mm	1
KEL-EMC-PF B4	KEL(-ER)-E2 KEL-QUICK-E2 KEL(-U)-B KEL-QUICK-B KEL-ER-B	39150	68 mm	58 mm	1
KEL-EMC-PF 10	KEL(-ER)-E3 KEL-QUICK-E3 KEL(-U/-ER) 10 x KEL-FA 10 x KEL-QUICK 10 x	39160	93 mm	83 mm	1
KEL-EMC-PF 16	KEL(-ER)-E4 KEL-QUICK-E4 KEL(-U/-ER) 16 x KEL-FA 16 x KEL-QUICK 16 x KEL-DPZ 16 x	39170	113 mm	103 mm	1
KEL-EMC-PF 24	KEL(-ER)-E5 KEL-QUICK-E5 KEL(-U/-ER) 24 x KEL-FA 24 x KEL-QUICK 24 x KEL-DPZ 24 x KEL-DPR 24 x KEL-DPU 24 x	39180	140 mm	130 mm	1
KEL-EMC-PF 183	KEL 183 KEL 183-E	39190	200 mm	95 / 190 mm	1



\* M5 thread only applies to KEL-EMV-PF

4  
4.1  
4.2  
4.3  
4.4

# KEL-EMC

## Cable assembly

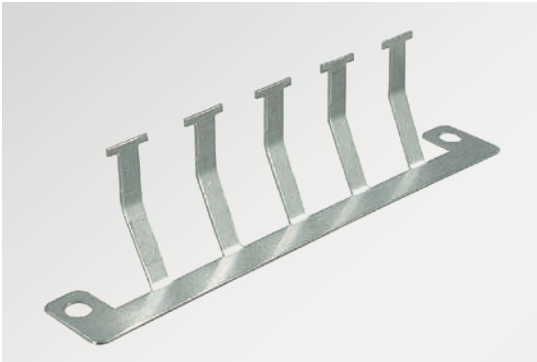

Installation of pre-terminated cables without shield interruption.

### Advantages & benefits

- Direct, easy and quick contact to the enclosure
- Space saving, usable for up to 10 cables with the two row model
- Alternative to EMC cable glands, even for pre-terminated cables
- Low resistance shield contact

### Specifications

Material Stainless steel

### Compatible with

KEL-FA Cable entry frames	24 - 27
KEL-U Cable entry frames	20 - 22
KEL-ER Cable entry frames	16 - 19
KEL Cable entry frames	28 - 37
KEL-QUICK Cable entry frames	105 - 107
KEL-BES Brush frames	354 - 455

Type	Order No.	No. of teeth	Fastening	Fits with	PU
KEL-EMC-B	36520	2	long side	KEL-E2 KEL(-U)-B x KEL-ER-B x KEL-QUICK-B2   B4	5
KEL-EMC 10	36522	3	long side	KEL-E3 KEL-FA 10 x KEL(-U) 10 x KEL-ER 10 x	5
KEL-EMC 16 4	36524	4	long side	KEL-E4 KEL-FA 16 x KEL(-U) 16 x KEL-ER 16 x KEL-QUICK 16	5
KEL-EMC 24 5	36526	5	long side	KEL-E5 KEL-FA 16 x KEL(-U) 24 x KEL-ER 24 x KEL-QUICK 24	5
KEL-EMC F	39110	3	long side	KEL(-U/-ER)-B x KEL(-U/-ER) 10 x KEL-FA 10 x KEL(-U/-ER) 16 x KEL-FA 16 x KEL(-U/-ER) 24 x KEL-FA 24 x	5

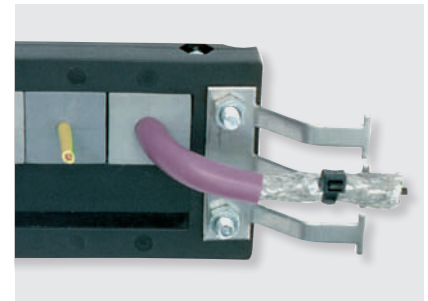
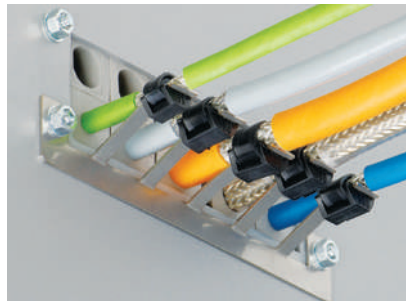

# KVT-EMC

## EMC bracket for cable glands

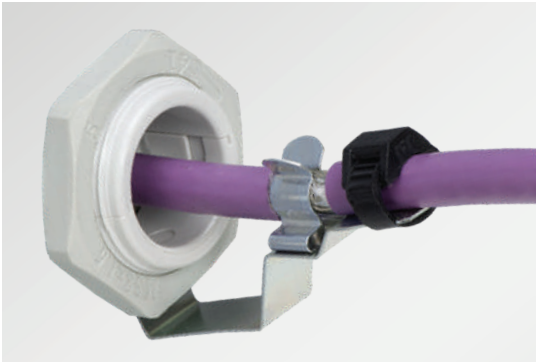

The KVT-EMC brackets in combination with the split cable glands KVT and QVT combine routing, EMC shield earthing and strain relief. The connection to the earth potential is possible via the enclosure wall or an earthing tape.

Cables pass through the split cable glands and lead directly into the EMC clamps.

Separate functions (according to regulations) carried out quickly and easily!

### Advantages & benefits

- Simple and tool-free assembly
- Large contact area
- retrofitting possible
- Additional M5 hole for earthing tape

### Specifications

Material                      Sheet steel, zinc plated

### Compatible with

KVT Split cable glands              62 - 63  
 QVT Split cable glands              109 - 110

Type	Fits with	Order No.		Shield diameter	PU
KVT-EMC-16 SKL 1.5-3	QVT 16	37187.1		1.5 – 3 mm	5
KVT-EMC-16 SKL 3-6	QVT 16	37187.2		3 – 6 mm	5
KVT-EMC-16 SKL 6-8	QVT 16	37187.3		6 – 8 mm	5
KVT-EMC-16 SKL 8-11	QVT 16	37187.4		8 – 11 mm	5
KVT-EMC-20 SKL 1.5-3	KVT 20 QVT 20	37190.1	<b>NEW</b>	1.5 – 3 mm	5
KVT-EMC-20 SKL 3-6	KVT 20 QVT 20	37190.2	<b>NEW</b>	3 – 6 mm	5
KVT-EMC-20 SKL 6-8	KVT 20 QVT 20	37190.3	<b>NEW</b>	6 – 8 mm	5
KVT-EMC-20 SKL 8-11	KVT 20 QVT 20	37190.4	<b>NEW</b>	8 – 11 mm	5
KVT-EMC-25 SKL 1.5-3	KVT 25 QVT 25	37180.1		1.5 – 3 mm	5
KVT-EMC-25 SKL 3-6	KVT 25 QVT 25	37180.2		3 – 6 mm	5
KVT-EMC-25 SKL 6-8	KVT 25 QVT 25	37180.3		6 – 8 mm	5
KVT-EMC-25 SKL 8-11	KVT 25 QVT 25	37180.4		8 – 11 mm	5
KVT-EMC-32 SKL 1.5-3	KVT 32 QVT 32	37181.1		1.5 – 3 mm	5
KVT-EMC-32 SKL 3-6	KVT 32 QVT 32	37181.2		3 – 6 mm	5
KVT-EMC-32 SKL 6-8	KVT 32 QVT 32	37181.3		6 – 8 mm	5
KVT-EMC-32 SKL 8-11	KVT 32 QVT 32	37181.4		8 – 11 mm	5



4  
 4.1  
 4.2  
 4.3  
 4.4

# KAFM-EMC

## EMC Strain relief plates

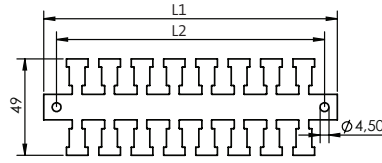
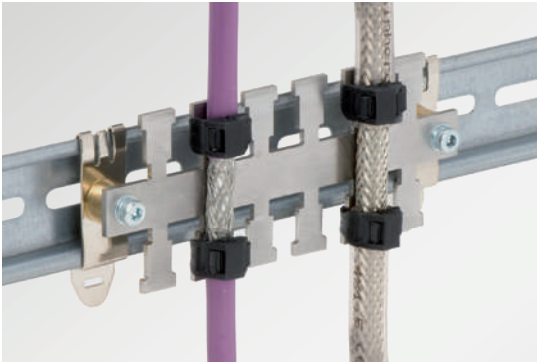

The EMC strain relief plate KAFM is practical for earthing interferences on the cable shield.

The cable assembly can be assembled on a mounting plate with screws, with SC foot on DIN-rails shape C or with SF or SK mounting foot on 35 mm top hat DIN-rails.

### Specifications

Material      Stainless steel

Type	Order No. Type SF	Order No. Type SK	Order No. Type SC	Order No. Type DH	Order No. loose rail	Length L1	Length L2	No. of teeth	PU
KAFM 2	36442	36432	36412	36482	36422	50.5	37.5	2	1
KAFM 4	36444	36434	36414	36484	36424	83.5	70.5	4	1
KAFM 6	36446	36436	36416	36486	36426	116.5	103.5	6	1
KAFM 8	36448	36438	36418	36488	36428	149.5	136.5	8	1
KAFM 10	36450	36440	36400	36490	36430	182.5	169.5	10	1
KAFM 16	36452	36470	36465	36460	36530	281.5	268.5	16	1
KAFM 29	36454	36471	36466	36462	36540	494.5	481.5	29	1
KAFM 59	36458	36472	36467	36464	36550	990	978	59	1
KAFM 59 zinc plated	36459	-	-	-	36562	990	978	59	1
SF	36230	Mounting foot single, for 35 mm top hat DIN-rail							10
SK	36232	Screw-foot single, for 35 mm top hat DIN-rail							10
SC	36231	Screw-foot single, for 30 mm DIN-rail shape C (width of mouth: 16–17 mm) with twist protection notch							10
Bushing DH	36234	Distance bushing 8 mm high							10



Type SF: Mounted on snap foot for top hat DIN-rail

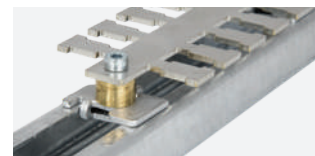

Type SC: Mounted on screw-foot for DIN-rail shape C



Type SK: Mounted on screw-foot for top hat DIN-rail



Type DH: Mounted on bushing for flexible fixation on bottom sheet



# ZL|SB-EMC

## Shield plate for ZL strain relief plates



The shield plates ZL|SB-EMC provide shield earthing in addition to strain relief.

Affix the corresponding shield plates to ZL strain relief plates. The shield plate contacts the cable shield with the earth potential.

The result is a secure low resistance connection between cable shield and earth.

ZL strain relief plates offered separately.

### Specifications

Material  
Shield plate            Stainless steel

### Compatible with

SF|ZL Strain relief plates            236 - 237  
ZL Strain relief plates                194  
ZL-AB Strain relief plates            195

Type	Model	Order No.	Fits with	Length L1	Length L2	PU
ZL 39 SB-EMC-1	single-row	36322	ZL 39	42 mm	19.5 mm	10
ZL 39 SB-EMC-2	double-row	37150	ZL 39	42 mm	19.5 mm	10
ZL 60 SB-EMC-1	single-row	36328	ZL 60	64 mm	43.5 mm	10
ZL 60 SB-EMC-2	double-row	37152	ZL 60	64 mm	43.5 mm	10
ZL 70 SB-EMC-1	single-row	36323	ZL 70	72.2 mm	43.5 mm	10
ZL 87 SB-EMC-1	single-row	36324	ZL 87	90 mm	68 mm	10
ZL 87 SB-EMC-2	double-row	37154	ZL 87	90 mm	68 mm	10
ZL 103 SB-EMC-1	single-row	36332	ZL 103	106 mm	84 mm	10
ZL 103 SB-EMC-2	double-row	37156	ZL 103	106 mm	84 mm	10
ZL 121 SB-EMC-1	single-row	36330	ZL 121	124 mm	102.5 mm	10
ZL 121 SB-EMC-2	double-row	37158	ZL 121	124 mm	102.5 mm	10
ZL 140 SB-EMC-1	single-row	36326	ZL 140	142 mm	121 mm	10
ZL 140 SB-EMC-2	double-row	37159	ZL 140	142 mm	121 mm	10

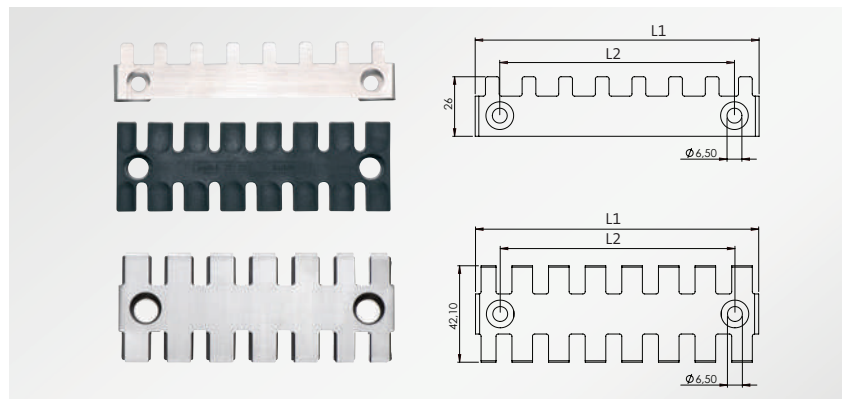

4  
4.1  
4.2  
4.3  
4.4

# MB

## Earthing tapes



Manufactured with highly flexible E-Cu stranded wires with connecting end pads made of tinned copper strips.

The minimum transition and connecting resistance makes them perfectly suitable for use as earthing tapes.

Earthing Tapes are available with M4, M5, M6, M8 or M10 connections and in some sizes with both connection sizes combined.

Type	Order No.	Distance L [mm]	Cross-section mm <sup>2</sup>	Hole size	PU
<b>Cross-section 6 mm<sup>2</sup></b>					
MB 100   6   M4	32695	100	6	M4	1
MB 100   6   M6	32700	100	6	M6	1
MB 150   6   M4	39710	150	6	M4	1
MB 150   6   M6	32701	150	6	M6	1
MB 200   6   M4	32707	200	6	M4	1
MB 200   6   M6	32702	200	6	M6	1
MB 250   6   M6	32706	250	6	M6	1
MB 300   6   M6	32703	300	6	M6	1
MB 400   6   M6	32704	400	6	M6	1
MB 500   6   M6	32705	500	6	M6	1
<b>Cross-section 10 mm<sup>2</sup></b>					
MB 100   10   M6	32730	100	10	M6	1
MB 100   10   M6 + M4	39711	100	10	M6 + M4	1
MB 100   10   M8	32731	100	10	M8	1
MB 150   10   M5	32709	150	10	M5	1
MB 150   10   M5 + M6	32746	150	10	M5 + M6	1
MB 150   10   M8	32732	150	10	M8	1
MB 200   10   M5	32744	200	10	M5	1
MB 200   10   M6	32733	200	10	M6	1
MB 200   10   M6 + M8	32741	200	10	M6 + M8	1
MB 200   10   M8	32734	200	10	M8	1
MB 250   10   M6 + M8	32742	250	10	M6 + M8	1
MB 300   10   M6	32735	300	10	M6	1
MB 300   10   M6 + M8	32743	300	10	M6 + M8	1
MB 300   10   M8	32736	300	10	M8	1
MB 400   10   M4	32878	400	10	M4	1
MB 400   10   M6	32737	400	10	M6	1
MB 400   10   M8	32738	400	10	M8	1
MB 500   10   M6	32739	500	10	M6	1

# MB

## Earthing tapes



Connecting end pads (copper)

### Advantages & benefits

- Available in a variety of lengths and cross-sections
- Low impedances
- UL 467 listed

### Specifications

Material            Cu-ETP with connecting end pads  
 Pads made of tinned copper strips

### Current Load

Cross-section	Current load
6 mm <sup>2</sup>	67 – 80 A
10 mm <sup>2</sup>	89 – 106 A
16 mm <sup>2</sup>	132 – 157 A
25 mm <sup>2</sup>	177 – 210 A
35 mm <sup>2</sup>	230 – 275 A
50 mm <sup>2</sup>	280 – 350 A
70 mm <sup>2</sup>	338 – 403 A

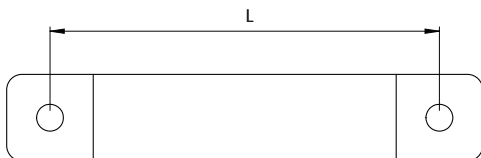

Type	Order No.	Distance L [mm]	Cross-section mm <sup>2</sup>	Hole size	PU
<b>Cross-section 16 mm<sup>2</sup></b>					
MB 100   16   M6	32760	100	16	M6	1
MB 100   16   M6 + M8	32758	100	16	M6 + M8	1
MB 100   16   M8	32761	100	16	M8	1
MB 100   16   M10	32759	100	16	M10	1
MB 150   16   M6	32762	150	16	M6	1
MB 150   16   M8	32763	150	16	M8	1
MB 200   16   M6	32764	200	16	M6	1
MB 200   16   M5 + M6	32776	200	16	M5 + M6	1
MB 200   16   M6 + M8	32773	200	16	M6 + M8	1
MB 200   16   M8	32765	200	16	M8	1
MB 250   16   M8	32766	250	16	M8	1
MB 250   16   M6 + M8	32774	250	16	M6 + M8	1
MB 300   16   M6	32767	300	16	M6	1
MB 300   16   M6 + M8	32775	300	16	M6 + M8	1
MB 300   16   M8	32768	300	16	M8	1
MB 350   16   M8	32769	350	16	M8	1
MB 350   16   M5 + M6	32777	350	16	M5 + M6	1
MB 400   16   M6	32873	400	16	M6	1
MB 400   16   M8	32770	400	16	M8	1
MB 500   16   M8	32771	500	16	M8	1
MB 600   16   M8	32772	600	16	M8	1
MB 1000   16   M8	32778	1000	16	M8	1
<b>Cross-section 25 mm<sup>2</sup></b>					
MB 100   25   M10	32800	100	25	M10	1
MB 150   25   M10	32801	150	25	M10	1
MB 200   25   M8	32802	200	25	M8	1
MB 200   25   M10	32803	200	25	M10	1
MB 250   25   M8	32804	250	25	M8	1
MB 250   25   M10	32805	250	25	M10	1

4  
4.1  
4.2  
4.3  
4.4

# MB

## Earthing tapes



Manufactured with highly flexible E-Cu stranded wires with connecting end pads made of tinned copper strips.

The minimum transition and connecting resistance makes them perfectly suitable for use as earthing tapes.

Earthing Tapes are available with M4, M5, M6, M8 or M10 connections and in some sizes with both connection sizes combined.

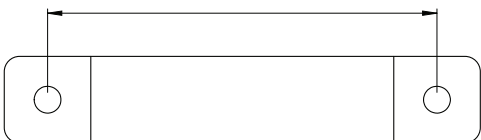

Type	Order No.	Distance L [mm]	Cross-section mm <sup>2</sup>	Hole size	PU
<b>Cross-section 25 mm<sup>2</sup></b>					
MB 300   25   M8	32806	300	25	M8	1
MB 300   25   M10	32807	300	25	M10	1
MB 300   25   M6	32816	<b>NEW</b> 300	25	M6	1
MB 300   25   M8 + M10	32817	<b>NEW</b> 300	25	M8 + M10	1
MB 350   25   M10	32808	350	25	M10	1
MB 400   25   M8	32809	400	25	M8	1
MB 500   25   M8	32810	500	25	M8	1
MB 500   25   M10	32812	500	25	M10	1
MB 600   25   M8	32811	600	25	M8	1
MB 800   25   M8	32815	800	25	M8	1
<b>Cross-section 35 mm<sup>2</sup></b>					
MB 200   35   M10	32823	200	35	M10	1
MB 250   35   M10	32824	250	35	M10	1
MB 300   35   M10	32825	300	35	M10	1
MB 400   35   M8	32886	<b>NEW</b> 400	35	M8	1
<b>Cross-section 50 mm<sup>2</sup></b>					
MB 150   50   M10	32847	150	50	M10	1
MB 200   50   M10	32848	200	50	M10	1
MB 250   50   M10	32849	250	50	M10	1
MB 300   50   M10	32850	300	50	M10	1
<b>Cross-section 70 mm<sup>2</sup></b>					
MB 200   70   M10*	32868	200	70	M10	1
MB 300   70   M10*	32870	300	70	M10	1
MB 500   70   M10*	32872	500	70	M10	1

# EMC

## Customised solutions

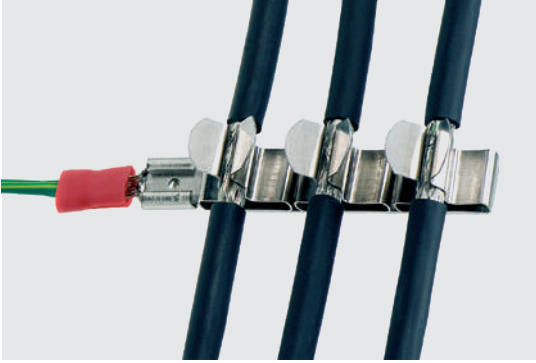

In addition to our standard product offering we offer customised solutions for your application – even for small quantities!

A wide range of standard clamp assemblies are already available (see pages 256 - 259).

If a standard EMC clamp assembly is not practicable in your case, a custom designed carrier for shield clamps can be supplied.

We look forward to sharing our ideas and custom EMC solutions with you.

### Advantages & benefits

- Supply of custom designed carriers for SKL shield clamps
- Cost-effective even for small quantities
- Available for a wide range of cable diameters

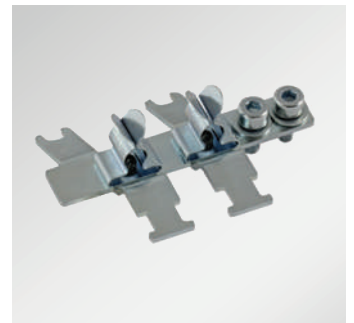
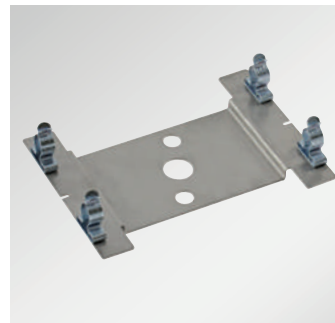
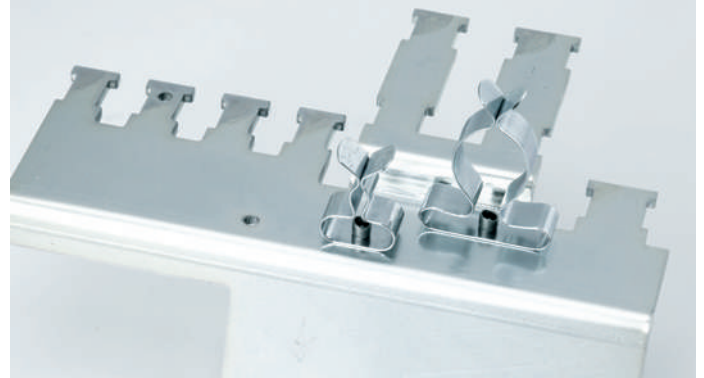

 Contact us: [pm@icotek.com](mailto:pm@icotek.com)

4  
4.1  
4.2  
4.3  
4.4

## 4.2 – 4.4 EMC cable entry systems

### Solutions for conducted and field-bound disturbances



**The industrial process technology demands increasing security against disturbances for electrical MCR facilities (measure, control, regulate). Special emphasis is being placed on the derivation of electromagnetic interference. A distinction is made between screening-related and field-related disturbances.**

Screening-related interference is being transmitted directly from the source of interference to the cable shield of the supply or signal leads and then to the susceptible device. All capacitive and inductive influences of electrical or magnetic fields are called field bound disturbances. The field bound disturbances are being transferred, for example as a cable's electromagnetic field, from the source of interference to the susceptible device and received there, for instance, by a head acting as an antenna.

A large contact area of the cable shield for the derivation of the interference to a conductive housing wall combined with the shielding of the housing interior generally offers a good solution for both types of interference.

In case of conducted as well as field bound EMC disturbances, our cable entry system offers an effective way to divert and block those disturbances.

The key feature of icotek's system is the split frame and split grommets which provide quick, convenient and cost effective routing of pre-terminated and multi-conductor cables, hoses and conduits. The split frame and split grommets alleviate the need to cut and re-wire pre-terminated cables. Therefore, cable warranties are unaffected.

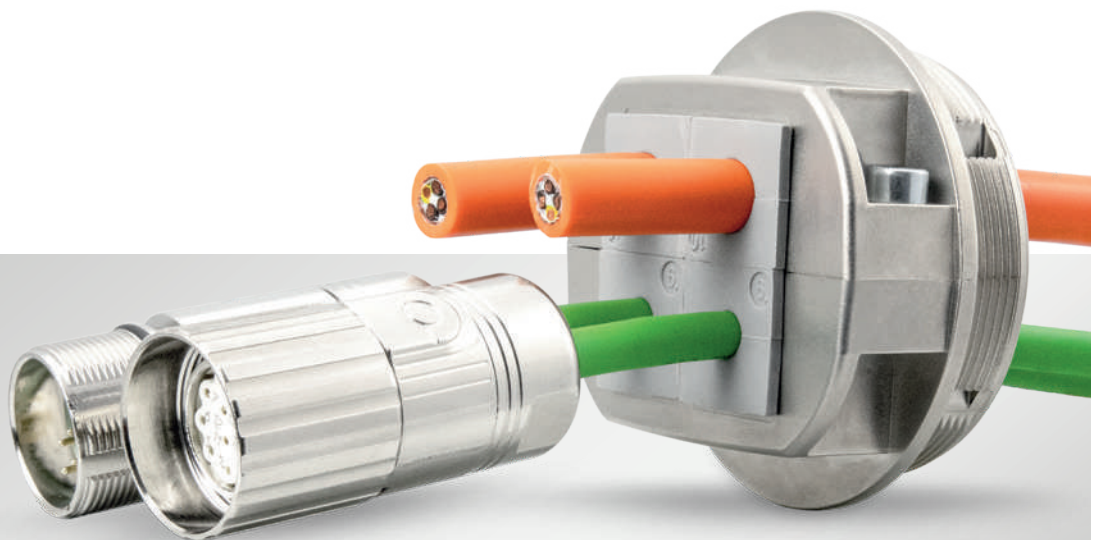

## Test results: Conducted and field-bound disturbances

### Conducted disturbances

The EMC-KEL shows during cable-bound disruptions stable attenuation values up to 40 dB in the frequency ranges from 9 kHz to 30 MHz.

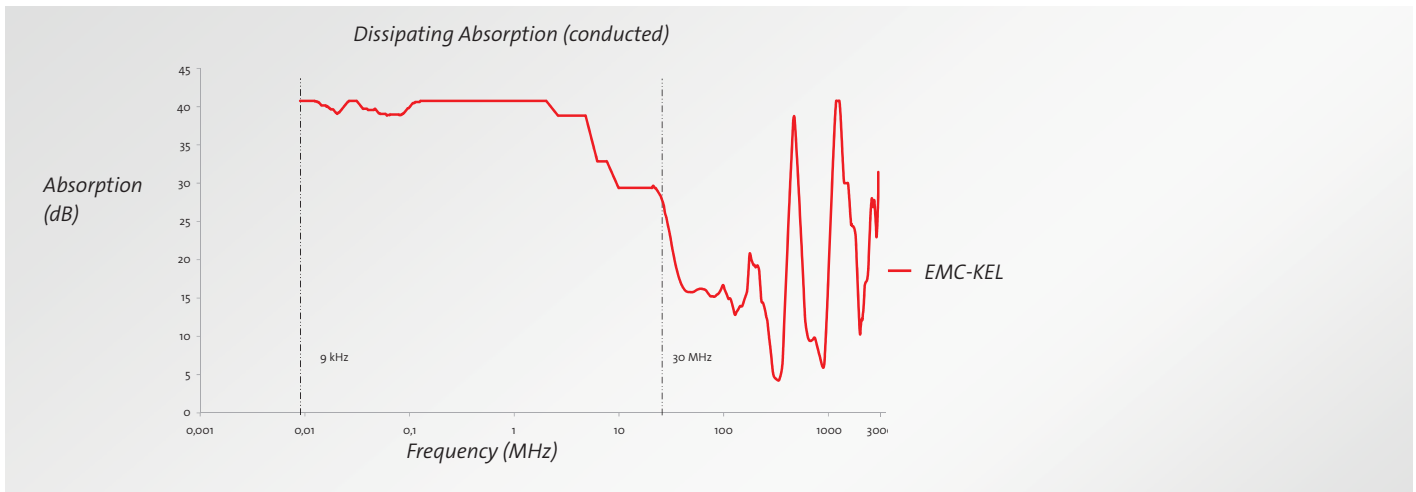
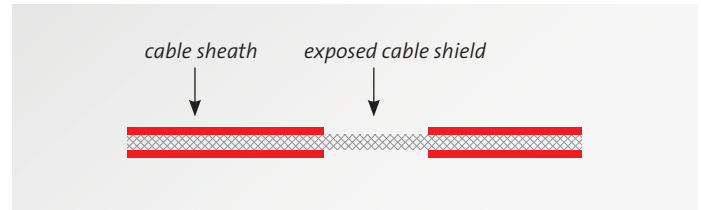

### Field-bound disturbances

Regarding the field-bound disturbances and depending on the application, in the relevant frequency ranges up to 3 GHz constant measurements of at least 34 dB have been achieved. Below the attenuation range, the curve falls only at extreme high frequencies above 3 GHz.

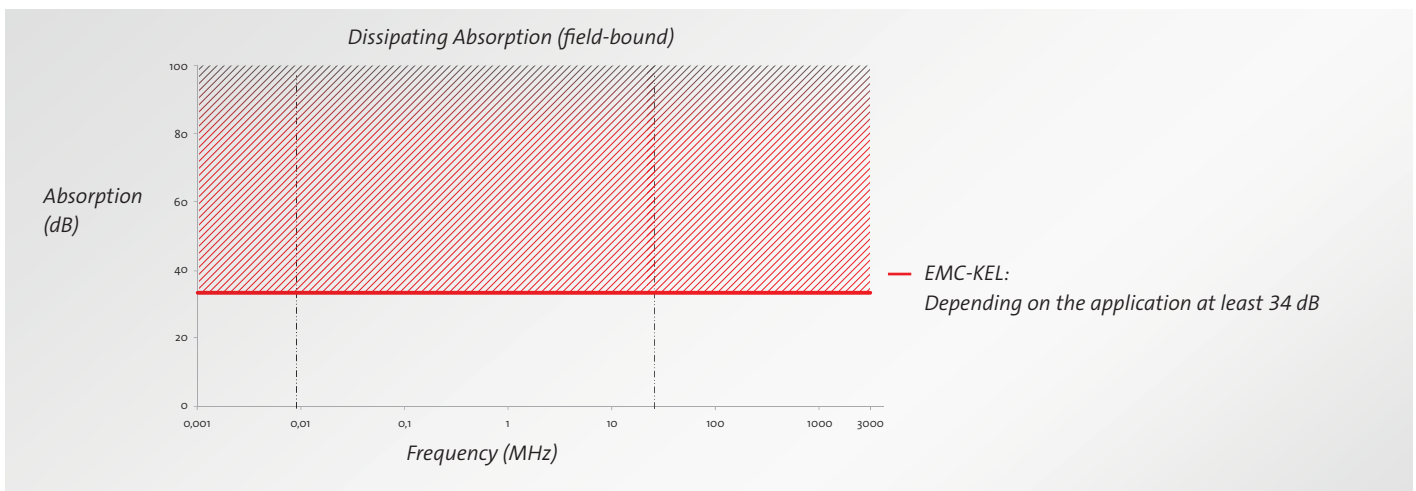

- 4
- 4.1
- 4.2
- 4.3
- 4.4

## 4.2 – 4.4 EMC cable entry systems

Solutions for conducted and field-bound disturbances

Space saving icotek solution:  
EMC cable entry frame  
EMC-KEL-DS 24|10

normal EMC cable glands

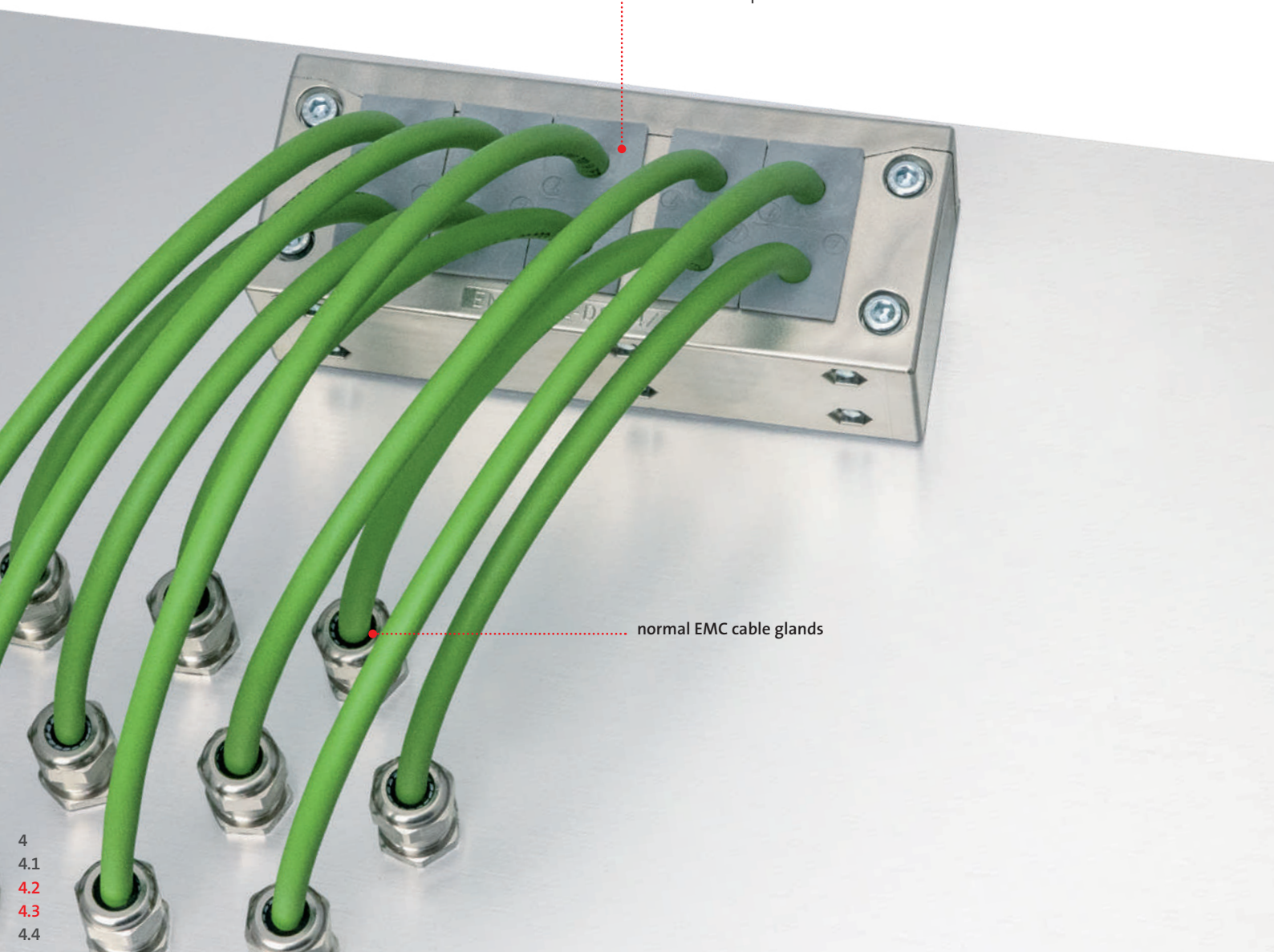

4  
4.1  
4.2  
4.3  
4.4



## EMC Split cable entry frames



EMC Split cable entry frames  
for cable diameters 2 to 33 mm

EMC-KEL-DS

274 – 275



EMC Split cable entry frames  
for cable diameters 2 to 33 mm

EMC-KEL

276 – 277

## EMC Split cable gland

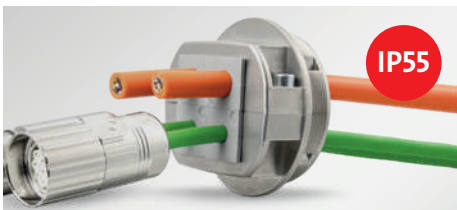

EMC Split cable gland  
for screw-in assembly, M32, M63  
for cable diameters 2 to 33 mm

EMC-KVT-DS

278 – 279

## Split EMC grommets

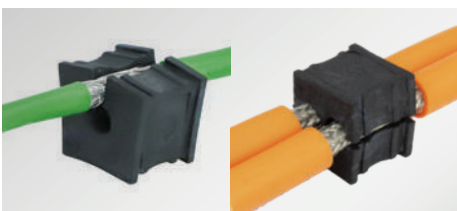

Split EMC grommets  
small, single and multi  
for cables with and without connectors  
for cable diameters 2 to 16 mm

EMC-KT

280

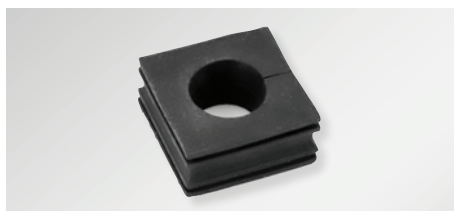

Split EMC grommets  
large, single  
for cables with and without connectors  
for cable diameters 13 to 33 mm

EMC-KT

281



KT cable grommets  
split,  
for cables with and without connectors  
for cable diameters 1 – 35 mm

76, 80

4  
4.1  
4.2  
4.3  
4.4

The EMC cable entry frame EMC-KEL-DS has been metallised (galvanise coated) to create a conductive surface.

The front cable grommet (A) is used for strain relief and cable sealing on the cable jacket. The cable shield is contacted over 360° via the rear conductive grommet (B).

The contact between the EMC-KEL-DS and the conductive housing wall is realised via the included conductive flat gasket.

### Advantages & benefits

- Perfect for already pre-terminated cables. The connector does not have to be removed for wiring
- Strain relief and sealing are separated from the EMC contact
- Both conducted and field-bound disturbances are reliably diverted
- Very attractive and scratch-resistant surface
- Contacting the cable shield over 360°
- EMC grommets made entirely from conductive elastomer
- Very good dissipation values
- Very good shielding effect with regard to EMC tightness
- Integrated strain relief
- Protection class IP55
- High cable density with multi grommets

### Specifications

Material	Polyamide, highly conductive coating
Flame class	acc. to UL 94 HB
Temperature	-40°C to + 140°C
Properties	Halogen free, silicone free
Frame depth	40 mm
IP rating	IP55

### Accessories

EMC-KT grommets	280 - 281
KT grommets	76 - 77

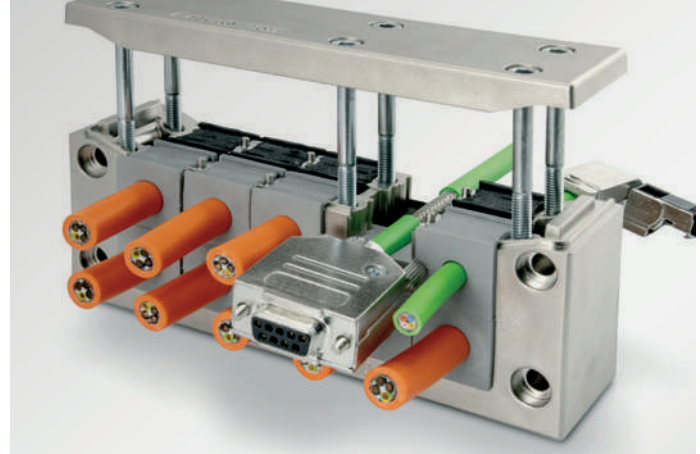

Front



Reverse

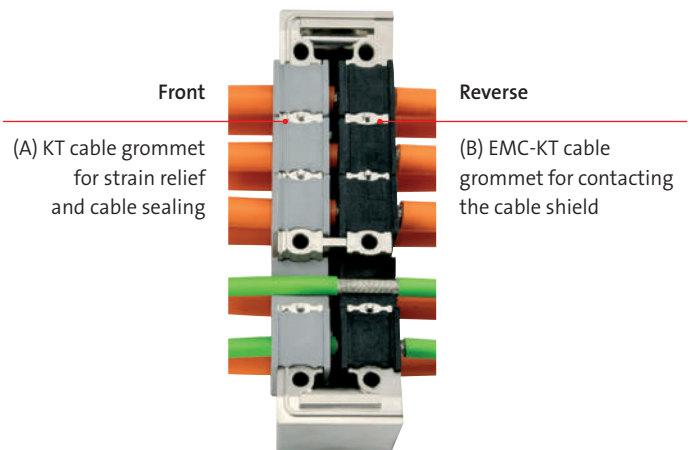

# EMC-KEL-DS

## EMC Cable entry frames



Description	Cut-out   Drilling template	Type	Order No.	Cut-out mm	KT Grommets small   large	EMC grommets small   large	PU
		EMC-KEL-DS 24 10	99410	112 × 36 mm	10   -	10   -	1
		EMC-KEL-DS 24 10 with threaded bushings M4	99410.400				
		EMC-KEL-DS 24 7	99411	112 × 36 mm	6   1	6   1	1
		EMC-KEL-DS 24 7 with threaded bushings M4	99411.400				
		EMC-KEL-DS 24 4	99412	112 × 36 mm	2   2	2   2	1
		EMC-KEL-DS 24 4 with threaded bushings M4	99412.400				
		EMC gasket size 24 conductive gasket for EMC-KEL-DS	98047	112 × 36 mm	-	-	1



4  
4.1  
**4.2**  
4.3  
4.4

# EMC-KEL

## EMC Cable entry frames

The EMC cable entry frames EMC-KEL are based on the KEL-U and KEL-E. Due to a conductive surface, disturbances in the cable shields on the control cabinet can be easily dissipated. Field bound disturbances are derived by the metallisation.

The cable entry system is easy to install. Cable grommets are placed into compartments and are securely fixed to the frame during assembly.

The EMC-KEL-U frames match exactly the cut-out dimensions for 16- and 24-pin standard industrial connectors. Either a cut-out of 36 mm or 46 mm in height can be chosen depending on the cables being routed.

The single-row versions EMC-KEL-E are particularly suited for flat connectors. The small frames are ideal for applications with limited space.

Between the EMC-KEL and the metal wall a conductive flat gasket (included) is mounted. The flange surface on the metal wall must be free of paint.

### Advantages & benefits

- Both conducted and field-bound disturbances can be reliably diverted
- Very attractive and scratch-resistant surface
- Contacting the cable shield over 360°
- Grommets made entirely from conductive elastomer
- High cable density
- Very good dissipation values
- Very good shielding effect with regard to EMC tightness

### Specifications

Material	Polyamide, highly conductive coating
Flame class	UL 94 HB
Temperature	-40°C to + 140°C
Properties	Halogen free, silicone free
Frame depth	17 mm

### Accessories

EMC-KT grommets 280 - 281



# EMC-KEL

## EMC Cable entry frames



Description	Cut-out	Type	Order No.	Cut-out	Grommets EMC-KT small   large	PU
		EMC-KEL-U 24 10	99400	36 × 112 mm	10   –	1
		EMC-KEL-U 24 4	99401	36 × 112 mm	2   2	1
		EMC-KEL-U 16 8	99402	36 × 86 mm	8   –	1
		EMC-KEL-E3	99420	24 × 65 mm	3   –	1
		EMC-KEL-E5	99422	24 × 112 mm	5   –	1
		EMC gasket size 24, conductive gasket	98047	36 × 112 mm	–	1

4  
4.1  
4.2  
4.3  
4.4

# EMC-KVT-DS

## EMC Split cable gland

IP55

The split cable gland EMC-KVT-DS is based on the standard icotek KVT product. However, the EMC-KVT-DS has been metallised (galvanise coated) to create a conductive surface.

The first cable grommet (KT small) is used for strain relief and cable sealing on the cable jacket. The second grommet (EMC-KT small) contacts the cable shield at a full 360 degrees.

The conductive flat gasket included in the scope of delivery makes contact between the cable gland and the conductive housing wall. The EMC-KVT-DS can thus be fixed using a plastic lock nut. Alternatively, an additional contact to the metal wall can be made using a special EMC lock nut.

### Advantages & benefits

- Perfect for already pre-terminated cables. The connector does not have to be removed for wiring
- Strain relief and sealing are separated from the EMC contact
- Both conducted and field-bound disturbances are reliably diverted
- Very attractive and scratch-resistant surface
- Contacting the cable shield over 360°
- EMC grommets made entirely from conductive elastomer
- Very good dissipation values
- Very good shielding effect with regard to EMC tightness
- Integrated strain relief
- Protection class IP55
- High cable density

### Specifications

Material	Polycarbonate (PC), highly conductive coating
EMC locknut	Nickel-plated brass
Flame class	acc. to UL 94 HB
Temperature	-30°C to +90°C
Properties	Halogen free, silicone free
IP rating	IP55

### Accessories

KT grommets	76 - 77
EMC-KT grommets	280 - 281
KGM	346



EMC locknut

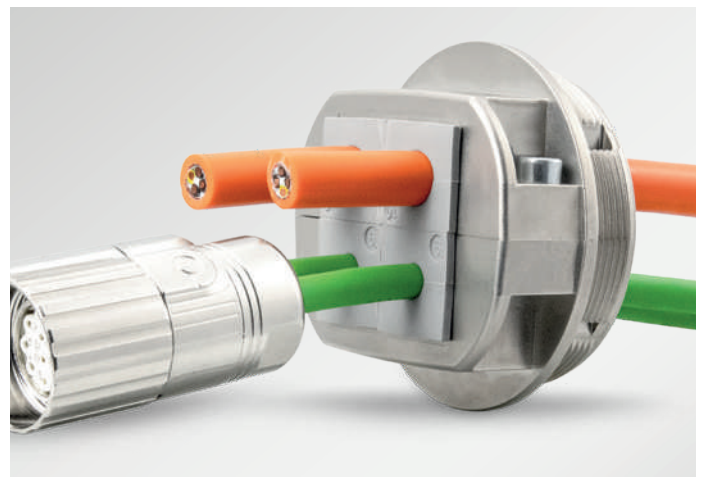

Front Reverse  
 KT cable grommet for strain relief and cable sealing  
 EMC-KT cable grommet for contacting the cable shield

# EMC-KVT-DS

## EMC Split cable gland



Description	Type	Order No.	KT Grommets small   large	EMC grommets small   large	Thread Thread length	PU
	EMC-KVT-DS 32 with plastic lock nut KGM 32	99431	1   -	1   -	M32 x 1.5 Length 14 mm	5
	EMC-KVT-DS 32 with EMC lock nut EMC-GM 32 Nickel-plated brass	99432	1   -	1   -	M32 x 1.5 Length 14 mm	5
	EMC-KVT-DS 63 1 with plastic lock nut KGM 63	99434	-   1	-   1	M63 x 1.5 Length 14 mm	1
	EMC-KVT-DS 63 1 with EMC lock nut EMC-GM 63 Nickel-plated brass	99435	-   1	-   1	M63 x 1.5 Length 14 mm	1
	EMC-KVT-DS 63 4 with plastic lock nut KGM 63	99436	4   -	4   -	M63 x 1.5 Length 14 mm	1
	EMC-KVT-DS 63 4 with EMC lock nut EMC-GM 63 Nickel-plated brass	99437	4   -	4   -	M63 x 1.5 Length 14 mm	1
	EMC-GM 32 EMC lock nut M32 for EMC-KVT-DS 32 Nickel-plated brass	99557	-	-	-	5
	EMC-GM 63 EMC lock nut M63 for EMC-KVT-DS 63 Nickel-plated brass	99558	-	-	-	1
	EMC gasket 32 conductive gasket for EMC-KVT-DS 32	99555	-	-	-	1
	EMC gasket 63 conductive gasket for EMC-KVT-DS 63	99556	-	-	-	1

4  
4.1  
4.2  
4.3  
4.4

# EMC-KT

## Split EMC grommets, small, single, multi

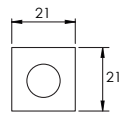

EMC-KT small



The cable grommets type EMC-KT are made of a very conductive elastomer. Thus, disturbances are dissipated from the cable shield directly via the grommet, the frame and the flat gasket. This ensures full-area protection against field-bound interference!

The model range EMC-KT small is designed for cable diameters from 2 to 16 mm. Cable grommets EMC-KT large accept a wide range of cable diameters from 13 to 33 mm.

When installing the small grommets in multiple rows, the flat sides should be facing each other.

### Advantages & benefits

- Contacting the cable shield over 360°
- EMC grommets made entirely from conductive elastomer
- Enable routing of pre-terminated cables through cable entry frames and split cable glands
- Available for a large range of cable diameters













### Specifications

Material	Elastomer, conductive
Flame class	in accordance with UL94-HB
Colour	black
operatin temperature	-30°C to +80°C -22°F to +176°F
Properties	Halogen free, silicone free

### Accessories

ST Plugs 85

KT grommets can be found from page 76 on.

Description	Type	Order No.	Clamping range on the cable shield	PU
	EMC-KT 2	99459	2 – 3 mm	5
	EMC-KT 3	99460	3 – 4 mm	5
	EMC-KT 4	99461	4 – 5 mm	5
	EMC-KT 5	99462	5 – 6 mm	5
	EMC-KT 6	99463	6 – 7 mm	5
	EMC-KT 7	99464	7 – 8 mm	5
	EMC-KT 8	99465	8 – 9 mm	5
	EMC-KT 9	99466	9 – 10 mm	5
	EMC-KT 10	99467	10 – 11 mm	5
	EMC-KT 11	99468	11 – 12 mm	5
	EMC-KT 12	99469	12 – 13 mm	5
	EMC-KT 13	99470	13 – 14 mm	5
	EMC-KT 14	99471	14 – 15 mm	5
	EMC-KT 15	99472	15 – 16 mm	5
	EMC-BTK	99473	blank grommet	5
	EMC-KT 2 2	99500	2× ø 2 mm	5
	EMC-KT 2 3	99501	2× ø 3 mm	5
	EMC-KT 2 4	99493	2× ø 4 mm	5
	EMC-KT 2 5	99502	2× ø 5 mm	5
	EMC-KT 2 6	99503	2× ø 6 mm	5
	EMC-KT 4 2	99504	4× ø 2 mm	5
	EMC-KT 4 3	99505	4× ø 3 mm	5
	EMC-KT 4 4	99506	4× ø 4 mm	5
	EMC-KT 4 5	99507	4× ø 5 mm	5



# EMC-KT

## Split EMC grommets, large, single

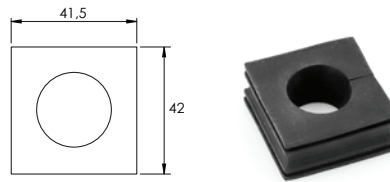

EMC-KT large

The cable grommets type EMC-KT are made of a very conductive elastomer. Thus, disturbances are dissipated from the cable shield directly via the grommet, the frame and the flat gasket. This ensures full-area protection against field-bound interference!

The model range EMC-KT small is designed for cable diameters from 2 to 16 mm. Cable grommets EMC-KT large accept a wide range of cable diameters from 13 to 33 mm.

When installing the small grommets in multiple rows, the flat sides should be facing each other.

### Advantages & benefits

- Contacting the cable shield over 360°
- EMC grommets made entirely from conductive elastomer
- Enable routing of pre-terminated cables through cable entry frames and split cable glands
- Available for a large range of cable diameters

### Specifications

Material	Elastomer, conductive
Flame class	in accordance with UL94-HB
Colour	black
Operating temperature	-30°C to +80°C -22°F to +176°F
Properties	Halogen free, silicone free

### Accessories

ST Plugs 85  
KT grommets can be found from page 76 on.

Description	Type	Order No.	Clamping range on the cable shield	PU
	EMC-KTG 13	99496	13 – 14 mm	5
	EMC-KTG 14	99497	14 – 15 mm	5
	EMC-KTG 15	99498	15 – 16 mm	5
	EMC-KT 16	99475	16 – 17 mm	5
	EMC-KT 17	99476	17 – 18 mm	5
	EMC-KT 18	99477	18 – 19 mm	5
	EMC-KT 19	99478	19 – 20 mm	5
	EMC-KT 20	99479	20 – 21 mm	5
	EMC-KT 21	99480	21 – 22 mm	5
	EMC-KT 22	99481	22 – 23 mm	5
	EMC-KT 23	99482	23 – 24 mm	5
	EMC-KT 24	99483	24 – 25 mm	5
	EMC-KT 25	99484	25 – 26 mm	5
	EMC-KT 26	99485	26 – 27 mm	5
	EMC-KT 27	99486	27 – 28 mm	5
	EMC-KT 28	99487	28 – 29 mm	5
	EMC-KT 29	99488	29 – 30 mm	5
	EMC-KT 30	99489	30 – 31 mm	5
	EMC-KT 31	99490	31 – 32 mm	5
	EMC-KT 32	99491	32 – 33 mm	5
	EMC-BTG	99495	blank grommet	5

## Assembly possibilities

	Var. 1	Var. 2	Var. 3	Var. 4	Var. 5
Outside	EMC-KEL	EMC-KEL	EMC-KEL	KEL-ER (U)	EMC-KEL
Inside	–	–	KEL-EMC-PFM	EMC-KEL	–
EMC: conducted	–	✓	✓	✓	**
EMC: field-bound	✓	✓	✓	✓	–
IP rating	IP54	not defined	IP54	IP66 (IP54)	not defined
Strain relief	✓	–	✓	✓	*

\* Standard KT grommets only

\*\* EMC-KT grommets only

### Field-bound disturbances with strain relief

The EMC cable entry frame (EMC-KEL) is screwed to the outside of the housing.  
The cable shield is not exposed.

1

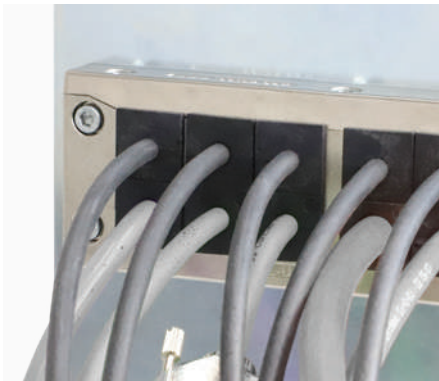

Outside



Not exposed cable shield



Profile

### Conducted and field-bound disturbances

The EMC cable entry frame (EMC-KEL) is screwed to the outside of the housing. The cable shield is exposed in the area of the cable grommets.

2



Outside



Exposed cable shield



Profile

## Conducted and field-bound disturbances with strain relief

The EMC cable entry frame (EMC-KEL) is screwed to the outside of the housing.  
 Inside the housing, the EMC bracket KEL-EMC-PFM is mounted and the exposed cable shield is placed.

3



Outside



Inside

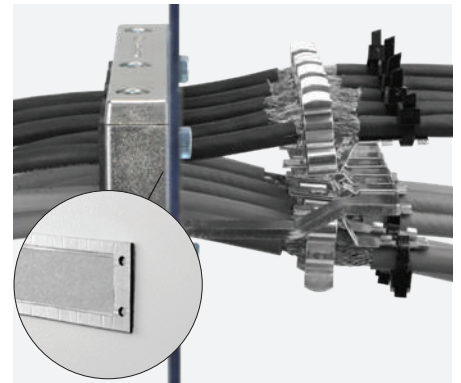

Profile

## Conducted and field-bound disturbances with strain relief and IP66

A cable entry frame (e.g., KEL-ER or KEL-U) is bolted to the outside of the housing. Inside the housing, the EMC cable entry frame (EMC-KEL) is mounted and the cable shield is exposed in the area of the cable grommets.

4



Outside



Inside



Profile

## Conducted disturbances with single strain relief

The EMC cable entry frame (EMC-KEL) is screwed to the outside of the housing.  
 The cable shield is exposed in the area of the cable grommets. It's possible to use different grommets (KT & EMC-KT).

5



Outside

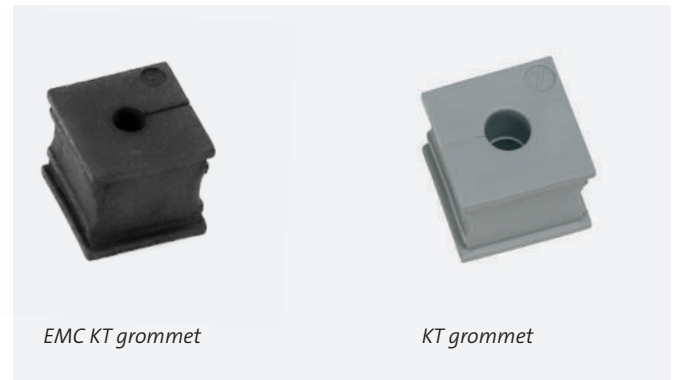

Different grommets

4  
 4.1  
 4.2  
 4.3  
 4.4

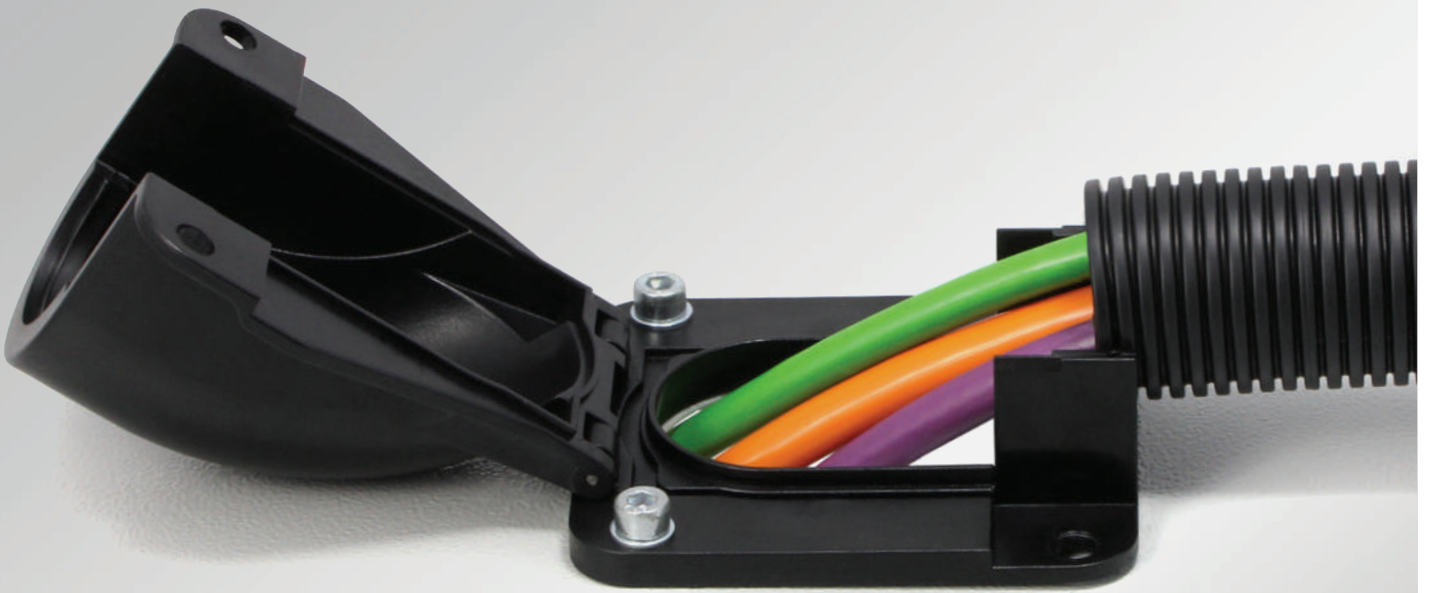

IP54    RoHS  
compliant    Made in  
Germany

CONFiX™

# Cable conduit system, cable protection conduits

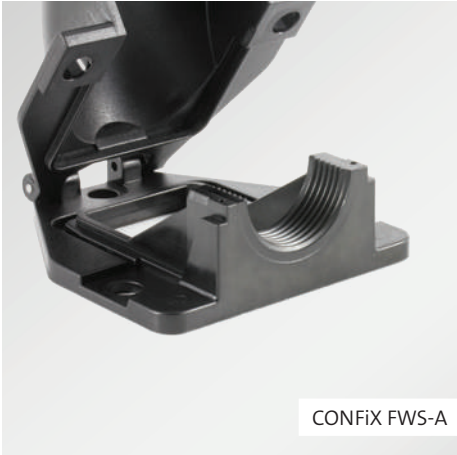

CONFiX  
Cable conduit system, cable protection conduits

5  
5.1  
5.2  
5.3

## 5 CONFiX™ Cable conduit system, cable protection conduits

IP54 RoHS compliant Made in Germany

**The 90° angled conduit fitting CONFiX FWS is perfect for installation of parallel corrugated cable protection conduits, e.g. in machines, control panels or control cabinets. The liftable cover is tightly fixed by a hinge to the mounting box. Therefore, the system is very easy to handle.**

Corrugated conduits CONFiX WS for cable routing are used where cables have to be protected from mechanical damage or certain weather conditions.

In addition, icotek offers split corrugated conduits CONFiX WST for routing pre-terminated cables and corresponding conduit clips CONFiX SH.

### Advantages & benefits

#### 1. Fast and easy assembly

The liftable cover of the bulkhead fitting CONFiX FWS is tightly fixed by a hinge to the mounting box. The system is therefore very easy to mount.

#### 2. Easy to maintain

The split version of the corrugated conduits CONFiX WST offers the possibility of routing standard or pre-terminated cables in harsh environments.

#### 3. Flexible

The corrugated conduits CONFiX WS can be used for various applications, depending on the material. Weather-resistant polyamide conduits for high mechanical requirements (indoor and outdoor use), polypropylene conduits with high resistance against acids/alkalis.



5  
5.1  
5.2  
5.3

## Conduit pass-through systems



**Bulkhead fittings, split** | IP54  
for conduit screw connections/  
direct conduit pickup

CONFiX FWS

288



**Bulkhead fittings, split** | IP54  
for conduit screw connections/  
direct conduit pickup

CONFiX FWS

289

## Cable protection conduits



**Corrugated conduits**  
NW 7.5 – NW 50

CONFiX WS

290 – 291



**Corrugated conduits, split**  
for cables with connectors  
NW 10 – NW 70

CONFiX WST

292



**Conduit clips**  
for split corrugated conduits CONFiX WST

CONFiX SH

293

## CONFiX™ FWS Assembly

Installation of CONFiX FWS  
is quick and easy:

1. Use top screw(s) to mount the FWS
2. Insert conduit
3. Secure and complete installation  
with two side screws

1



Fix

2



Insert

3

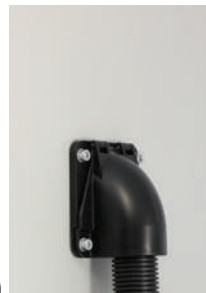

Lock

5  
5.1  
5.2  
5.3

# CONFiX™ FWS-A

## Bulkhead fittings for conduit screw connections

IP54 RoHS compliant Made in Germany



The 90° angled conduit fitting CONFiX FWS is for installation of parallel corrugated cable protection conduits, e.g. in machines, control panels or control cabinets.

The liftable cover is tightly fixed by a hinge. Therefore the system is fast and easy to install.

CONFiX FWS is offered in the following versions:

CONFiX FWS-A with metric internal thread M16 to M50

CONFiX FWS-B with a grooved conduit clip for types with sizes NW 13, 17, 23, 29, 37 and 50.

The available colours are grey (RAL 7011) and black (RAL 9005).

### Accessories

CONFiX WS conduits 290 - 291  
Punches CONFiX 388 - 389

Type	Internal Thread	Hole Ø [mm]	Size (A × B) [mm]	Cut-out (C × D) [mm]	Drill. Templ. (E × F) [mm]	Order No.	PU
CONFiX FWS-A 16	M16 × 1.5	3 × 4.3	49 × 45	22 × 22.6	29 × 37	■ 31381 ■ 31380	10
CONFiX FWS-A 20	M20 × 1.5	3 × 4.3	49 × 45	22 × 22.6	29 × 37	■ 31384 ■ 31383	10
CONFiX FWS-A 25	M25 × 1.5	3 × 6.6	67 × 63	37 × 28	41.5 × 51.5	■ 31387 ■ 31386	10
CONFiX FWS-A 32	M32 × 1.5	4 × 6.6	85.5 × 76	41.9 × 40 r = 20	64.5 × 64.5	■ 31390 ■ 31389	10
CONFiX FWS-A 40	M40 × 1.5	4 × 6.6	97 × 92	48.3 × 48.4 r = 24.2	79.5 × 79.5	■ 31393 ■ 31392	5
CONFiX FWS-A 50	M50 × 1.5	4 × 6.6	111.5 × 100.5	53 × 60.5 r = 30.25	87.5 × 87.5	■ 31396 ■ 31395	5

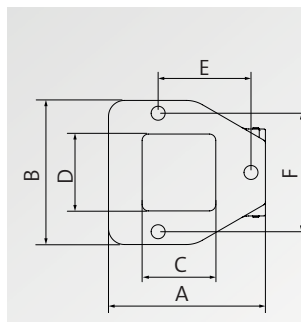

Size/Drilling template  
FWS-A 16 to 25

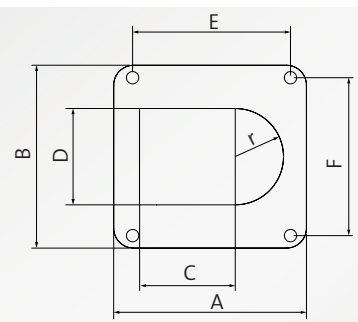

Size/Drilling template  
FWS-A 32 to 50

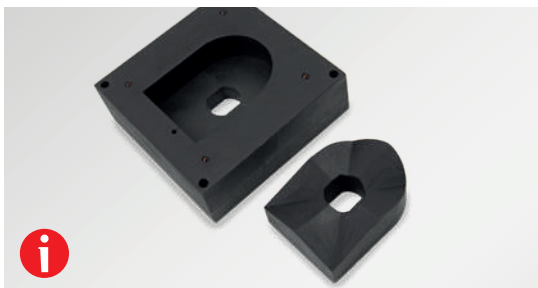

Matching sheet metal punches on p. 322



Metric internal thread for conduit screw connections



# CONFIX™ FWS-B

Bulkhead fittings  
for direct conduit pickup

IP54 RoHS compliant Made in Germany



## Advantages & benefits

- Hinged cover
- Fast and easy installation
- Functional design
- Protection class IP54

## Specifications

Material	Polycarbonate (PC)
Colour	■ grey (RAL 7011) ■ black (RAL 9005)
IP rating	IP54
Flame class	UL94-V0, self-extinguishing
Temperature	-30°C to +100°C (static)
Properties	Halogen free, silicone free

## Accessories

CONFIX WS conduits	290 - 291
Punches CONFIX	388 - 389

Type	Dimension*	Hole Ø [mm]	Size (A × B) [mm]	Cut-out (C × D) [mm]	Drill. Templ. (E × F) [mm]	Order No.	PU
CONFIX FWS-B 11	NW 13	3 × 4.3	49 × 45	22 × 22.6	29 × 37	■ 31411 ■ 31410	10
CONFIX FWS-B 16	NW 17	3 × 4.3	49 × 45	22 × 22.6	29 × 37	■ 31414 ■ 31413	10
CONFIX FWS-B 21	NW 23	3 × 6.6	67 × 63	37 × 28	41.5 × 51.5	■ 31417 ■ 31416	10
CONFIX FWS-B 29	NW 29	4 × 6.6	85.5 × 76	41.9 × 40 r = 20	64.5 × 64.5	■ 31420 ■ 31419	10
CONFIX FWS-B 36	NW 37	4 × 6.6	97 × 92	48.3 × 48.4 r = 24.2	79.5 × 79.5	■ 31423 ■ 31422	5
CONFIX FWS-B 48	NW 50	4 × 6.6	111.5 × 100.5	53 × 60.5 r = 30.25	87.5 × 87.5	■ 31426 ■ 31425	5

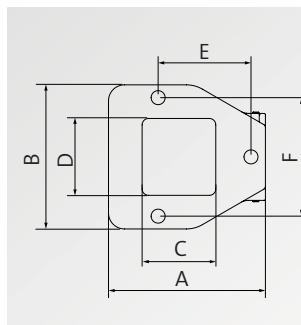

Size/Drilling template  
FWS-B 11 to 21

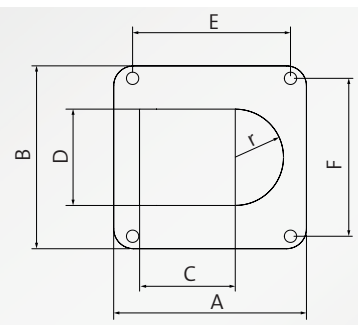

Size/Drilling template  
FWS-B 29 to 48

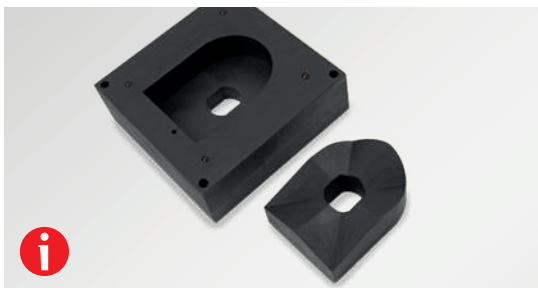

Matching sheet metal punches on p. 322



Grooved conduit clip



Fixed cover due to hinges

5  
5.1  
5.2  
5.3

\* For parallel corrugated cable protection conduit with dimension (NW)



Parallel corrugated conduits for cable routing are used where cables have to be protected from mechanical damage or certain weather conditions.

icotek provides conduits in sizes NW 7.5, 8.5, 10, 13, 17, 23, 29, 37, and 50.

Conduits from size NW 13 can be mounted with CONFiX FWS bulkhead fittings.

Parallel corrugated conduits are available in 3 different versions:

- CONFiX WS-PA: Polyamide conduit for high mechanical requirements (e.g. engine compartments, car bodies, construction machines, ship building, rail transportation technology, switch cabinets).

→ Suitable for ground installation

- CONFiX WS-PAL (light): Polyamide conduit for high mechanical requirements

→ Suitable for suspended installation

- CONFiX WS-PP: Polypropylene conduit for use in engine compartments, car bodies and for static installation at machinery and plant engineering.

→ Advantages: Cost-effective, flame class UL94-V2, temperature resistant, resistant to chemicals, UV resistant

Type	External Ø	Internal Ø	Compatible with	Order No.	PU (Length)
CONFiX WS-G-PA-NW 7.5	Ø 10 mm	Ø 6.7 mm	–	■ 31550	50 m
CONFiX WS-B-PA-NW 7.5	Ø 10 mm	Ø 6.7 mm	–	■ 31570	50 m
CONFiX WS-G-PA-NW 8.5	Ø 11.4 mm	Ø 8.4 mm	–	■ 31552	50 m
CONFiX WS-B-PA-NW 8.5	Ø 11.4 mm	Ø 8.4 mm	–	■ 31572	50 m
CONFiX WS-G-PA-NW 10	Ø 13 mm	Ø 9.9 mm	–	■ 31554	50 m
CONFiX WS-B-PA-NW 10	Ø 13 mm	Ø 9.9 mm	–	■ 31574	50 m
CONFiX WS-G-PA-NW 13	Ø 15.8 mm	Ø 12.7 mm	CONFiX FWS-B 11	■ 31556	50 m
CONFiX WS-B-PA-NW 13	Ø 15.8 mm	Ø 12.7 mm	CONFiX FWS-B 11	■ 31576	50 m
CONFiX WS-G-PA-NW 17	Ø 21.2 mm	Ø 16.6 mm	CONFiX FWS-B 16	■ 31558	50 m
CONFiX WS-B-PA-NW 17	Ø 21.2 mm	Ø 16.6 mm	CONFiX FWS-B 16	■ 31578	50 m
CONFiX WS-G-PA-NW 23	Ø 28.3 mm	Ø 23.2 mm	CONFiX FWS-B 21	■ 31560	50 m
CONFiX WS-B-PA-NW 23	Ø 28.3 mm	Ø 23.2 mm	CONFiX FWS-B 21	■ 31580	50 m
CONFiX WS-G-PA-NW 29	Ø 34.5 mm	Ø 29 mm	CONFiX FWS-B 29	■ 31562	25 m
CONFiX WS-B-PA-NW 29	Ø 34.5 mm	Ø 29 mm	CONFiX FWS-B 29	■ 31582	25 m
CONFiX WS-G-PA-NW 37	Ø 42.4 mm	Ø 36 mm	CONFiX FWS-B 36	■ 31564	25 m
CONFiX WS-B-PA-NW 37	Ø 42.4 mm	Ø 36 mm	CONFiX FWS-B 36	■ 31584	25 m
CONFiX WS-G-PA-NW 50	Ø 54.5 mm	Ø 47.7 mm	CONFiX FWS-B 48	■ 31566	25 m
CONFiX WS-B-PA-NW 50	Ø 54.5 mm	Ø 47.7 mm	CONFiX FWS-B 48	■ 31586	25 m



Compatible with CONFiX FWS-B

# CONFIX™ WS

## Corrugated conduits



### Specifications WS-PA

Material	Polyamide (PA)
Colour	■ black ■ grey
Flame class	UL 94-HB
Temperature	-40°C to +120°C
Properties	Halogen free, weather-resistant

### Specifications WS-PAL

Material	Polyamide (PA)
Colour	■ black
Flame class	UL 94-HB
Temperature	-40°C to +120°C
Properties	Halogen free, weather-resistant

### Specifications WS-PP

Material	Polypropylene (PP)
Colour	■ black
Flame class	UL 94 V-2, self-extinguishing
Temperature	-40°C to +135°C
Properties	Halogen free UV resistant High resistance against acids/alkalis

### Compatible with

CONFIX FWS Bulkhead fitting	288 - 289
-----------------------------	-----------

Type	External Ø	Internal Ø	Compatible with	Order No.	PU (Length)
CONFIX WS-B-PAL-NW 7.5	Ø 10 mm	Ø 6.7 mm	–	■ 31590	50 m
CONFIX WS-B-PAL-NW 8.5	Ø 11.4 mm	Ø 8.4 mm	–	■ 31592	50 m
CONFIX WS-B-PAL-NW 10	Ø 13 mm	Ø 9.9 mm	–	■ 31594	50 m
CONFIX WS-B-PAL-NW 13	Ø 15.8 mm	Ø 12.7 mm	CONFIX FWS-B 11	■ 31596	50 m
CONFIX WS-B-PAL-NW 17	Ø 21.2 mm	Ø 16.6 mm	CONFIX FWS-B 16	■ 31598	50 m
CONFIX WS-B-PAL-NW 23	Ø 28.3 mm	Ø 23.2 mm	CONFIX FWS-B 21	■ 31600	50 m
CONFIX WS-B-PAL-NW 29	Ø 34.5 mm	Ø 29 mm	CONFIX FWS-B 29	■ 31602	25 m
CONFIX WS-B-PAL-NW 37	Ø 42.4 mm	Ø 36 mm	CONFIX FWS-B 36	■ 31604	25 m
CONFIX WS-B-PAL-NW 50	Ø 54.4 mm	Ø 47.7 mm	CONFIX FWS-B 48	■ 31606	25 m
CONFIX WS-B-PP-NW 7.5	Ø 10 mm	Ø 7.1 mm	–	■ 31610	50 m
CONFIX WS-B-PP-NW 8.5	Ø 11.4 mm	Ø 8.4 mm	–	■ 31612	50 m
CONFIX WS-B-PP-NW 10	Ø 13 mm	Ø 9.9 mm	–	■ 31614	50 m
CONFIX WS-B-PP-NW 13	Ø 15.8 mm	Ø 12.7 mm	CONFIX FWS-B 11	■ 31616	50 m
CONFIX WS-B-PP-NW 17	Ø 21.2 mm	Ø 16.6 mm	CONFIX FWS-B 16	■ 31618	50 m
CONFIX WS-B-PP-NW 23	Ø 28.3 mm	Ø 23.2 mm	CONFIX FWS-B 21	■ 31620	50 m
CONFIX WS-B-PP-NW 29	Ø 34.5 mm	Ø 29 mm	CONFIX FWS-B 29	■ 31622	25 m
CONFIX WS-B-PP-NW 37	Ø 42.4 mm	Ø 36 mm	CONFIX FWS-B 36	■ 31624	25 m
CONFIX WS-B-PP-NW 50	Ø 54.5 mm	Ø 47.7 mm	CONFIX FWS-B 48	■ 31626	25 m

# CONFIX™ WST

## Split corrugated conduits



The CONFIX WST is a two-part corrugated conduit that is perfect for routing cables with or without connectors in harsh environments.

In conjunction with e.g. KVT-W90, a high degree of flexibility is achieved. Numerous conduit sizes can be used thanks to the wide variety of split grommets offered.

**The length of the CONFIX WST split corrugated conduit can be customized to your application. All conduits are available by the meter (0.5 m steps).**

### Advantages & benefits

- Containing pre-terminated cables, warranty of cable remains
- Retrofitting and maintenance carried out easily and quickly

### Specifications

Material	Polypropylene, black
Flame class	UL 94-V2
Temperature	- 30°C to + 105°C
Properties	UV resistant

### Compatible with

CONFIX SH Conduit clip	293
Cable entry systems for pre-terminated cable	10 - 137
Cable entry systems for standard cables	138 - 185

Type	Order No.	Internal Ø	External Ø	Compatible with	Compatible with CONFIX FWS-B	Dimensions	Ring length*	Bending radius (static)
CONFIX WST NW 10	31200	8.4 mm	13.4 mm	KT 13	–	NW 10	50 m*	25 mm
CONFIX WST NW 14	31210	12.5 mm	18.5 mm	KT 18	31411 31410	NW 14	50 m*	35 mm
CONFIX WST NW 16	31215	16 mm	21.5 mm	KT 22	31414 31413	NW 16	50 m*	40 mm
CONFIX WST NW 20	31220	19.2 mm	25.30 mm	KT 25	–	NW 20	50 m*	45 mm
CONFIX WST NW 23	31230	23.4 mm	30.8 mm	KT 30	31417 31416	NW 23	50 m*	50 mm
CONFIX WST NW 29	31235	27.3 mm	35.5 mm	KTMB-P	31420 31419	NW 29	25 m*	90 mm
CONFIX WST NW 37	31240	31 mm	41.4 mm	KTMB-P	31423 31422	NW 37	25 m*	110 mm
CONFIX WST NW 45	31250	42.7 mm	54 mm	KTMB-Q	31426 31425	NW 45	25 m*	130 mm
CONFIX WST NW 70	31260	67 mm	79.8 mm	KEL-ULTRA flex	–	NW 70	10 m*	190 mm



*Individual lengths are possible!*

# CONFIX™ SH

## Conduit clips for WST



CONFIX SH Conduit clips are a one-piece clamping system to provide secure mounting points for corrugated conduit systems.

The clips are secured to their mounting position through a central mounting point with a hexagonal counter-bore.

### Specifications

Material	Polyamide (PA), black
Flame class	UL94-V2, self-extinguishing
Temperature	- 40°C to + 120°C
Properties	Halogen free, silicone free

### Compatible with

CONFIX WST	
Split corrugated conduit	292

Type	Order No.	Suitable conduit	Fixing hole	Width [mm]	Height [mm]	PU
CONFIX SH 10	31300	WST NW 10	M5	18.5	21	10
CONFIX SH 14	31310	WST NW 14	M5	24	25.5	10
CONFIX SH 16	31315	WST NW 16	M6	30	35	10
CONFIX SH 20	31320	WST NW 20	M6	35	36	10
CONFIX SH 23	31330	WST NW 23	M6	42	43.5	10
CONFIX SH 29	31335	WST NW 29	M6	48	48.5	10
CONFIX SH 37	31340	WST NW 37	M6	55	56.5	10
CONFIX SH 45	31350	WST NW 45	M6	67	68	10
CONFIX SH 70	31360	WST NW 70	M6	100	101	10





							
---	---	---	---	---	---	---	--

# Enclosure accessories

## Gland plates, flange plates and accessories

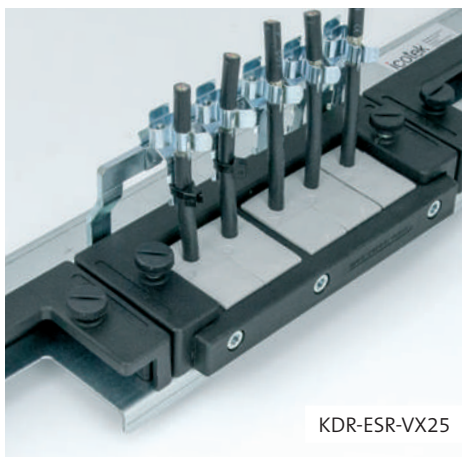

KDR-ESR-VX25



MP

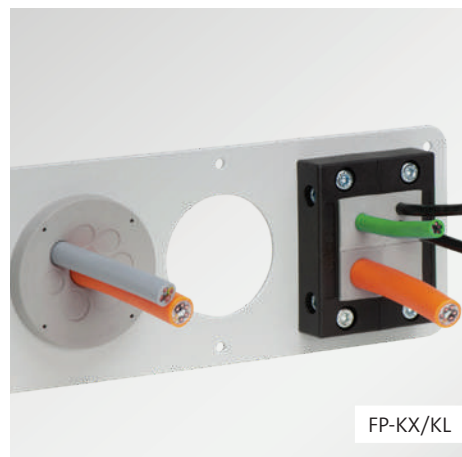

FP-KX/KL

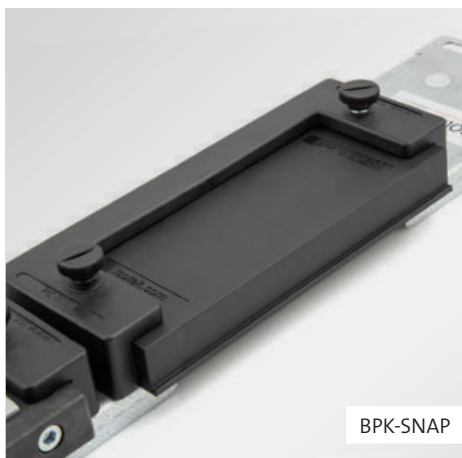

BPK-SNAP



TE-M



KEA



GMT



PCE

Enclosure accessories

6
6.1
6.2
6.3
6.4
6.5
6.6

## 6 Enclosure accessories

### Gland plates, flange plates and accessories

**Ready-to-install enclosure gland plates, onto which the pre-assembled cable entry frames can be directly screwed, ensure quick and easy cable entry into the enclosure base.**



Cables are automatically relieved of tension and held securely in the enclosure thanks to the 'integrated' strain relief of the cable entries. The fact that the systems are fully separable is particularly advantageous for maintenance or retrofitting, as there is no need to disconnect the cables.

Complete flange plates for Rittal AX enclosures, AE enclosures, KX/KL terminal boxes or BG bus enclosures, as well as prepared module plates with standard cut-outs for mounting icotek cable entry systems in the enclosure base, are also available in many variants.

icotek offers a wide range of useful accessories for enclosures for the installation of cable entry systems and cable glands as well as for cable management.

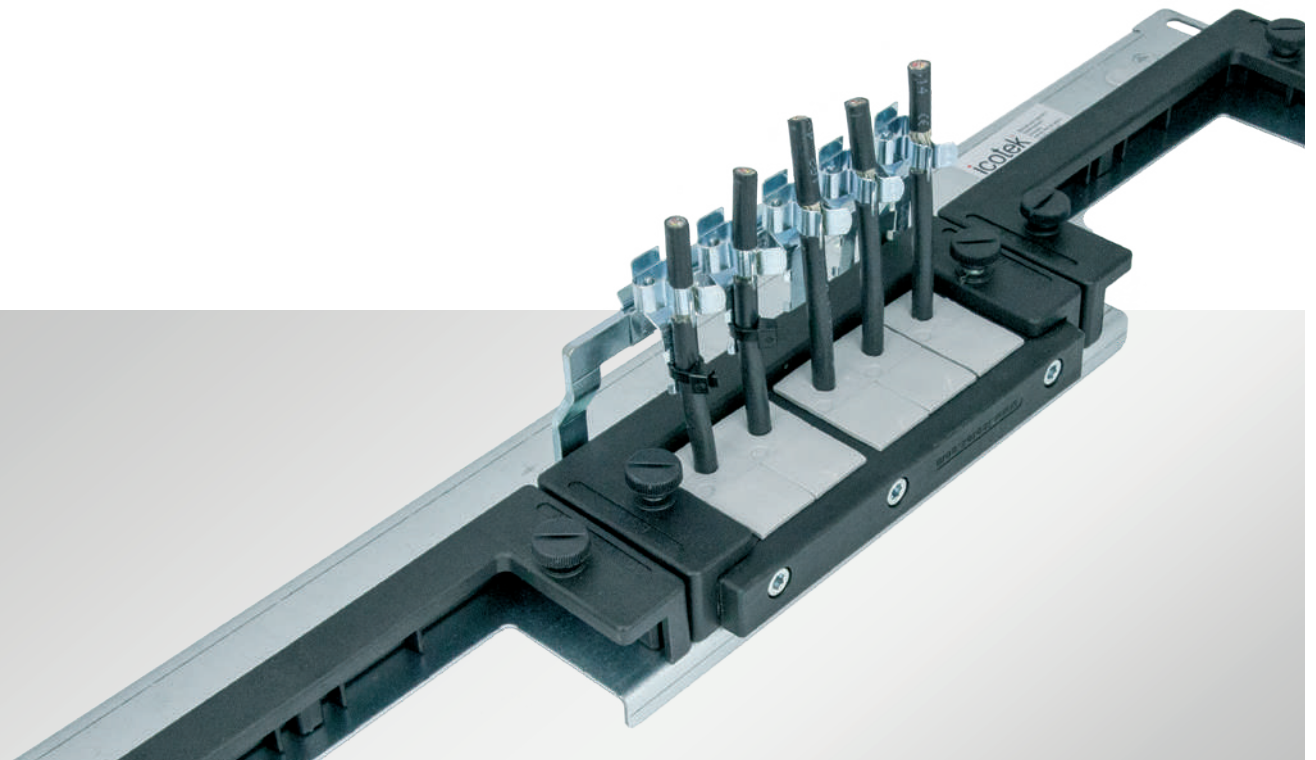

6  
6.1  
6.2  
6.3  
6.4  
6.5  
6.6



## The patented KDR base entry systems

**KDR-ESR-VX25**



**KDRS-ESR-VX25**



Routing of pre-terminated cables of up to 65 mm in diameter (KEL-JUMBO)



Optional with EMC cable assembly KDR-EMC-PFM



Fast and tool-free mounting of KEL-U cable entry frames



Routing of pre-terminated cables of up to 35 mm in diameter (KEL-U 24)



Straight cable routing into the cable duct

## 6 Enclosure accessories

### Gland plates, flange plates and accessories



### Gland plates and module plates for enclosures

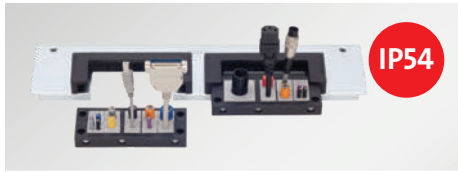

Rittal/Hoffman/Häwa  
Enclosure gland plates  
with slide frames for cable entry frames

KDR-ESR-VX25 / KDRS-ESR-VX25 /  
KDR-ESR-TS8 / KDR-ESR-HW / KDR-ESR-HG2  
**300 – 311**



Rittal  
Enclosure gland plates  
for cable entry frames

KDR-VX25  
**304 – 305**



Rittal  
Enclosure gland plates  
split, for cable entry frames

KDR 2-VX25 / KDR 2-TS8  
**312 – 313**



Rittal/Lohmeier  
Module plates  
for cable entry components

MP  
**314 – 315**

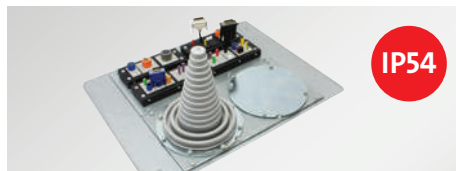

Rittal  
Enclosure gland plates  
for MP module plates

KDR-BMP-VX25 / KDR-BMP-TS8  
**316 – 319**

### Flange plates for enclosures, blank plates



Rittal  
Flange plates for enclosures  
for cable entry components

FP-AX / FP-AE / FP-KX / FP-KL  
**320 – 327**



Fibox  
Flange plates for enclosures  
for cable entry components

FP-BG / FP-FL21  
**328 – 329**



Blank plates  
BPK / BPK-RF / BPM / BPK-SNAP

**330 – 332**

### Thread extension and accessories



Thread extension  
for cable glands and cable entry plates  
M32, M50, M63

TE-M  
**334 – 337**



Accessories for TE-M  
Adapter, cover panel

TE-MA, AB-M  
**338 – 339**

6  
6.1  
6.2  
6.3  
6.4  
6.5  
6.6

## KEA 90° Cable entry adapter



90° Cable entry adapter  
for cable entry frames and cable entry plates

KEA

340 – 343

## Further accessories for enclosures



Hexagonal Locknuts  
M16 – M85

KGM / GM / GMT

346



Supports  
for top hat DIN rails and bus bars

MF

347

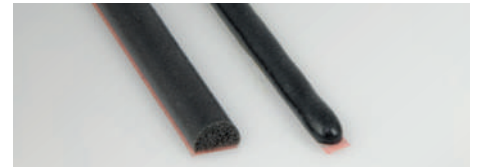

Sealing bead  
for enclosure base plates

348



Drainage Device

349



Pressure compensation element  
with metric thread

PCE M12 x 1,5

349

6  
6.1  
6.2  
6.3  
6.4  
6.5  
6.6

# KDR-ESR-VX25

## Rittal enclosure gland plate with slide frames

The KDR-ESR is a one-piece plate to be assembled on enclosure bases. Slide frames for the KEL cable entry frames are already pre-assembled.

After installing all cables into the KEL frames, they are easily and quickly inserted into the slide frames and fixed. During maintenance, the KEL frames are removed without tools from the slide frames. Due to the combination KDR-ESR and KEL cable entry frames, a rating of IP54 is achieved (with correct selection of cable grommets). Slide frames which are no longer required are closed with BPK-SNAP blank plates.

### Advantages & benefits

- Easy assembly and removal
- Prepared for the assembly of KDR-EMV-PFM
- Ideal for maintenance and retrofitting
- Reserve can be scheduled
- Space-saving solution
- No additional sheet metal work required

### Specifications

Material	Gland plate: Sheet steel, zinc-plated KDR-ESR Frame: Polyamide (PA)
Flame class	UL 94 V-0, self-extinguishing
IP rating	IP54, with gasket and correct selection of cable entry devices
Temperature	- 40°C to + 90°C (static)
Properties	Halogen free, silicone free

### Compatible with

KEL(-U) 16 / 24 Cable entry frames	21
KEL-ER 16 / 24 Cable entry frames	17
KEL-JUMBO Cable entry frames	56 - 57
BPK-SNAP 16 / 24 Blank plates	330

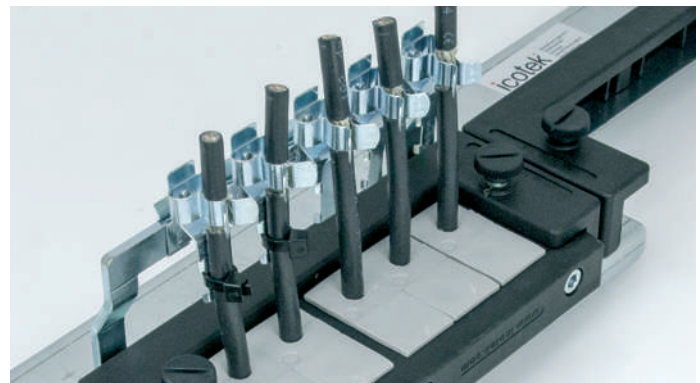

Slide frames which are no longer required are closed with BPK-SNAP blank plates

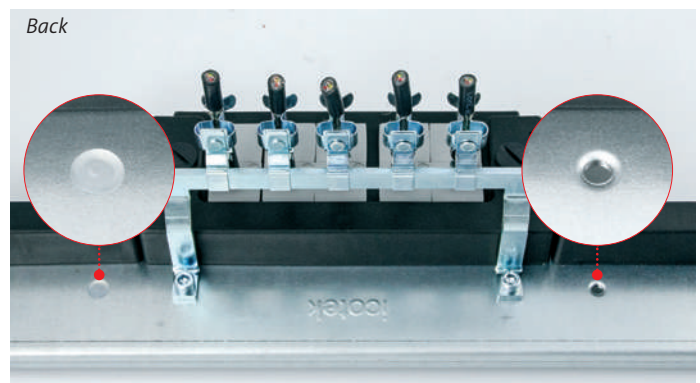

Back  
Prepared for the assembly of KDR-EMV-PFM. The plates are fitted with threaded screw holes (M5), blocked with plugs. These can be easily removed if necessary. By using the KDR-EMV-PFM, there is no need to additionally install a DIN rail/bus bar above the cable entry, which would otherwise have to be attached in order to implement the EMC connection.

# KDR-ESR-VX25

## Rittal enclosure gland plate with slide frames

Type	Enclosure width	Total length gland plate	Sight size of base plate opening	No. of possible cable entries				Order No.
				JUMBO 1	JUMBO 2	KEL(-U) 16 ...	KEL(-U) 24 ...	
KDR-ESR-VX25-600	600 mm	488 mm	452 mm	-	-	-	2	44500
KDR-ESR-VX25-600	600 mm	488 mm	452 mm	-	1	-	1	44501
KDR-ESR-VX25-600	600 mm	488 mm	452 mm	1	-	2	-	44502
KDR-ESR-VX25-800	800 mm	688 mm	652 mm	-	-	1	3	44503
KDR-ESR-VX25-800	800 mm	688 mm	652 mm	1	-	1	2	44504
KDR-ESR-VX25-800	800 mm	688 mm	652 mm	-	1	-	2	44505
KDR-ESR-VX25-1000	1000 mm* with division bar	438 mm	402 mm	-	-	-	2	44506
KDR-ESR-VX25-1000	1000 mm* with division bar	438 mm	402 mm	1	-	-	1	44507
KDR-ESR-VX25-1000	1000 mm* with division bar	438 mm	402 mm	-	1	1	-	44508
KDR-ESR-VX25-1200	1200 mm*	538 mm	502 mm	-	-	-	3	44509
KDR-ESR-VX25-1200	1200 mm*	538 mm	502 mm	1	-	1	1	44510
KDR-ESR-VX25-1200	1200 mm*	538 mm	502 mm	-	1	-	1	44511

\* if both fields of the enclosure are fitted, two complete gland plates are required.

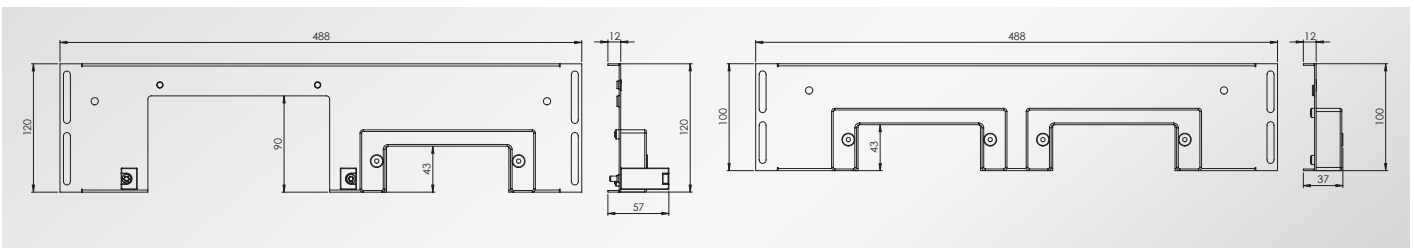

### EMC cable assembly for KDR-ESR-VX25

Type	Order No.	Material	PU
KDR-EMC-PFM 16	39192	Steel, zinc plated	1
KDR-EMC-PFM 24	39191	Steel, zinc plated	1



Suitable EMC shield clamps can be found on pages 238, 239 (PFSZ, SKS, SS|SK, SS|SKZ).

# KDRS-ESR-VX25

## Rittal enclosure gland plate, narrow, with slide frames



The KDRS-ESR is a one-piece plate to be assembled on enclosure bases. Slide frames for the KEL cable entry frames are already pre-assembled.

After installing all cables into the KEL frames, they are easily and quickly inserted into the slide frames and fixed. During maintenance, the KEL frames are removed without tools from the slide frames. Due to the combination KDRS-ESR and KEL cable entry frames, a rating of IP54 is achieved (with correct selection of cable grommets). Slide frames which are no longer required, are closed with BPK-SNAP blank plates.

### Advantages & benefits

- Easy assembly and removal
- The KDRS-ESR floor plate is very narrow. As a result, the inserted cables are inserted straight into the cable duct.
- Ideal for maintenance and retrofitting
- Reserve can be scheduled
- Space-saving solution
- No additional sheet metal work required

### Specifications

Material	Gland plate: Sheet steel, zinc-plated KDR-ESR Frame: Polyamide (PA)
Flame class	UL 94 V-0, self-extinguishing
IP rating	IP54, with gasket and correct selection of cable entry devices
Temperature	-40°C to +90°C (static)
Properties	Halogen free, silicone free

### Compatible with

KEL(-U) 16 / 24 Cable entry frames	21
KEL-ER 16 / 24 Cable entry frames	17
BPK-SNAP 16 / 24 Blank plates	330



*Advantage KDRS: Straight cable routing into the cable duct due to the extremely narrow gland plate*

# KDRS-ESR-VX25

Rittal enclosure gland plate,  
**narrow**, with slide frames



Type	Enclosure width	Total length gland plate	Sight size of base plate opening	No. of possible cable entries				Order No.
				JUMBO 1	JUMBO 2	KEL(-U) 16 ...	KEL(-U) 24 ...	
KDRS-ESR-VX25-600 (narrow) 75 mm	600 mm	488 mm	452 mm	–	–	–	2	44512
KDRS-ESR-VX25-800 (narrow) 75 mm	800 mm	688 mm	652 mm	–	–	–	3	44513
KDRS-ESR-VX25-1000 (narrow) 75 mm	1000 mm*	438 mm	402 mm	–	–	–	2	44514
KDRS-ESR-VX25-1200 (narrow) 75 mm	1200 mm*	538 mm	502 mm	–	–	–	3	44515

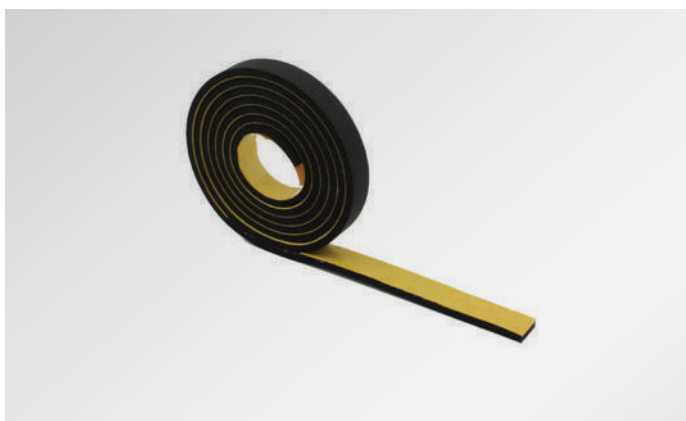
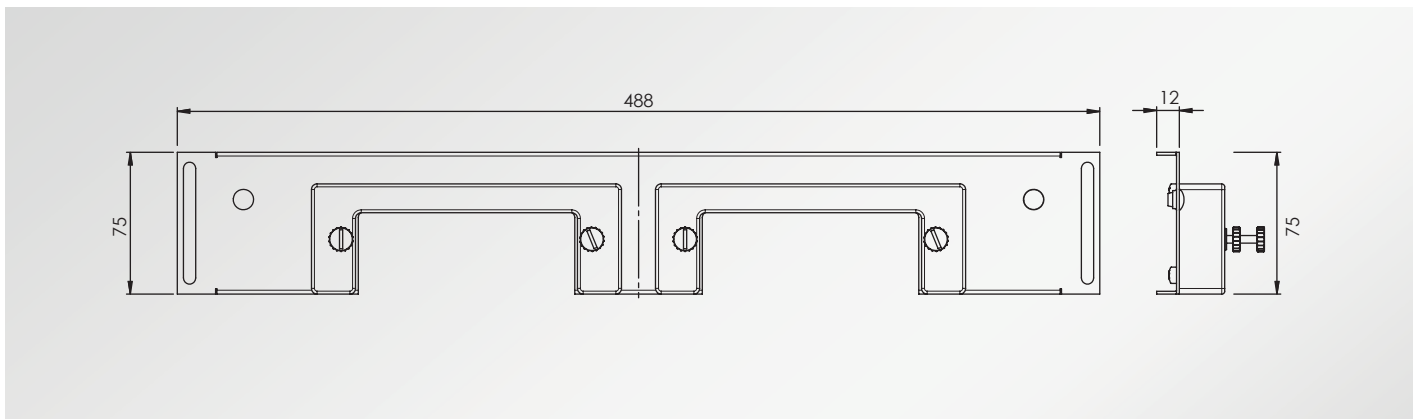

Sealing tape  
**Order No. 42999 (L: 1 m)**  
**Order No. 42999.10000 (L: 10 m)**

**i** icotek can also produce enclosure gland plates for numerous other enclosure brands and in other sizes according to your wishes. Ask us at [pm@icotek.com](mailto:pm@icotek.com)!

\* if both fields of the enclosure are fitted, two complete gland plates are required.

# KDR-VX25

## Rittal VX25 enclosure gland plate



KDR-VX25 is a one-piece gland plate to be assembled on enclosure bases. The gland plates are already equipped with cut-outs for the KEL 24 or KEL-JUMBO cable entry systems or the KEL-DPR cable entry plate.

The fastening threads for the KEL frames are already integrated.

### Advantages

- Easy assembly of the KEL(-U) 24, KEL-ER 24, KEL-FA 24, KEL-QUICK, KEL-DPR bzw. KEL-JUMBO
- Prepared for the assembly of KDR-EMV-PFM
- Threaded pull-through for earthing tape integrated
- Ideal for maintenance and retrofitting
- Reserve can be scheduled
- Space-saving solution
- No additional sheet metal work required
- Very large connectors can be inserted with ease
- Cut-outs which are no longer required are closed with BPM or BPK blank plates
- The KDR-VX25 gland plate is designed for Rittal VX25 enclosures. Other sizes are also available on request.

### Specifications

Material Sheet steel, zinc-plated

### Compatible with

KEL(-U) 24 Cable entry frames	21
KEL-ER 24 Cable entry frames	17
KEL-FA 24 Cable entry frames	25
KEL-QUICK Cable entry frames	104 - 107
KEL-JUMBO Cable entry frames	57
KEL-DPR Cable entry plates	160 - 161
BPM, BPK Blank plates	330 - 331

### Accessories

KDR-EMV-PFM 24	301
KEL-EMV-PFM 24	261

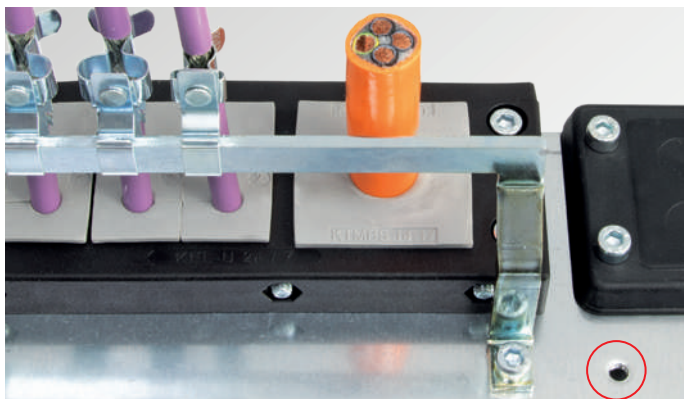
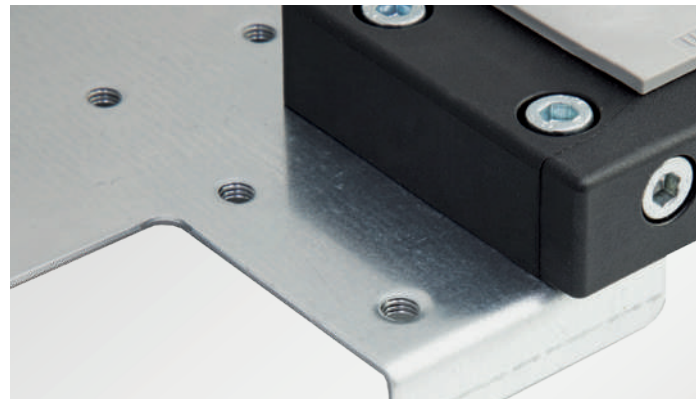
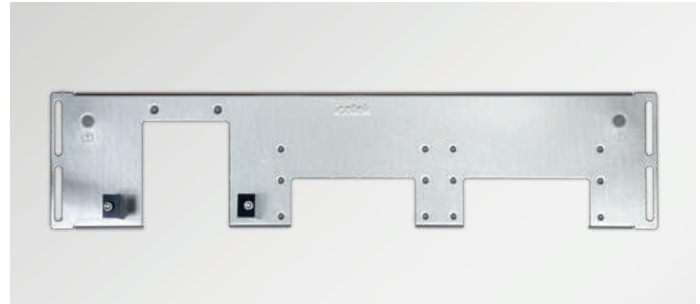

Prepared for the assembly of KDR-EMV-PFM. The plates are fitted with threaded screw holes (M5), blocked with plugs.



The fastening threads for the KEL frames are already integrated



# KDR-VX25

## Rittal VX25 enclosure gland plate

Type	Enclosure width	Total length gland plate	Sight size of base plate opening	No. of possible cable entries			Order No.
				JUMBO 1	JUMBO 2	KEL(-U) 24 ...	
KDR-VX25-600	600 mm	488 mm	452 mm	–	–	2	44300
KDR-VX25-600	600 mm	488 mm	452 mm	–	1	1	44301
KDR-VX25-600	600 mm	488 mm	452 mm	1	–	2	44302
KDR-VX25-800	800 mm	688 mm	652 mm	–	–	4	44303
KDR-VX25-800	800 mm	688 mm	652 mm	1	–	3	44304
KDR-VX25-800	800 mm	688 mm	652 mm	–	1	2	44305
KDR-VX25-1000	1000 mm	438 mm	402 mm	–	–	2	44306
KDR-VX25-1000	1000 mm	438 mm	402 mm	1	–	1	44307
KDR-VX25-1000	1000 mm	438 mm	402 mm	–	1	1	44308
KDR-VX25-1200	1200 mm	538 mm	502 mm	–	–	3	44309
KDR-VX25-1200	1200 mm	538 mm	502 mm	1	–	2	44310
KDR-VX25-1200	1200 mm	538 mm	502 mm	–	1	1	44311

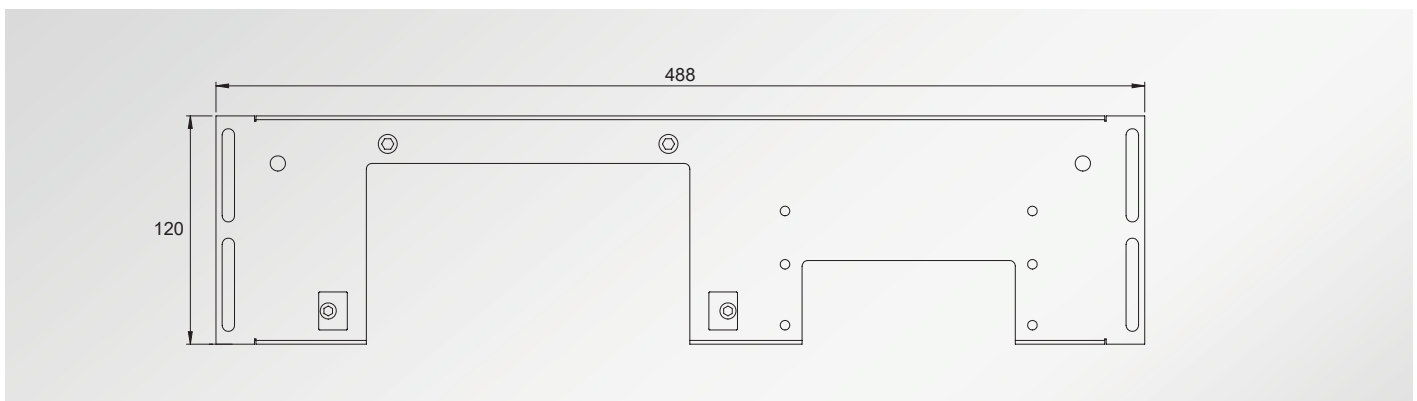

6  
6.1  
6.2  
6.3  
6.4  
6.5  
6.6

# KDR-ESR-TS8

## Rittal TS8 enclosure gland plate with slide frames



The KDR-ESR is a one-piece plate to be assembled on enclosure bases. Slide frames for the KEL cable entry frames are already pre-assembled.

After installing all cables into the KEL frames, they are easily and quickly inserted into the slide frames and fixed. During maintenance, the KEL frames are removed without tools from the slide frames. Due to the combination KDR-ESR and KEL cable entry frames, a rating of IP54 is achieved (with correct selection of cable grommets). Slide frames which are no longer required are closed with BPK-SNAP blank plates.

### Advantages & benefits

- Easy assembly and removal
- During assembly, almost the complete base of the enclosure can be used for installation of cables
- Even large connectors can be installed easily
- The gland plate KDR-ESR is designed for Rittal enclosures VX25 & TS 8. Other sizes can be supplied on request
- No additional sheet metal work required
- Retrofitting possible without disconnecting cables. Everything can be built around the cables

### Specifications

Material	Gland plate: Sheet steel, zinc-plated KDR-ESR Frame: Polyamide (PA)
Flame class	UL 94 V-0, self-extinguishing
IP rating	IP54, with gasket and correct selection of cable entry devices
Temperature	- 40°C to + 90°C (static)
Properties	Halogen free, silicone free

### Compatible with

KEL(-U) 16 / 24 Cable entry frames	21
KEL-ER 16 / 24 Cable entry frames	17
KEL-JUMBO Cable entry frames	56 - 57
BPK-SNAP 16 / 24 Blank plates	332

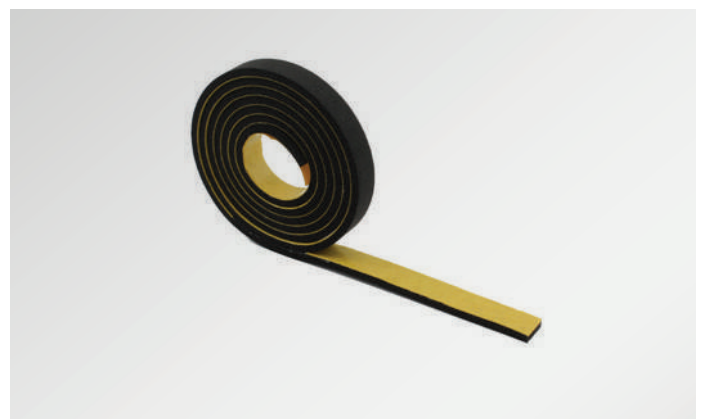
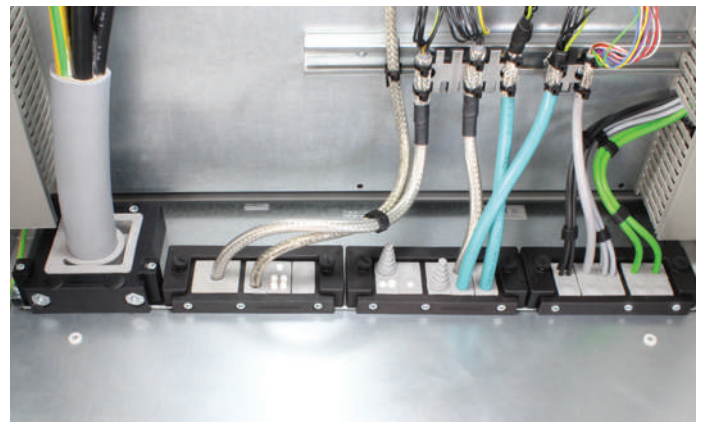

Sealing tape  
Order No. 42999 (L: 1 m)  
Order No. 42999.10000 (L: 10 m)

# KDR-ESR-TS8

## Rittal TS8 enclosure gland plate with slide frames

Type	Enclosure width	Total length gland plate	Sight size of base plate opening	No. of possible cable entries				Order No.
				JUMBO 1	JUMBO 2	KEL(-U) 16 ...	KEL(-U) 24 ...	
KDR-ESR-TS8-600	600 mm	458 mm	435 mm	-	-	-	2	43079
KDR-ESR-TS8-600	600 mm	458 mm	435 mm	-	1	-	1	43070
KDR-ESR-TS8-600	600 mm	458 mm	435 mm	1	-	2	-	43071
KDR-ESR-TS8-800	800 mm	658 mm	635 mm	-	-	1	3	43080
KDR-ESR-TS8-800	800 mm	658 mm	635 mm	1	-	-	3	43072
KDR-ESR-TS8-800	800 mm	658 mm	635 mm	-	1	-	2	43073
KDR-ESR-TS8-1000	1000 mm without division bar	858 mm	835 mm	-	-	-	5	43081
KDR-ESR-TS8-1000	1000 mm without division bar	858 mm	835 mm	1	-	-	4	43074
KDR-ESR-TS8-1000	1000 mm without division bar	858 mm	835 mm	-	1	-	3	43075
KDR-ESR-TS8-1000	1000 mm* with division bar	420 mm	398 mm	-	-	-	2	43082
KDR-ESR-TS8-1000	1000 mm* with division bar	420 mm	398 mm	1	-	-	1	43076
KDR-ESR-TS8-1000	1000 mm* with division bar	420 mm	398 mm	-	1	-	1	43077
KDR-ESR-TS8-1200	1200 mm*	518 mm	495 mm	-	-	-	3	43083
KDR-ESR-TS8-1200	1200 mm*	518 mm	495 mm	1	-	-	2	43078
KDR-ESR-TS8-1200	1200 mm*	518 mm	495 mm	-	1	-	1	43084

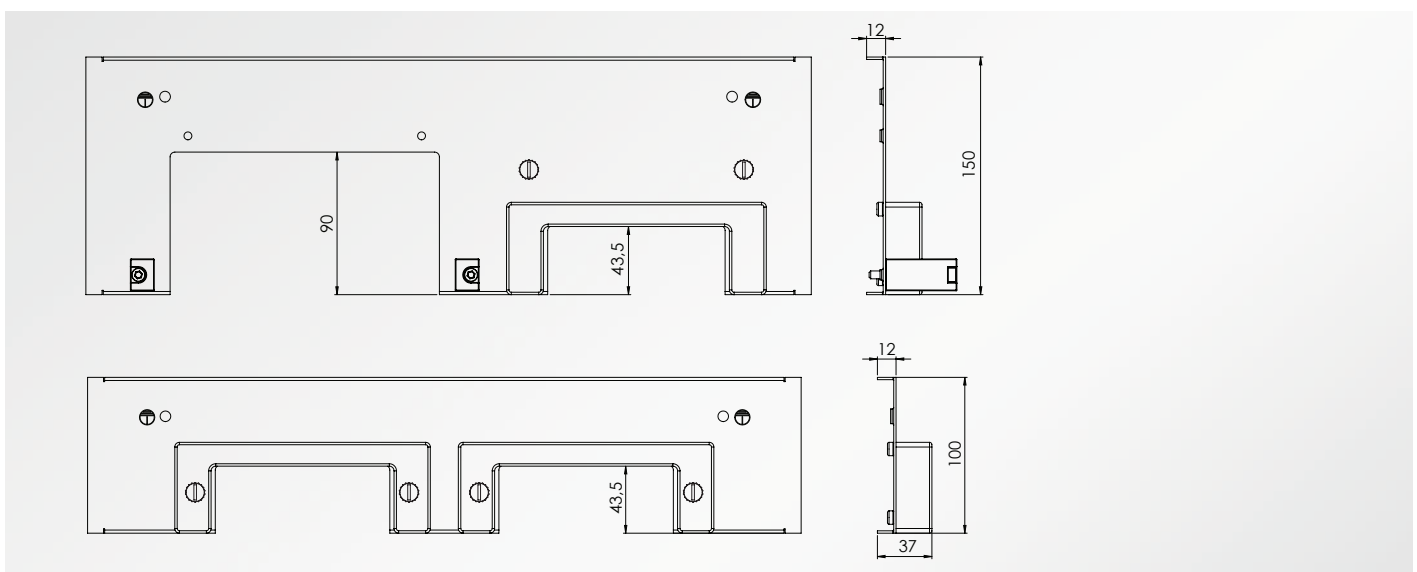

KDR-ESR-TS8 for Rittal TS 8

6  
6.1  
6.2  
6.3  
6.4  
6.5  
6.6

\* in case both fields of the enclosure are equipped, 2 complete gland plates are necessary.

# KDR-ESR-HW

## Enclosure gland plate with slide frames for Häwa enclosures

The KDR-ESR HW is a one-piece plate to be assembled on enclosure bases. Slide frames for the KEL cable entry frames are already pre-assembled. After installing all cables into the KEL frames, they are easily and quickly inserted into the slide frames and fixed. Slide frames which are no longer required are closed with BPK-SNAP blank plates. The gland plate KDR-ESR HW is designed for Häwa enclosures series H395 and series H390.

### Advantages & benefits

- Easy assembly and removal
- Even large connectors can be installed easily
- Retrofitting possible without disconnecting cables. Everything can be built around the cables
- Prepared for the assembly of KDR-EMV-PFM
- No additional sheet metal work required
- The gland plate KDR-ESR HW is designed for Häwa enclosures series H395 and series H390
- Other sizes are available on request

### Specifications

Material	Gland plate: Sheet steel, zinc-plated KDR-ESR Frame: Polyamide (PA))
Flame class	UL 94 V-0, self-extinguishing
IP rating	IP54, with gasket and correct selection of cable entry devices
Temperature	-40°C to + 90°C (static)
Properties	Halogen free, silicone free

### Compatible with

KEL(-U) 24 Cable entry frames	21
KEL-ER 24 Cable entry frames	17
KEL-JUMBO Cable entry frames	56 - 57
BPK-SNAP 24 Blank plates	332

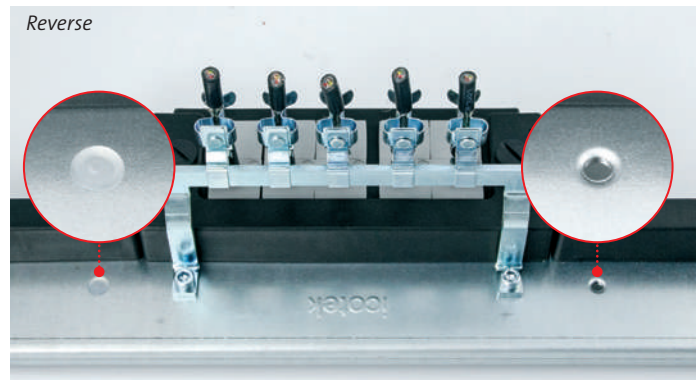

*Reverse*

Prepared for the assembly of KDR-EMV-PFM. The plates are fitted with threaded screw holes (M5), blocked with plugs. These can be easily removed if necessary. By using the KDR-EMV-PFM, there is no need to additionally install a DIN rail/bus bar above the cable entry, which would otherwise have to be attached in order to implement the EMC connection.



Slide frames which are no longer required are closed with BPK-SNAP blank plates

# KDR-ESR-HW

Enclosure gland plate  
with slide frames  
for Häwa enclosures



Type	Enclosure width	Total length gland plate	Sight size of base plate opening	No. of possible cable entries				Order No.
				JUMBO 1	JUMBO 2	KEL(-U) 16 ...	KEL(-U) 24 ...	
KDR-ESR HW for Häwa enclosures series H395 and series H390								
KDR-ESR HW-600 + 1 blank plate	600 mm	427 mm	392 mm	–	–	–	2	44520
KDR-ESR HW-800 + 1 blank plate	800 mm	627 mm	592 mm	–	–	–	3	44521
KDR-ESR HW-800	800 mm	627 mm	592 mm	1	–	–	2	44522
KDR-ESR HW-1000 + 1 blank plate	1000 mm	827 mm	792 mm	–	–	–	4	44523
KDR-ESR HW-1200 + 1 blank plate	1200 mm	1027 mm	992 mm	–	–	–	5	44524
KDR-ESR HW-1200	1200 mm	1027 mm	992 mm	1	–	–	4	44525
KDR-ESR HW-1200	1200 mm	1027 mm	992 mm	–	1	–	4	44526

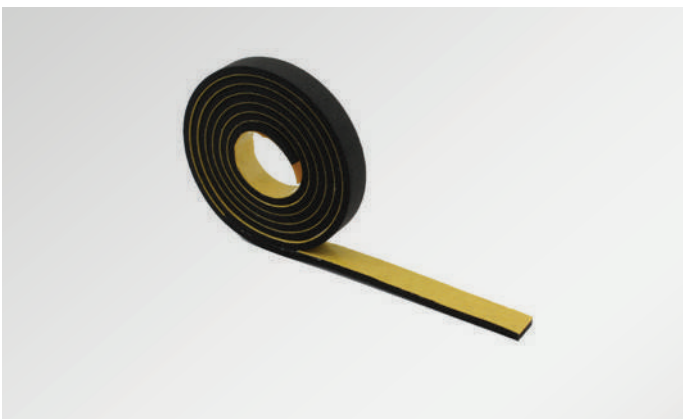

Sealing tape  
Order No. 42999 (L: 1 m)  
Order No. 42999.10000 (L: 10 m)

**i** icotek can also produce enclosure gland plates for numerous other enclosure brands and in other sizes according to your wishes. Ask us at pm@icotek.com!

6  
6.1  
6.2  
6.3  
6.4  
6.5  
6.6

# KDR-ESR-HG2

## Enclosure gland plate with slide frames for Hoffman PROLINE G2



The KDR-ESR-HG2 is a one-piece plate to be assembled on enclosure bases. Slide frames for the KEL cable entry frames are already pre-assembled.

After installing all cables into the KEL frames, they are easily and quickly inserted into the slide frames and fixed. During maintenance, the KEL frames are removed without tools from the slide frames. Due to the combination KDR-ESR-HG2 and KEL cable entry frames, a rating of IP54 is achieved (with correct selection of cable grommets). Slide frames which are no longer required, are closed with BPK-SNAP blank plates.

### Advantages & benefits

- Easy assembly and removal
- During assembly, almost the complete base of the enclosure can be used for installation of cables
- Even large connectors can be installed easily
- The gland plate KDR-ESR-HG2 is designed for Hoffman enclosures PROLINE G2. Other sizes can be supplied on request
- No additional sheet metal work required
- Retrofitting possible without disconnecting cables. Everything can be built around the cables

### Specifications

Material	Gland plate: Sheet steel, zinc-plated KDR-ESR Frame: Polyamide (PA)
Flame class	UL 94 V-0, self-extinguishing
IP rating	IP54, with gasket and correct selection of cable entry devices
Temperature	-40°C to +90°C (static)
Properties	Halogen free, silicone free

### Compatible with

KEL(-U) 16 / 24 Cable entry frames	21
KEL-ER 16 / 24 Cable entry frames	17
KEL-JUMBO Cable entry frames	56 - 57
BPK-SNAP 16 / 24 Blank plates	332

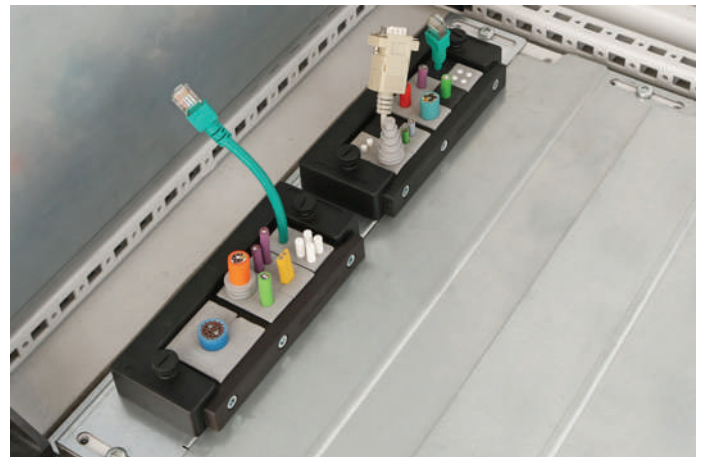

# KDR-ESR-HG2

## Enclosure gland plate with slide frames for Hoffman PROLINE G2



Type	Enclosure width	Total length gland plate	Sight size of base plate opening	No. of possible cable entries			Order No.
				JUMBO 2	KEL(-U) 16 ...	KEL(-U) 24 ...	
KDR-ESR-HG2-600	600 mm / 1200 mm*	432 mm	368 mm	1	1	-	43250
KDR-ESR-HG2-600	600 mm / 1200 mm*	432 mm	368 mm	-	-	2	43251
KDR-ESR-HG2-800	800 mm	632 mm	568 mm	1	-	2	43252
KDR-ESR-HG2-800	800 mm	632 mm	568 mm	-	-	3	43253
KDR-ESR-HG2-1000	1000 mm	832 mm	768 mm	1	-	3	43254
KDR-ESR-HG2-1000	1000 mm	832 mm	768 mm	-	-	4	43255

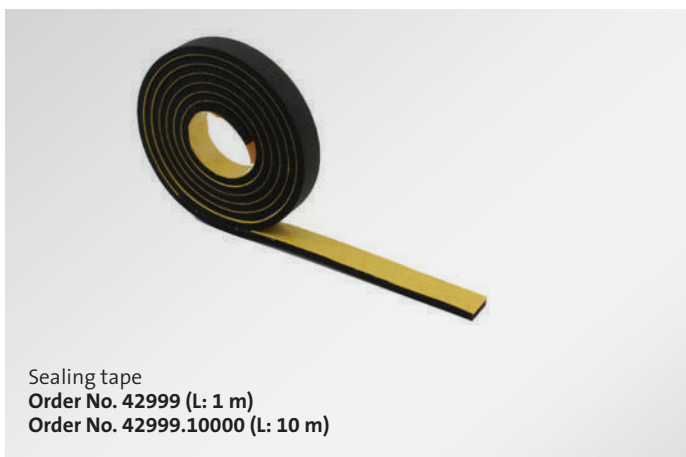
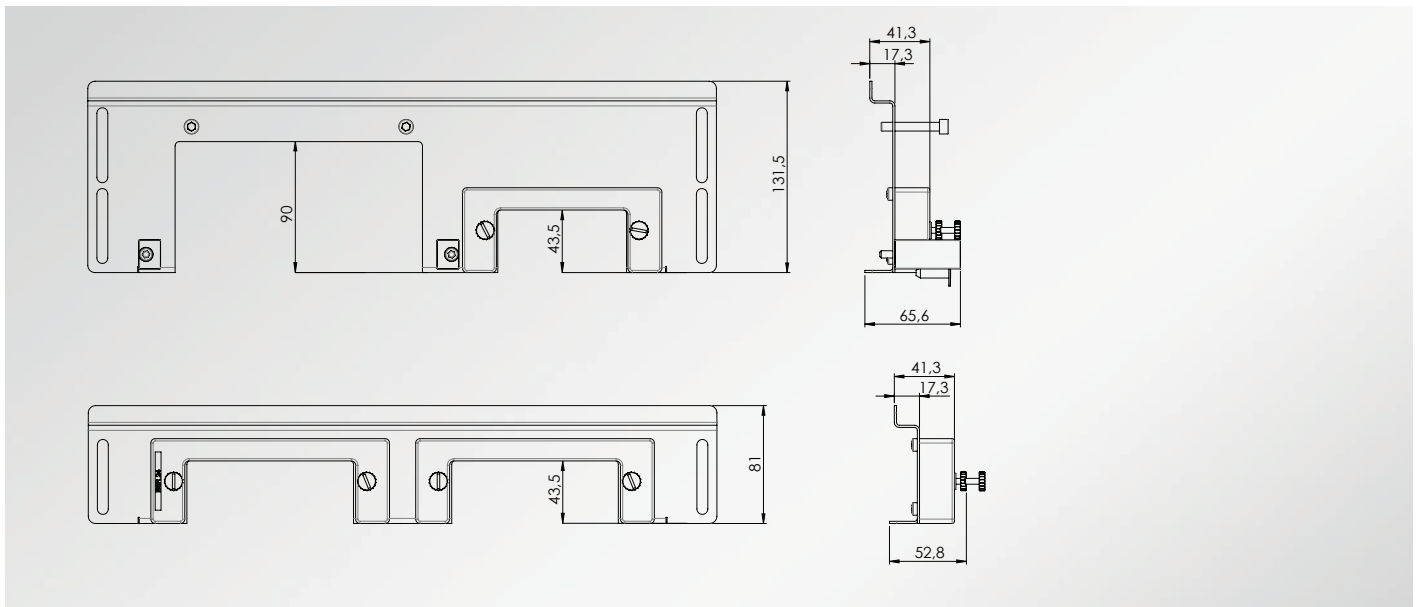

- 6
- 6.1
- 6.2
- 6.3
- 6.4
- 6.5
- 6.6

\* in case both fields of the enclosure are equipped, 2 complete gland plates are necessary.

# KDR 2-VX25 | KDR 2-TS8

## Split Rittal enclosure gland plates

IP54 RoHS compliant Made in Germany

Split, 2-part gland plates KDR 2 with pre-cut holes for KEL and KEL-JUMBO cable entry systems.

Integrated screw holes provide quick and easy installation of KEL frames.

### Advantages & benefits

- During assembly, almost the complete base of the enclosure can be used for installation of cables
- Even large connectors can be installed easily
- The gland plate KDR 2 is designed for Rittal enclosures TS 8 & VX25. Other sizes can be supplied on request
- Retrofitting is possible without disconnecting of cables. All can be installed around the cables.
- No additional sheet metal work required
- Cut-outs, which are no longer required, are covered with metal blank plates Type BPM

### Specifications

Material Sheet steel, zinc-plated

### Compatible with

KEL 24 Cable entry frames	29
KEL-JUMBO Cable entry frames	56 - 57
BPM Blank plates metal	331

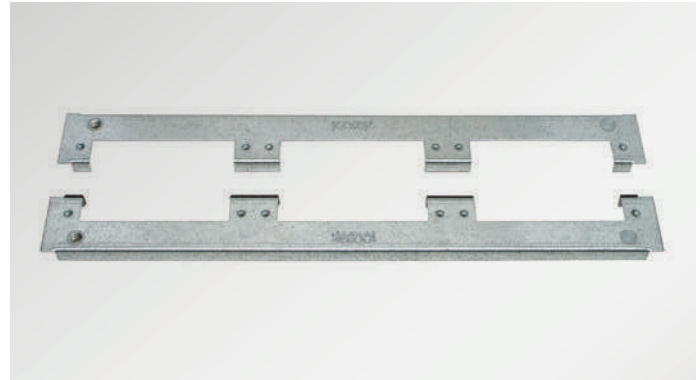

## KDR 2 Assembly

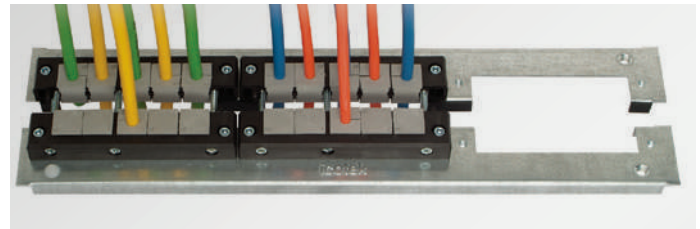

When the cable entry frames are assembled, the KDR gland plates move together for a tight, secure hold of the cable entry systems.

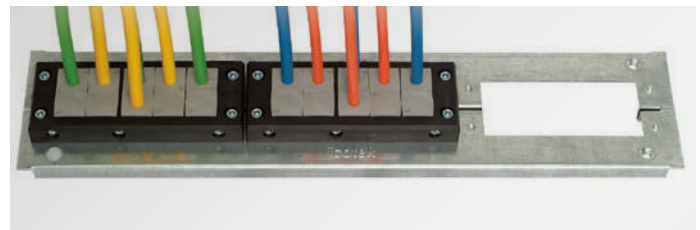

The frame parts with grommets have to be built up before final assembly, i.e. before screwing the system together. Screwing of the cable entry frames tightens both parts of the split gland plate.

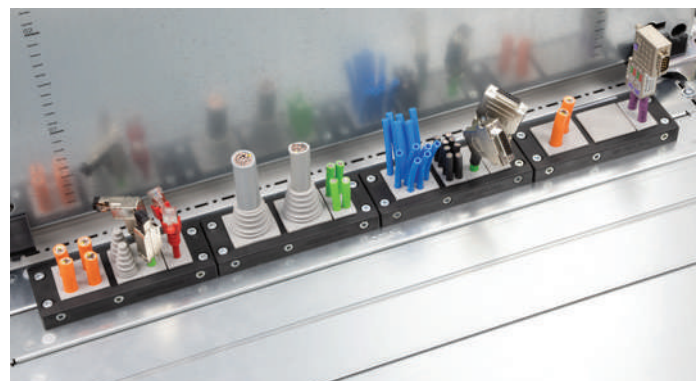
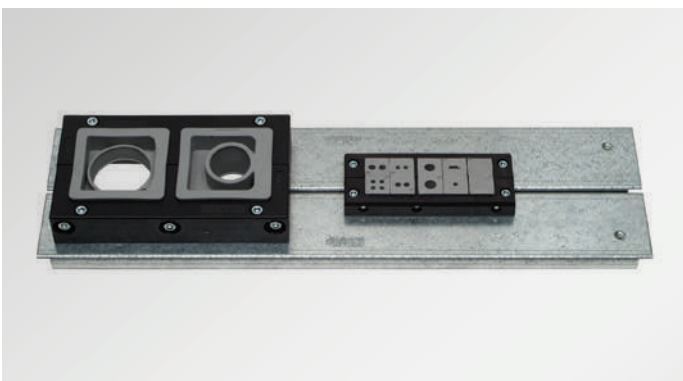



# KDR 2-VX25 | KDR 2-TS8

## Split Rittal enclosure gland plates

Type	Enclosure width	Total length gland plate	Sight size of base plate opening	No. of possible cable entries			Order No.
				JUMBO 1	JUMBO 2	KEL 24 ...	
<b>KDR 2 for Rittal VX25</b>							
KDR 2-VX25-600	600 mm	488 mm	452 mm	-	-	3	44400
KDR 2-VX25-600	600 mm	488 mm	452 mm	1	-	2	44401
KDR 2-VX25-600	600 mm	488 mm	452 mm	-	1	1	44402
KDR 2-VX25-800	800 mm	688 mm	652 mm	-	-	4	44403
KDR 2-VX25-800	800 mm	688 mm	652 mm	1	-	3	44404
KDR 2-VX25-800	800 mm	688 mm	652 mm	-	1	2	44405
KDR 2-VX25-1000	1000 mm* with division bar	438 mm	402 mm	-	-	2	44406
KDR 2-VX25-1000	1000 mm* with division bar	438 mm	402 mm	1	-	1	44407
KDR 2-VX25-1000	1000 mm* with division bar	438 mm	402 mm	-	1	1	44408
KDR 2-VX25-1200	1200 mm*	538 mm	502 mm	-	-	3	44409
KDR 2-VX25-1200	1200 mm*	538 mm	502 mm	1	-	2	44410
KDR 2-VX25-1200	1200 mm*	538 mm	502 mm	-	1	1	44411
<b>KDR 2 for Rittal TS8</b>							
KDR 2-TS8-600	600 mm	458 mm	435 mm	-	-	3	42924
KDR 2-TS8-600	600 mm	458 mm	435 mm	1	-	2	42953
KDR 2-TS8-600	600 mm	458 mm	435 mm	-	1	1	42941
KDR 2-TS8-800	800 mm	658 mm	635 mm	-	-	4	42922
KDR 2-TS8-800	800 mm	658 mm	635 mm	1	-	3	42954
KDR 2-TS8-800	800 mm	658 mm	635 mm	-	1	2	42945
KDR 2-TS8-1000	1000 mm without division bar	858 mm	835 mm	-	-	5	42923
KDR 2-TS8-1000	1000 mm without division bar	858 mm	835 mm	1	-	4	42955
KDR 2-TS8-1000	1000 mm without division bar	858 mm	835 mm	-	1	3	42952
KDR 2-TS8-1000	1000 mm* with division bar	420 mm	398 mm	-	-	2	42958
KDR 2-TS8-1000	1000 mm* with division bar	420 mm	398 mm	1	-	1	42957
KDR 2-TS8-1000	1000 mm* with division bar	420 mm	398 mm	-	1	1	42959
KDR 2-TS8-1200	1200 mm*	518 mm	495 mm	-	-	3	42920
KDR 2-TS8-1200	1200 mm*	518 mm	495 mm	1	-	2	42956
KDR 2-TS8-1200	1200 mm*	518 mm	495 mm	-	1	1	42943

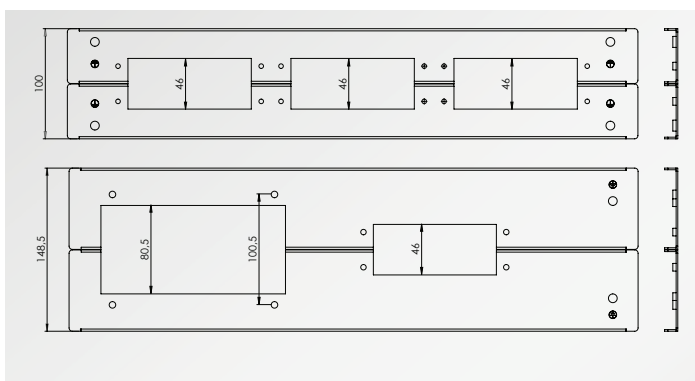

KDR 2-TS8 for Rittal TS 8

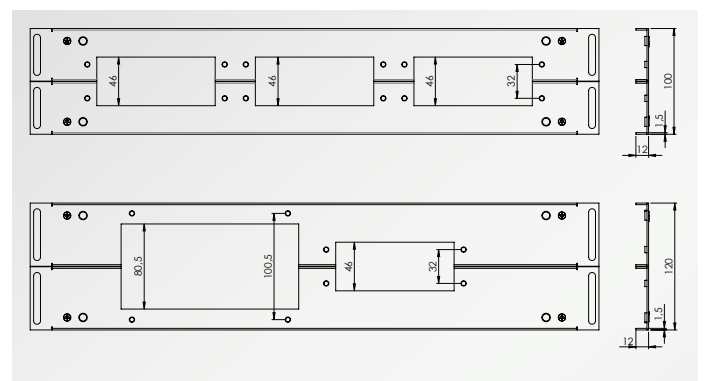

KDR 2-VX25 for Rittal VX25

\* in case both fields of the enclosure are equipped, 2 complete split gland plates are necessary.

# MP

## Module plates

The module plates have cut-outs for fixing the KEL range cable entry systems KEL-FA 24, KEL 24, KEL-U 24, KEL-QUICK 24, KEL-JUMBO, KEL-DPF, KEL-JUMBO flex and KEL-ULTRA flex.

The module plates can be installed on:

- Separation walls by Rittal
- closed enclosure bases and roofs (various manufacturers)
- Bases of Lohmeier enclosures
- Bases of Rittal enclosures via KDR-BMP gland plates

The module blank plate without cut-outs (Order No. 43882) is designed for closing unused cut-outs. This module plate can even be used for self-made cut-outs.

Module plates are supplied with a gasket.

### Specifications

Material	Sheet steel, zinc-plated Aluminium (Order No. 43883, 43899)
Dimension	338 × 168 × 2 mm

### Compatible with

KEL-FA 24 Cable entry frames	25
KEL 24 Cable entry frames	29
KEL-U 24 Cable entry frames	21
KEL-QUICK 24 Cable entry frames	106
KEL-SNAP snap frames	54 - 55
KEL-JUMBO Cable entry frames	56 - 57
KEL-DPF Cable entry grommets	182 - 183
KEL-JUMBO flex Cable entry ins.	185
KEL-ULTRA flex Cable entry ins.	184
KEL-DPR	160 - 161
Blank plates	330 - 332



## MP Applications

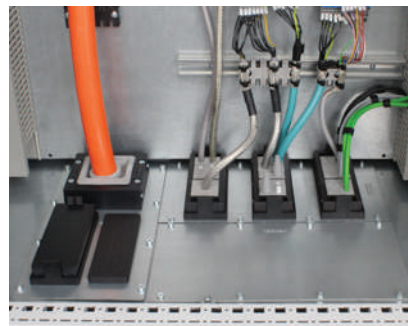

Cable routing via module plates in the base of a Rittal TS8 enclosure. Mounting with icotek gland plate KDR BMP.



Cable routing through the divider panel of a Rittal TS8 baying enclosure system via module plates.

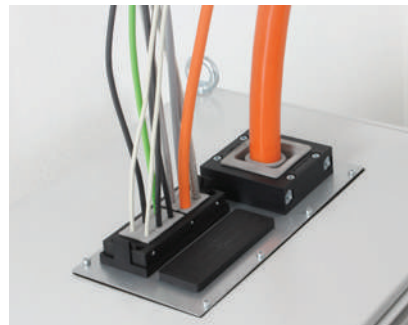

Routing of several cables with and without connectors through a closed enclosure roof via module plates. Cut-out size 314 x 144 mm.



Routing of a rigid supply line through a closed enclosure roof via module plates. Cut-out size 314 x 144 mm.

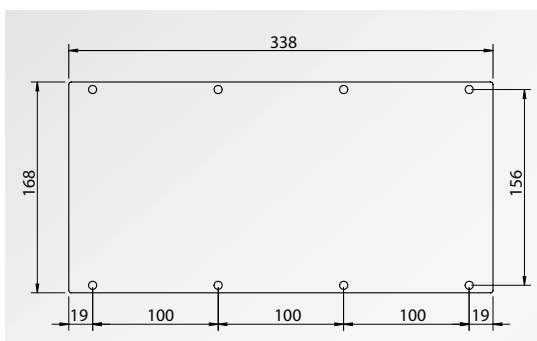

# MP

## Module plates

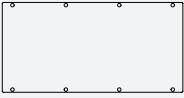
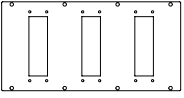
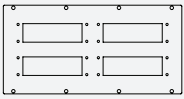
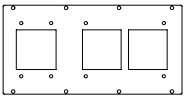
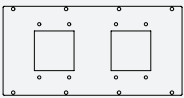
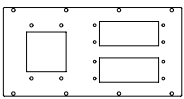
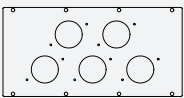
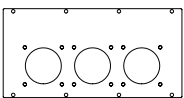
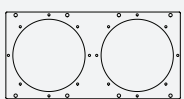
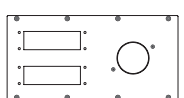
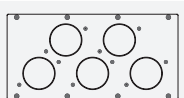
Description	Type	Order No.	Compatible with
	MP 0	43882	Module plate, blank
	MP 1	43891	3× KEL(-FA/-U/-QUICK) 24 x
	MP 2	43890	4× KEL(-FA/-U/-QUICK) 24 x
	MP 3	43886	1× KEL-JUMBO 1 1× KEL-JUMBO 2
	MP 4	43888	2× KEL-JUMBO 1
	MP 5	43887	2× KEL(-FA/-U/-QUICK) 24 x 1× KEL-JUMBO 1
	MP 6	43883	5× cut-out M50 for KEL-DPF or KEL-DPZ
	MP 7	43889	Cut-out 3× KEL-JUMBO flex
	MP 8	43894	Cut-out 2× KEL-ULTRA flex
	MP 10	43896	2× KEL(-FA/-U/-QUICK) 24 x 1× cut-out M63 for KEL-DPF or KEL-DPZ
	MP 11	43899	5× cut-out M63 for KEL-DPF or KEL-DPZ

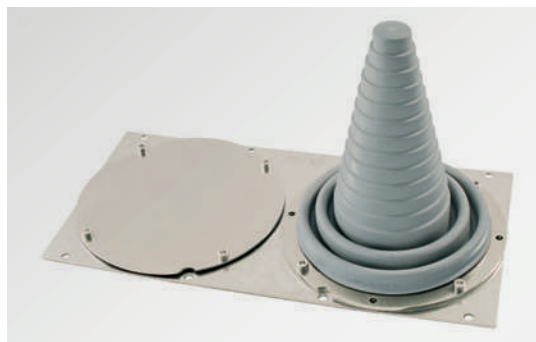
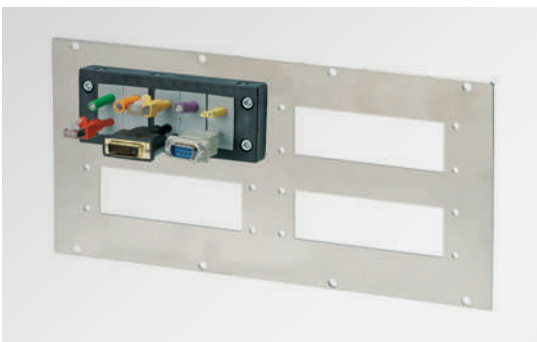

6  
6.1  
6.2  
6.3  
6.4  
6.5  
6.6

# KDR-BMP for VX25

## Enclosure gland plates for module plates

The KDR-BMP gland plates are ideally suited for Rittal VX25 enclosures and can be used instead of the 3 piece standard gland plates. The KDR-BMP gland plates are fixed by screwing.

On KDR-BMP gland plates, our MP Module Plates MP0-MP11 can be easily mounted and used for installation of cable entry components.

Note: The division bar can be removed in Rittal enclosures.

### Advantages & benefits

- Very simple mounting
- No sheet metal work required

### Specifications

Material Sheet steel, zinc-plated  
 IP rating IP54, with gasket and correct selection of cable entry devices

### Compatible with

MP Module plates 314 - 315

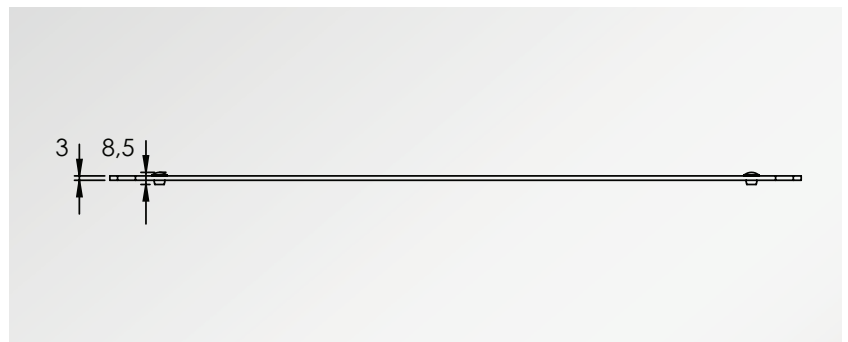
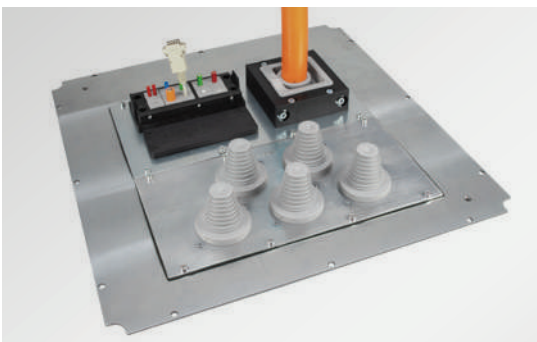
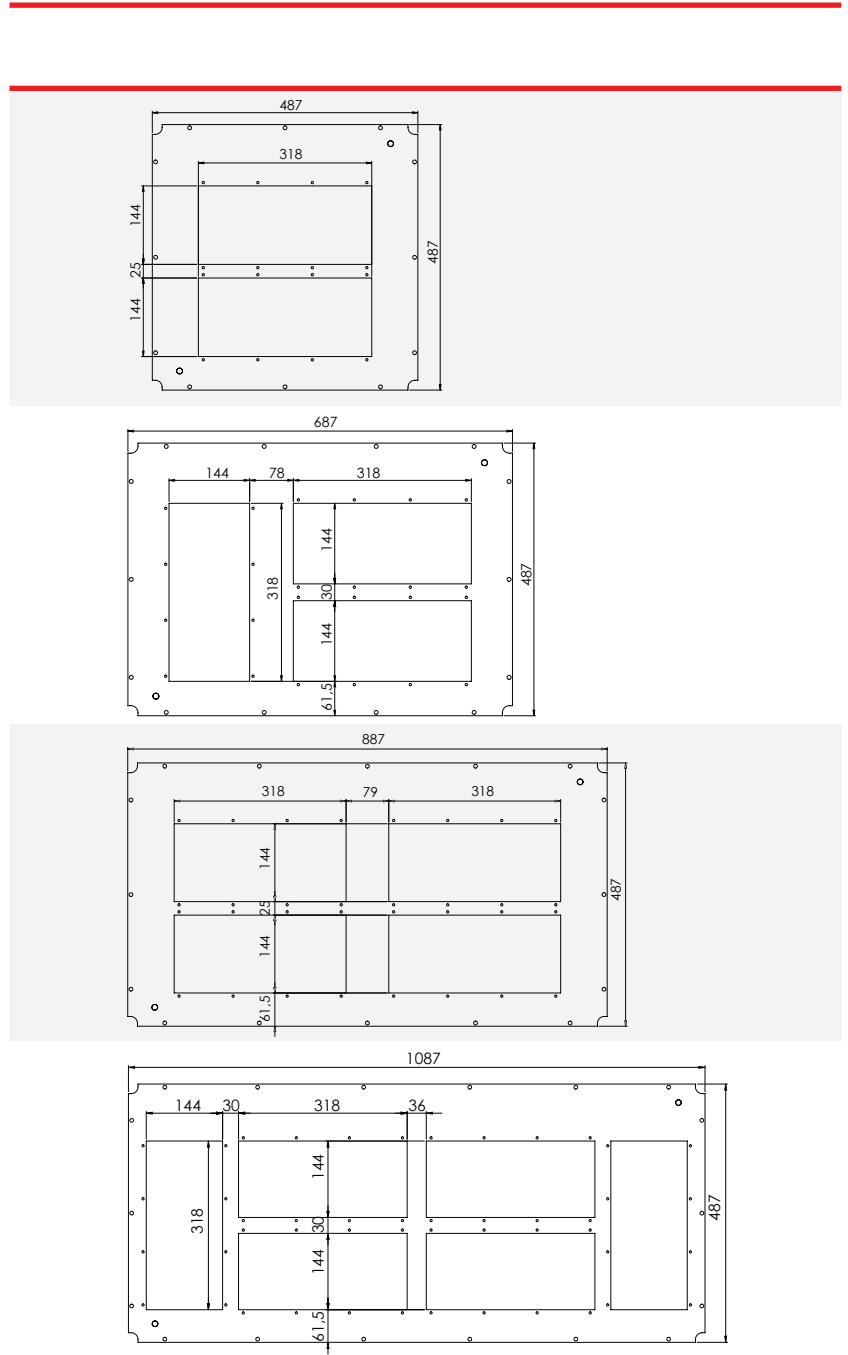

# KDR-BMP for VX25

## Enclosure gland plates for module plates



Type	Enclosure type	Enclosure width	Enclosure depth	No. of cut-outs for module plates	Order No.
KDR-BMP 600/600	VX25	600 mm	600 mm	2	43334
KDR-BMP 800/600	VX25	800 mm	600 mm	3	43340
KDR-BMP 1000/600	VX25	1000 mm without division bar	600 mm	4	43346
KDR-BMP 1200/600	VX25	1200 mm without division bar	600 mm	6	43352

- 6
- 6.1
- 6.2
- 6.3
- 6.4
- 6.5
- 6.6

# KDR-BMP for TS8

## Enclosure gland plates for module plates

The KDR-BMP gland plates are ideally suited for Rittal TS enclosures and can be used instead of the 3 piece standard gland plates. Rittal standard mounting clips are used for fixing the plate.

On KDR-BMP gland plates, our MP Module Plates MP0-MP8 can be easily mounted and used for installation of cable entry components.

### Advantages & benefits

- Very simple mounting
- No sheet metal work required

### Specifications

Material Sheet steel, zinc-plated  
 IP rating IP54, with gasket and correct selection of cable entry devices

### Compatible with

MP Module plates 314 - 315

### Description

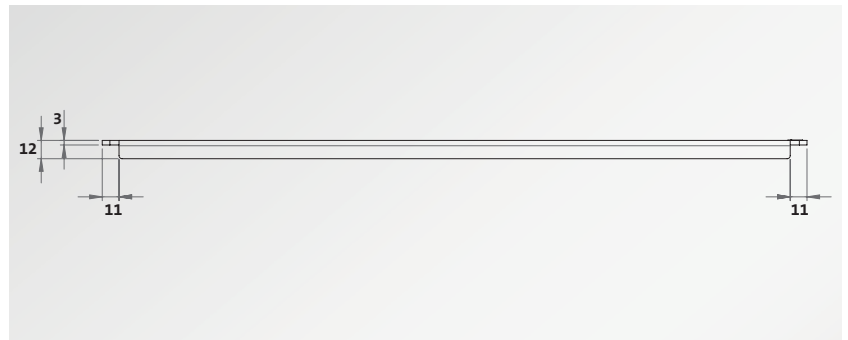
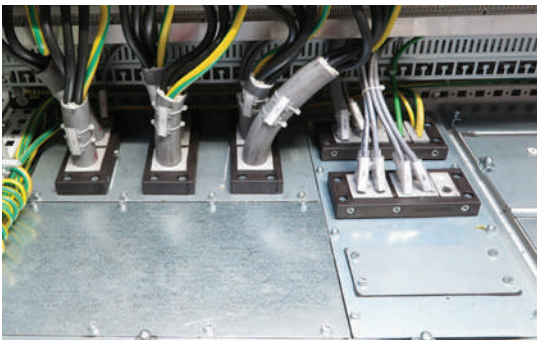
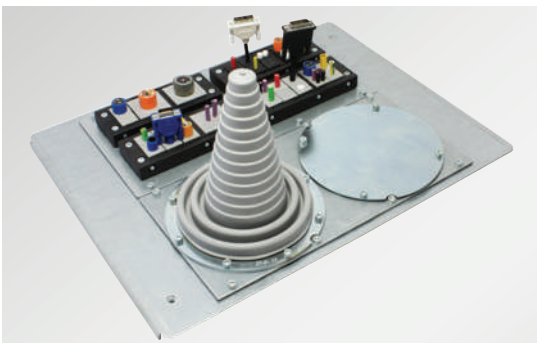
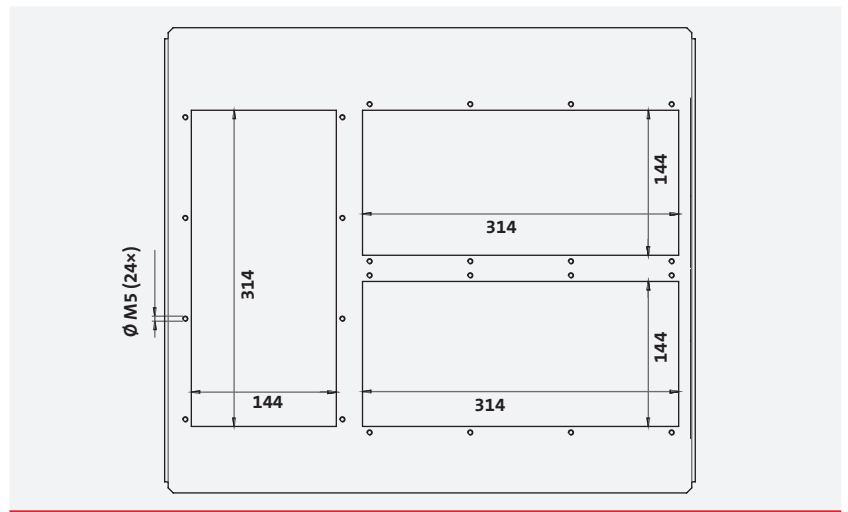
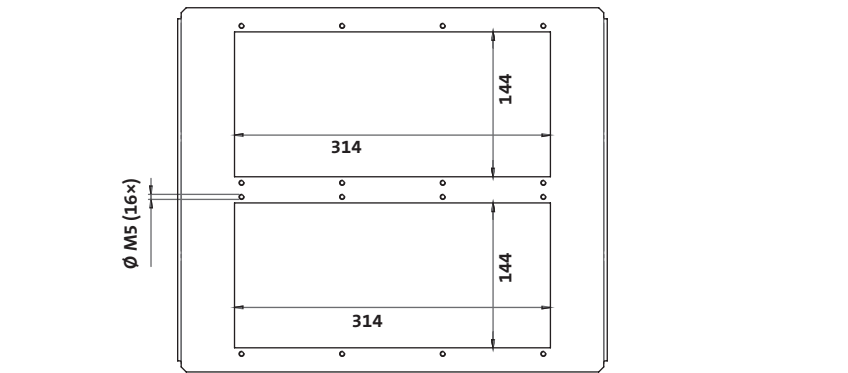
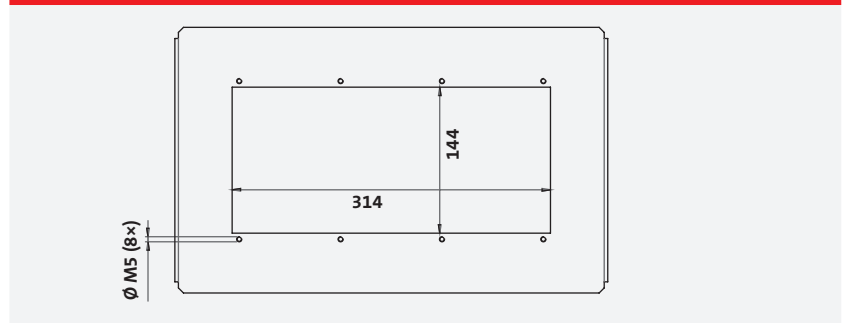

# KDR-BMP for TS8

## Enclosure gland plates for module plates

Type	Enclosure type	Enclosure width	Enclosure depth	No. of cut-outs for module plates	Order No.
KDR-BMP 600/400	TS 8	600 mm	400 mm	1	43300
KDR-BMP 600/500	TS 8	600 mm	500 mm	2	43302
KDR-BMP 600/600	TS 8	600 mm	600 mm	2	43304
KDR-BMP 800/400	TS 8	800 mm	400 mm	1	43306
KDR-BMP 800/500	TS 8	800 mm	500 mm	3	43308
KDR-BMP 800/600	TS 8	800 mm	600 mm	3	43310
KDR-BMP 1000/400	TS 8	1000 mm with division bar	400 mm	1	43312
KDR-BMP 1000/500	TS 8	1000 mm with division bar	500 mm	2	43314
KDR-BMP 1000/600	TS 8	1000 mm with division bar	600 mm	2	43316
KDR-BMP 1200/400	TS 8	1200 mm with division bar	400 mm	1	43318
KDR-BMP 1200/500	TS 8	1200 mm with division bar	500 mm	2 × 3	43320
KDR-BMP 1200/600 for left section	TS 8	1200 mm with division bar	600 mm	3	43322
KDR-BMP 1200/600 for right section	TS 8	1200 mm with division bar	600 mm	3	43324

# FP-AX

## Flange plates for compact enclosures

We supply complete flange plates FP with 112 × 36 mm cut-outs for compact enclosures of the AX series. The cut-outs, as well as the drilling template, conform to the standard cut-outs for 24-pole industrial connectors.

All flange plates are RAL 7035 powder-coated. Please use the gaskets of the standard plates. Enclosures are supplied with gaskets and screws.

We recommend fastening the cable entry systems with a torque of 1.5 - 2.0 Nm.

### Advantages & benefits

- No expensive extra sheet metal work is required
- High cable density is achieved by using KEL-FA, KEL, KEL-U, KEL-QUICK, KEL-DPU, KEL-DPR, KEL-DPZ or KEL-DP
- Reduce labour costs by using cable entry systems compared to the assembly of conventional cable glands

### Specifications

Material Sheet steel, powder coated

### Compatible with

KEL-FA Cable entry frames	24 - 27
KEL Cable entry frames	28 - 37
KEL-U Cable entry frames	20 - 22
KEL-QUICK Cable entry frames	105 - 107
KEL-SNAP Mounting frames	52 - 55
KEL-QTA 24 Cable entry frames	114 - 115
KEL-DPU 24 Cable entry plates	144 - 147
KEL-DPZ 24 Cable entry plates	130 - 137
KEL-DPR Cable entry plates	160 - 161
KEL-DP 24 Cable entry plates	163
KEL-BES	354
KEL-BES-S	355
Blank plates	330 - 332



### Description

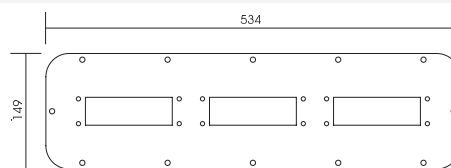
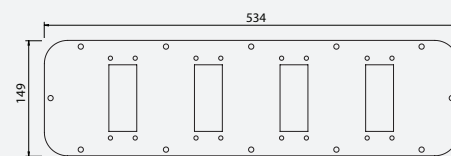
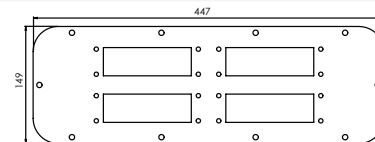
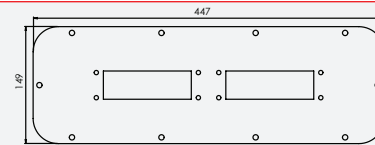
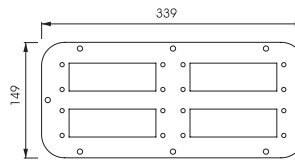
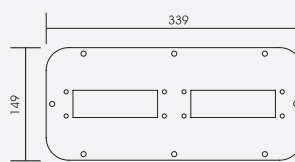
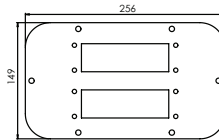
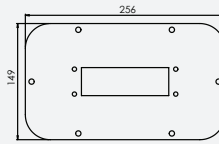

**i** icotek also offers enclosure gland plates with brush strips, see pages 366 – 367. Contact us at [pm@icotek.com](mailto:pm@icotek.com)



# FP-AX

## Flange plates for compact enclosures

Type	Order No. RAL 7035	Compatible with: (Product Group 1)	Compatible with: (Product Group 2)	Size FP	Compatible with	
FP-AX 256 149 with 1 cut-out 36 x 112 mm horizontal	43901	KEL 24   KEL-U 24 KEL-FA 24 KEL-QUICK 24 KEL-QTA 24 KEL-BES 24 KEL-BES-S 24	KEL-DPZ 24 KEL-DPU 24 KEL-DP 24	1	AX 1033.000 AX 1034.000	
FP-AX 256 149 with 2 cut-outs 36 x 112 mm horizontal	43902	KEL 24   KEL-U 24 KEL-FA 24 KEL-QUICK 24 KEL-QTA 24 KEL-BES 24 KEL-BES-S 24	KEL-DPZ 24 KEL-DPU 24 KEL-DP 24	1	AX 1033.000 AX 1034.000	
FP-AX AE 339 149 with 2 cut-outs 36 x 112 mm	43840	KEL 24   KEL-U 24 KEL-FA 24 KEL-QUICK 24 KEL-SNAP 24 KEL-QTA 24 KEL-BES 24 KEL-BES-S 24	KEL-DPZ 24 KEL-DPU 24 KEL-DP 24	2	AX 1031.000 AX 1380.000 AX 1038.000 AX 1077.000 AX 1100.000 AX 1045.000	
FP-AX AE 339 149 with 4 cut-outs 36 x 112 mm	43846	KEL 24   KEL-U 24 KEL-FA 24 KEL-QUICK 24 KEL-QTA 24 KEL-BES 24 KEL-BES-S 24	KEL-DPZ 24 KEL-DPU 24 KEL-DP 24	2	AX 1031.000 AX 1380.000 AX 1038.000 AX 1077.000 AX 1100.000 AX 1045.000	
FP-AX 447 149 with 2 cut-outs 36 x 112 mm horizontal	43903	KEL 24   KEL-U 24 KEL-FA 24 KEL-QUICK 24 KEL-QTA 24 KEL-BES 24 KEL-BES-S 24	KEL-DPZ 24 KEL-DPU 24 KEL-DP 24	3	AX 1050.000 AX 1057.000	
FP-AX 447 149 with 4 cut-outs 36 x 112 mm horizontal	43904	KEL 24   KEL-U 24 KEL-QUICK 24 KEL-QTA 24 KEL-BES 24 KEL-BES-S 24	KEL-DPZ 24 KEL-DPU 24 KEL-DP 24	3	AX 1050.000 AX 1057.000	
FP-AX AE 534 149 with 4 cut-outs 36 x 86 mm	43871	KEL 16   KEL-U 16 KEL-FA 16 KEL-QUICK 16 KEL-SNAP 16 KEL-BES 16 KEL-BES-S 16	KEL-DPZ 16 KEL-DP 16	4	AX 1039.000 AX 1060.000 AX 1054.000 AX 1076.000 AX 1058.000 AX 1090.000	
FP-AX AE 534 149 with 3 cut-outs 36 x 112 mm	43842	KEL 24   KEL-U 24 KEL-FA 24 KEL-QUICK 24 KEL-SNAP 24 KEL-QTA 24 KEL-BES 24 KEL-BES-S 24	KEL-DPZ 24 KEL-DPU 24 KEL-DP 24	4	AX 1039.000 AX 1060.000 AX 1054.000 AX 1076.000 AX 1058.000 AX 1090.000	6 6.1 <b>6.2</b> 6.3 6.4 6.5 6.6

We supply complete flange plates FP with 112 × 36 mm cut-outs for compact enclosures of the AX series. The cut-outs, as well as the drilling template, conform to the standard cut-outs for 24-pole industrial connectors.

All flange plates are RAL 7035 powder-coated. Please use the gaskets of the standard plates. Enclosures are supplied with gaskets and screws.

We recommend fastening the cable entry systems with a torque of 1.5 - 2.0 Nm.

### Advantages & benefits

- No expensive extra sheet metal work is required
- High cable density is achieved by using KEL-FA, KEL, KEL-U, KEL-QUICK, KEL-DPU, KEL-DPZ or KEL-DP
- Reduce labour costs by using cable entry systems compared to the assembly of conventional cable glands

### Specifications

Material Sheet steel, powder coated

### Compatible with

KEL-FA Cable entry frames	24 - 27
KEL Cable entry frames	28 - 37
KEL-U Cable entry frames	20 - 22
KEL-QUICK Cable entry frames	105 - 107
KEL-SNAP Mounting frames	52 - 55
KEL-QTA 24 Cable entry frames	114 - 115
KEL-DPU 24 Cable entry plates	144 - 147
KEL-DPZ 24 Cable entry plates	130 - 137
KEL-DPR Cable entry plates	160 - 161
KEL-DP 24 Cable entry plates	163
KEL-BES	354
KEL-BES-S	355
Blank plates	330 - 332



### Description

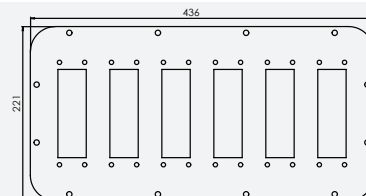
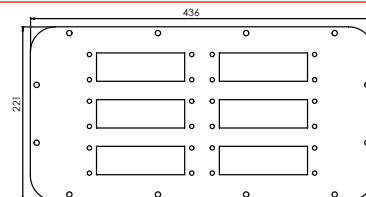
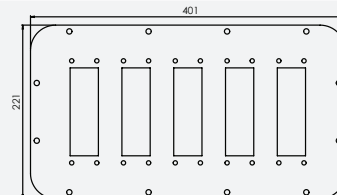
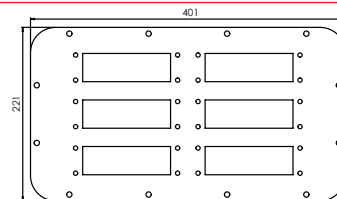
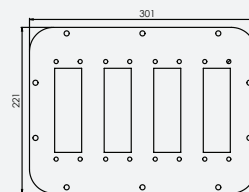
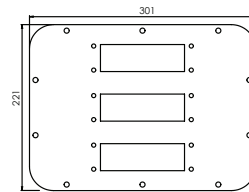
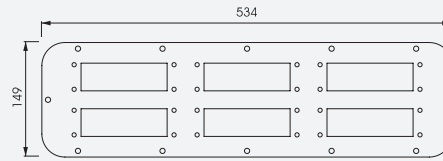

**i** icotek also offers enclosure gland plates with brush strips, see pages 366 – 367. Contact us at [pm@icotek.com](mailto:pm@icotek.com)

# FP-AX

## Flange plates for compact enclosures

Type	Order No. RAL 7035	Compatible with: (Product Group 1)	Compatible with: (Product Group 2)	Size FP	Compatible with
FP-AX AE 534 149 with 6 cut-outs 36 x 112 mm	43848	KEL 24   KEL-U 24 KEL-FA 24 KEL-QUICK 24 KEL-QTA 24 KEL-BES 24 KEL-BES-S 24	KEL-DPZ 24 KEL-DPU 24 KEL-DP 24	4	AX 1039.000 AX 1060.000 AX 1054.000 AX 1076.000 AX 1058.000 AX 1090.000
FP-AX 301 221 with 3 cut-outs 36 x 112 mm horizontal, 3 rows	43905	KEL 24   KEL-U 24 KEL-FA 24 KEL-QUICK 24 KEL-SNAP 24 KEL-QTA 24 KEL-BES 24 KEL-BES-S 24	KEL-DPZ 24 KEL-DPU 24 KEL-DP 24	5	AX 1338.000 AX 1037.000 AX 1073.000 AX 1055.000 AX 1180.000 AX 1280.000 AX 1181.000 AX 1281.000
FP-AX 301 221 with 4 cut-outs 36 x 112 mm vertical, 1 row	43906	KEL 24   KEL-U 24 KEL-FA 24 KEL-QUICK 24 KEL-SNAP 24 KEL-QTA 24 KEL-BES 24 KEL-BES-S 24	KEL-DPZ 24 KEL-DPU 24 KEL-DP 24	5	AX 1338.000 AX 1037.000 AX 1073.000 AX 1055.000 AX 1180.000 AX 1280.000 AX 1181.000 AX 1281.000
FP-AX 401 221 with 6 cut-outs 36 x 112 mm horizontal, 3 rows	43907	KEL 24   KEL-U 24 KEL-FA 24 KEL-QUICK 24 KEL-QTA 24 KEL-BES 24 KEL-BES-S 24	KEL-DPZ 24 KEL-DPU 24 KEL-DP 24	6	AX 1350.000 AX 1130.000 AX 1110.000 AX 1213.000 AX 1114.000 AX 1214.000 AX 1115.000
FP-AX 401 221 with 5 cut-outs 36 x 112 mm vertical, 1 row	43908	KEL 24   KEL-U 24 KEL-FA 24 KEL-QUICK 24 KEL-SNAP 24 KEL-QTA 24 KEL-BES 24 KEL-BES-S 24	KEL-DPZ 24 KEL-DPU 24 KEL-DP 24	6	AX 1350.000 AX 1130.000 AX 1110.000 AX 1213.000 AX 1114.000 AX 1214.000 AX 1115.000
FP-AX 436 221 with 6 cut-outs 36 x 112 mm horizontal, 3 rows	43909	KEL 24   KEL-U 24 KEL-FA 24 KEL-QUICK 24 KEL-QTA 24 KEL-BES 24 KEL-BES-S 24	KEL-DPZ 24 KEL-DPU 24 KEL-DP 24	7	AX 1339.000 AX 1360.000 AX 1376.000 AX 1260.000 AX 1116.000 AX 1059.000 AX 1091.000 AX 1261.000
FP-AX 436 221 with 6 cut-outs 36 x 112 mm vertical, 1 row	43910	KEL 24   KEL-U 24 KEL-FA 24 KEL-QUICK 24 KEL-SNAP 24 KEL-QTA 24 KEL-BES 24 KEL-BES-S 24	KEL-DPZ 24 KEL-DPU 24 KEL-DP 24	7	AX 1339.000 AX 1360.000 AX 1376.000 AX 1260.000 AX 1116.000 AX 1059.000 AX 1091.000 AX 1261.000

6  
6.1  
6.2  
6.3  
6.4  
6.5  
6.6

The FP flange plates type KX/KL, designed to fit the Rittal KX/KL series terminal boxes, are installed in combination with a cable entry system for either pre-terminated or standard cables. FP flange plates are pre-cut, pre-drilled and painted for easy and quick installation of icotek cable routing products.

We recommend fastening the cable entry systems with a torque of 1.5 – 2.0 Nm.

**Specifications**

Material Sheet steel, powder coated

**Compatible with**

KEL-FA Cable entry frames	24 - 27
KEL Cable entry frames	28 - 37
KEL-U Cable entry frames	20 - 22
KEL-QUICK Cable entry frames	105 - 107
KEL-SNAP Mounting frames	52 - 55
KEL-QTA Cable entry frames	114 - 115
KEL-DPU Cable entry plates	144 - 147
KEL-DPZ Cable entry plates	130 - 137
KEL-DPR Cable entry plates	160 - 161
KEL-DP Cable entry plates	163
KEL-BES	354
KEL-BES-S	355
Blank plates	330 - 332

**Description**

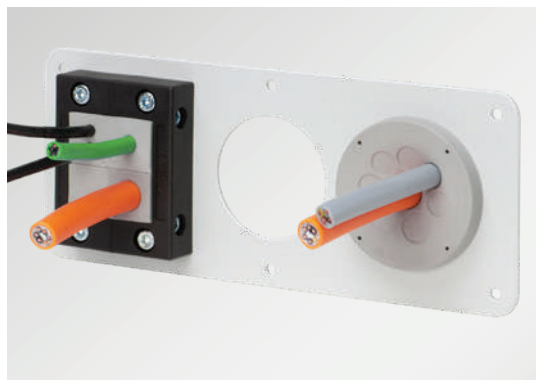
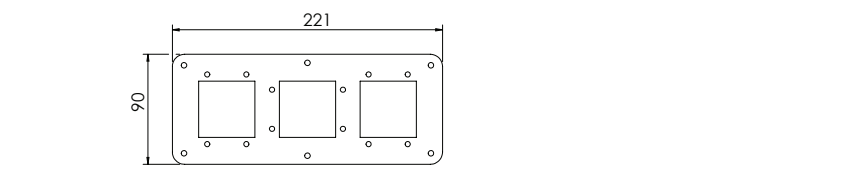
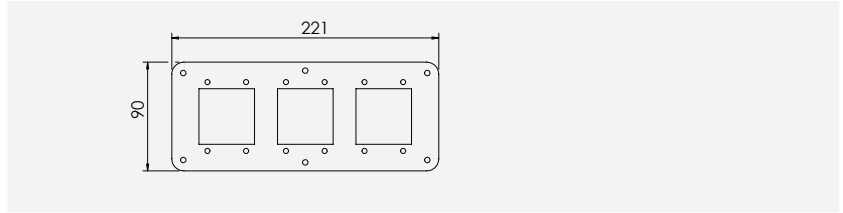
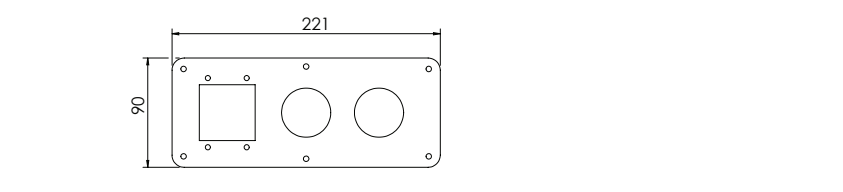
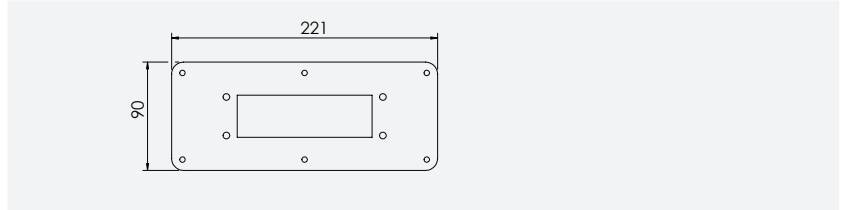
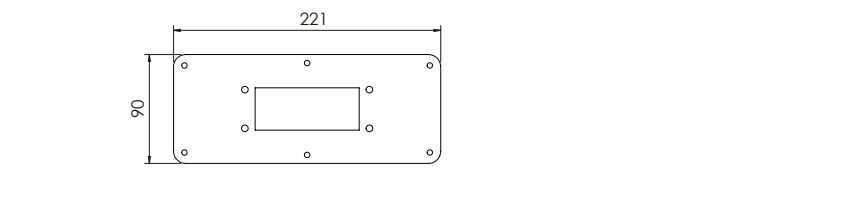
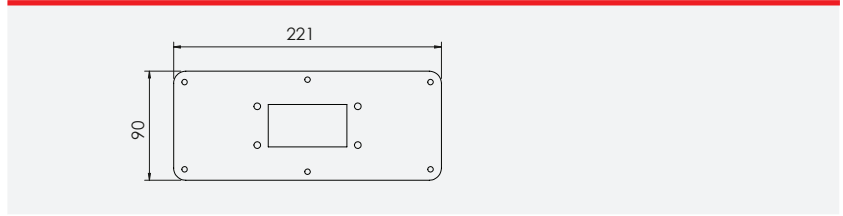

# FP-KX/KL

## Flange plates for terminal boxes

Type	Order No. RAL 7035	Flange plates compatible with	Size FP	Compatible with
FP-KX/KL 221x90 10 with 1 cut-out 36 x 65 mm	43853	KEL 10   KEL-U 10 KEL-FA 10 KEL-QUICK 10 KEL-SNAP 10 KEL-SNAP-S 10 KEL-DPZ 10 KEL-DP 10 KEL-BES(-S) 10	2	Terminal boxes Type KL KX 1536.000 KX 1537.000 KX 1538.000 KX 1539.000 KX 1540.000 KX 1541.000
FP-KX/KL 221x90 16 with 1 cut-out 36 x 86 mm	43855	KEL 16   KEL-U 16 KEL-FA 16 KEL-QUICK 16 KEL-SNAP 16 KEL-SNAP-S 16 KEL-DPZ 16 KEL-DP 16 KEL-BES(-S) 16	2	Terminal boxes Type KL KX 1536.000 KX 1537.000 KX 1538.000 KX 1539.000 KX 1540.000 KX 1541.000
FP-KX/KL 221x90 24 with 1 cut-out 36 x 112 mm	43834	KEL 24   KEL-U 24 KEL-FA 24 KEL-QUICK 24 KEL-SNAP 24 KEL-QTA 24 KEL-DPZ 24 KEL-DPU 24 KEL-DP 24 KEL-BES(-S) 24	2	Terminal boxes Type KL KX 1536.000 KX 1537.000 KX 1538.000 KX 1539.000 KX 1540.000 KX 1541.000
FP-KX/KL 221x90 A with 3 cut-outs	43852	KEL-B   KEL-U-B KEL-QUICK-B KEL-SNAP-B KEL-DPZ-B KEL-DPZ 40 KEL-DPF 40	2	Terminal boxes Type KL KX 1536.000 KX 1537.000 KX 1538.000 KX 1539.000 KX 1540.000 KX 1541.000
FP-KX/KL 221x90 B with 3 cut-outs 46 x 46 mm	43854	Use with: 2x KEL-SNAP-B and 1x KEL-DPZ-B	2	Terminal boxes Type KL KX 1536.000 KX 1537.000 KX 1538.000 KX 1539.000 KX 1540.000 KX 1541.000
FP-KX/KL 221x90 C with 3 cut-outs 46 x 46 mm	43856	KEL-B   KEL-U-B KEL-QUICK-B KEL-DPZ-B	2	Terminal boxes Type KL KX 1536.000 KX 1537.000 KX 1538.000 KX 1539.000 KX 1540.000 KX 1541.000



IP65 cable entry plate for Rittal KX and KL:  
KEL-DPZ-KX/KL page 172

6  
6.1  
6.2  
6.3  
6.4  
6.5  
6.6

# FP-AE

## Flange plates for compact enclosures

We supply complete flange plates FP with 112 × 36 mm cut-outs for compact enclosures of the AE series. The cut-outs, as well as the drilling template, conform to the standard cut-outs for 24-pole industrial connectors.

All flange plates are RAL 7035 powder-coated. Please use the gaskets of the standard plates. Enclosures are supplied with gaskets and screws.

We recommend fastening the cable entry systems with a torque of 1.5 - 2.0 Nm.

### Advantages & benefits

- No expensive extra sheet metal work is required
- High cable density is achieved by using KEL-FA, KEL, KEL-U, KEL-QUICK, KEL-DPU, KEL-DPZ or KEL-DP
- Reduce labour costs by using cable entry systems compared to the assembly of conventional cable glands

### Specifications

Material Sheet steel, powder coated

### Compatible with

KEL-FA Cable entry frames	24 - 27
KEL Cable entry frames	28 - 37
KEL-U Cable entry frames	20 - 22
KEL-QUICK Cable entry frames	105 - 107
KEL-SNAP Mounting frames	52 - 55
KEL-QTA Cable entry frames	114 - 115
KEL-DPU Cable entry plates	144 - 147
KEL-DPZ Cable entry plates	130 - 137
KEL-DPR Cable entry plates	160 - 161
KEL-DP Cable entry plates	163
KEL-BES	354
KEL-BES-S	355
Blank plates	330 - 332



### Description

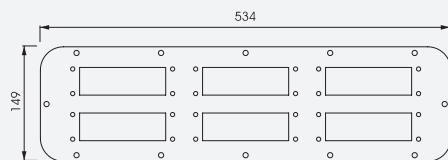
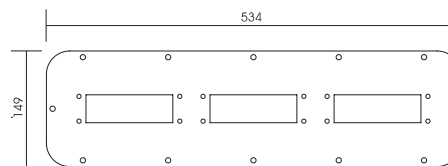
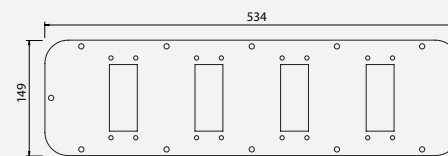
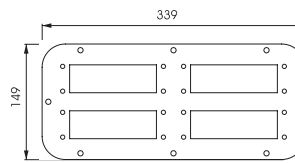
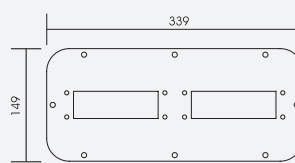
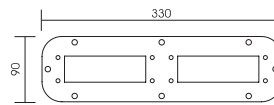
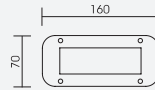

# FP-AE

## Flange plates for compact enclosures



Type	Order No. RAL 7035	Compatible with: (Product Group 1)	Compatible with: (Product Group 2)	Size FP	Compatible with
FP-AE 160 70 with 1 cut-out 36 x 112 mm	43836	KEL-QTA 24	KEL-DP 24	1	AE 1032 AE 1035
FP-AE-24 330 90 with 2 cut-outs 36 x 112 mm	43838	KEL 24   KEL-U 24 KEL-QUICK 24 KEL-QTA 24 KEL-BES 24 KEL-BES-S 24	KEL-DPZ 24 KEL-DPU 24 KEL-DP 24	3	AE 1030 AE 1031 AE 1038 AE 1380
FP-AE-16 330 90 with 2 cut-outs 36 x 86 mm	43861	KEL 16   KEL-U 16 KEL-QUICK 16 KEL-BES 16 KEL-BES-S 16	KEL-DPZ 16 KEL-DP 16	3	
FP-AX AE 339 149 with 2 cut-outs 36 x 112 mm	43840	KEL 24   KEL-U 24 KEL-QUICK 24 KEL-SNAP 24 KEL-QTA 24 KEL-BES 24 KEL-BES-S 24	KEL-DPZ 24 KEL-DPU 24 KEL-DP 24	4	AE 1037 AE 1045 AE 1050 AE 1057 AE 1100 AE 1110 AE 1114 AE 1130 AE 1213 AE 1338 AE 1350
FP-AX AE 339 149 with 4 cut-outs 36 x 112 mm	43846	KEL 24   KEL-U 24 KEL-QUICK 24 KEL-QTA 24 KEL-BES 24 KEL-BES-S 24	KEL-DPZ 24 KEL-DPU 24 KEL-DP 24	4	CS 9751.125 CS 9751.145 CS 9751.165 CS 9752.125 TP 6710 TP 6712 TP 6714 TP 6716
FP-AX AE 534 149 with 4 cut-outs 36 x 86 mm	43871	KEL 16   KEL-U 16 KEL-QUICK 16 KEL-SNAP 16 KEL-BES 16 KEL-BES-S 16	KEL-DPZ 16 KEL-DP 16	5	AE 1039 AE 1054 AE 1055 AE 1058 AE 1060 AE 1073 AE 1076 AE 1077 AE 1090 AE 1180 AE 1260 AE 1280 AE 1339 AE 1360 AE 1376 AE 1958 EL 1919 EL 1926
FP-AX AE 534 149 with 3 cut-outs 36 x 112 mm	43842	KEL 24   KEL-U 24 KEL-QUICK 24 KEL-SNAP 24 KEL-QTA 24 KEL-BES 24 KEL-BES-S 24	KEL-DPZ 24 KEL-DPU 24 KEL-DP 24	5	IN 1076.290
FP-AX AE 534 149 with 6 cut-outs 36 x 112 mm	43848	KEL 24   KEL-U 24 KEL-QUICK 24 KEL-QTA 24 KEL-BES 24 KEL-BES-S 24	KEL-DPZ 24 KEL-DPU 24 KEL-DP 24	5	TP 6711 TP 67113 TP 6715 TP 6717

6  
6.1  
**6.2**  
6.3  
6.4  
6.5  
6.6

The FP flange plates type BG, designed to fit the Rittal BG series enclosures, have up to 3 cut-outs that match the dimensions of the standard cut-outs for the 24-pole industrial connectors. These flange plates are installed in combination with a cable entry system for either pre-terminated cables (KEL-FA 24, KEL 24, KEL-U 24 or KEL-QUICK 24) or standard cables (KEL-DPZ 24, KEL-DPU 24 or KEL-DP 24).

We recommend fastening the cable entry systems with a torque of 1.5 – 2.0 Nm.

**Specifications**

Material Sheet steel, powder coated

**Compatible with**

KEL-FA 24 Cable entry frames	29
KEL 24 Cable entry frames	25
KEL-U 24 Cable entry frames	21
KEL-QUICK 24 Cable entry frames	106
KEL-SNAP Mounting frames	52-55
KEL-QTA 24 Cable entry frames	114
KEL-DPU 24 Cable entry plates	145 - 147
KEL-DPZ 24 Cable entry plates	148 - 150
KEL-DPR Cable entry plates	160 - 161
KEL-DP 24 Cable entry plates	163
Blank plates	330-332

**Description**

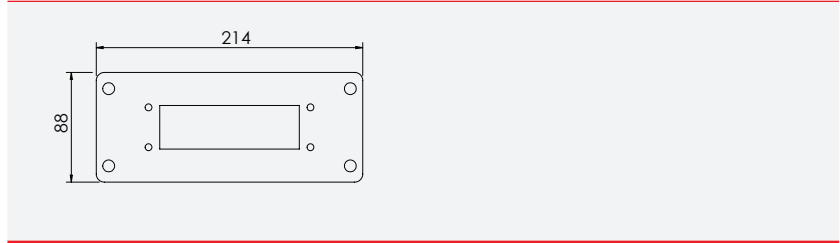
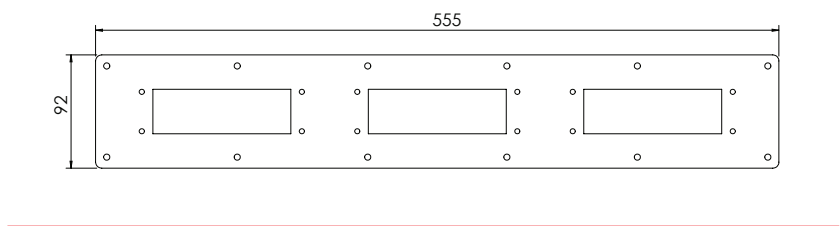
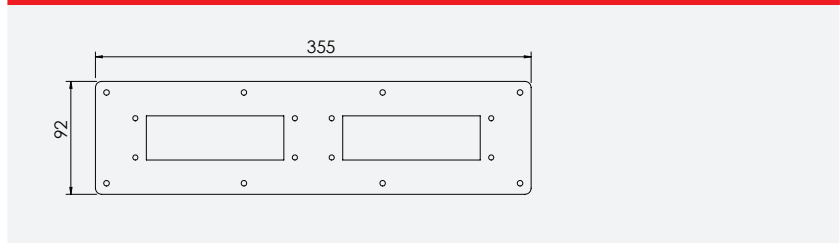



Type	Order No. RAL 7035	Flange plates compatible with	Size FP.	Compatible with
FP-BG 355x92 with 2 cut-outs 36 x 112 mm	43866	KEL 24   KEL-U 24 KEL-FA 24 KEL-QUICK 24 KEL-SNAP 24 KEL-QTA 24 KEL-DPZ 24 KEL-DPR 24 KEL-DPU 24 KEL-DP 24 KEL-BES(-S) 24	-	BG 1558.510
FP-BG 555x92 with 3 cut-outs 36 x 112 mm	43865	KEL 24   KEL-U 24 KEL-FA 24 KEL-QUICK 24 KEL-SNAP 24 KEL-QTA 24 KEL-DPZ 24 KEL-DPR 24 KEL-DPU 24 KEL-DP 24 KEL-BES(-S) 24	6	BG 1050.900 BG 1559.510 IN 1510.280
FP-FL 21 with 1 cut-out 36 x 112 mm	43832	KEL 24   KEL-U 24 KEL-FA 24 KEL-QUICK 24 KEL-SNAP 24 KEL-QTA 24 KEL-DPZ 24 KEL-DPR 24 KEL-DPU 24 KEL-DP 24 KEL-BES(-S) 24	-	Fibox plates

# BPK

## Blank plates, plastic



BPK Blank plates seal cut-outs for standard 10-pole / 16-pole / 24-pole industrial connectors with IP rating up to IP64.

Plastic blank plates are available in two different versions:

Type BPK: Blank plates for screw connection  
 Type BPK-RF A: Blank plates for snapping into metal sheet plates up to a thickness from 1.5 to 3 mm

### Advantages & benefits

- Fast mounting of the blank plates BPK-RF range by snapping into the cut-out
- Integrated circular sealing (up to IP66)

### Specifications

Material Polypropylene (PP)  
 Circular sealing: Elastomer  
 Flame class UL 94 V-0  
 IP rating BPK: IP66 (certified acc. to EN 60529)  
 BPK-RF A: IP54  
 Temperature -30°C to +140°C (static)  
 Properties Halogen free, silicone free

### Compatible with

FP Flange plates 320 - 329

Type	Order No.	Blank plate for KEL cut-out	Dimensions	PU
<b>BPK Blank plates for screw connection:</b>				
BPK-B	42010	... -B	76 × 53 mm	10
BPK 10	42015	... 10	101 × 53 mm	10
BPK 16	42016	... 16	121 × 53 mm	10
BPK 24	42024	... 24 KEL-FG-ER A   KEL-FG-A	148 × 53 mm	10
<b>BPK Blank plates for snapping into cut-outs:</b>				
BPK-B-RF A	42010.002	... -B	76 × 53 mm	10
BPK 10-RF A	42015.002	... 10	101 × 53 mm	10
BPK 16-RF A	42016.002	... 16	121 × 53 mm	10
BPK 24-RF A	42024.002	... 24 KEL-FG-ER A   KEL-FG-A	148 × 53 mm	10
BPK-JFX	42620	KEL-JUMBO flex	88 × 88 mm	5



BPK



BPK-RF



BPK-RF: Snap function, tool-free assembly



BPK: screwable

# BPM

## Blank plates, metal

Blank plates to close cut-outs for standard 6-pole/10-pole/16-pole/24-pole industrial connectors.

Blank plates are supplied with a gasket.

### Specifications

Material	Steel, zinc-plated Width 2 mm
IP rating	IP66

### Compatible with

KDR 2 Split gland plates	312 - 313
FP Flange plates	320 - 329
MP Module plates	314 - 315

Type	Order No.	Blank plate for KEL cut-out	Dimensions	PU
BPM-E2	42048	... -E2	73 × 39.5 mm	10
BPM-E3	42049	... -E3	98 × 39.5 mm	10
BPM-E4	42050	... -E4	120 × 39.5 mm	10
BPM-E5	42051	... -E5	147 × 39.5 mm	10
BPM-B BPM-B V2A	42013 41996	... -B	75 × 58 mm	10
BPM 6 BPM 6 V2A	42011 41991	... 6	90 × 52 mm	10
BPM 10 BPM 10 V2A	42014 41992	... 10	99 × 58 mm	10
BPM-FG-B	42012	KEL-FG-B	80 × 58 mm	10
BPM 16 BPM 16 V2A	42025 41994	... 16	118 × 56 mm	10
BPM 16-E	42023	KEL 16-E	120 x 87 mm	1
BPM 16-MT	42026	KEL 16-MT	120 x 102 mm	1
BPM 16-2MT	42031	KEL 16-2MT	120 x 146 mm	1
BPM 24 BPM 24 V2A	42027 41995	... 24	145 × 56 mm	10
BPM 24-E	42029	KEL 24-E	143 x 83 mm	1
BPM 24-MT	42028	KEL 24-MT	147 × 102 mm	1
BPM-JUMBO flex	42033	KEL-JUMBO flex	88 × 88 mm	1
BPM-JUMBO 1	42030	KEL-JUMBO 1	116 × 110 mm	1
BPM-JUMBO 2	42032	KEL-JUMBO 2	200 × 116 mm	1
BPM-ULTRA	42633	KEL-ULTRA flex	∅ 168 mm Width: 1.5 mm	1



# BPK-SNAP

## Blank plates for KEL-SNAP frames



Blank plate BPK-SNAP to close cut-outs of pre-assembled KEL-SNAP frames.

A snap frame can be closed, i.e. during transport to avoid entry of dust, as long as a KEL frame is not mounted.

The BPK-SNAP blank plate is simply snapped on the KEL frame. There is no tool needed to remove it.

BPK-SNAP 16 and BPK-SNAP 24 for closing cut-outs of the KEL-SNAP mounting frames and unused slide frames of the KDR-ESR gland plates.

### Specifications

Material	Polyamide (PA)
Flame class	UL 94 V-0
IP rating	IP54
Temperature	-40°C to +80°C (static)
Properties	Halogen free, silicone free

### Compatible with

KEL-SNAP Mounting frames	52 - 55
KDR-ESR Gland plate with Slide frames	300 - 311

Type	Order No.	Blank plate compatible with	Dimensions l x b x h	PU
BPK-SNAP-B	42003	KEL-SNAP-B4	58 × 72.8 × 17 mm	10
BPK-SNAP 10	42004	KEL-SNAP 10	58 × 98.3 × 17 mm	10
BPK-SNAP 16	42007	KEL-SNAP 16	58 × 120 × 17 mm	10
BPK-SNAP 24	42017	KEL-SNAP 24	58 × 147 × 17 mm	10
BPK-SNAP 24-E	42008	KEL-SNAP 24-E	83 × 147 × 17 mm	10



# Control panel construction

Control panel construction is required in numerous areas: from building technology and electrical engineering to industrial automation and energy distribution through to network technology. In these areas, electrical engineers are confronted with deadlines and cost pressure. High demands are placed on individual control panel solutions, short production time and high quality at low costs.

icotek offers highly efficient and cost-effective solutions for every control panel application in the fields of cable entry, cable management and EMC cable shielding.

- 1 Cable entry frames and plates**  
Product groups 1 and 2  
Page 10 – 174
- 2 Gland plates, flange plates, accessories**  
Product group 6  
Page 294 – 349
- 3 Strain relief and cable routing**  
Product group 3  
Page 186 – 219
- 4 EMC solutions**  
Product group 4  
Page 220 – 283
- 5 CONFIX Cable conduit system**  
Product group 5  
Page 284 – 293
- 6 Cable pass-through with brush seal**  
Product group 7  
Page 350 – 369

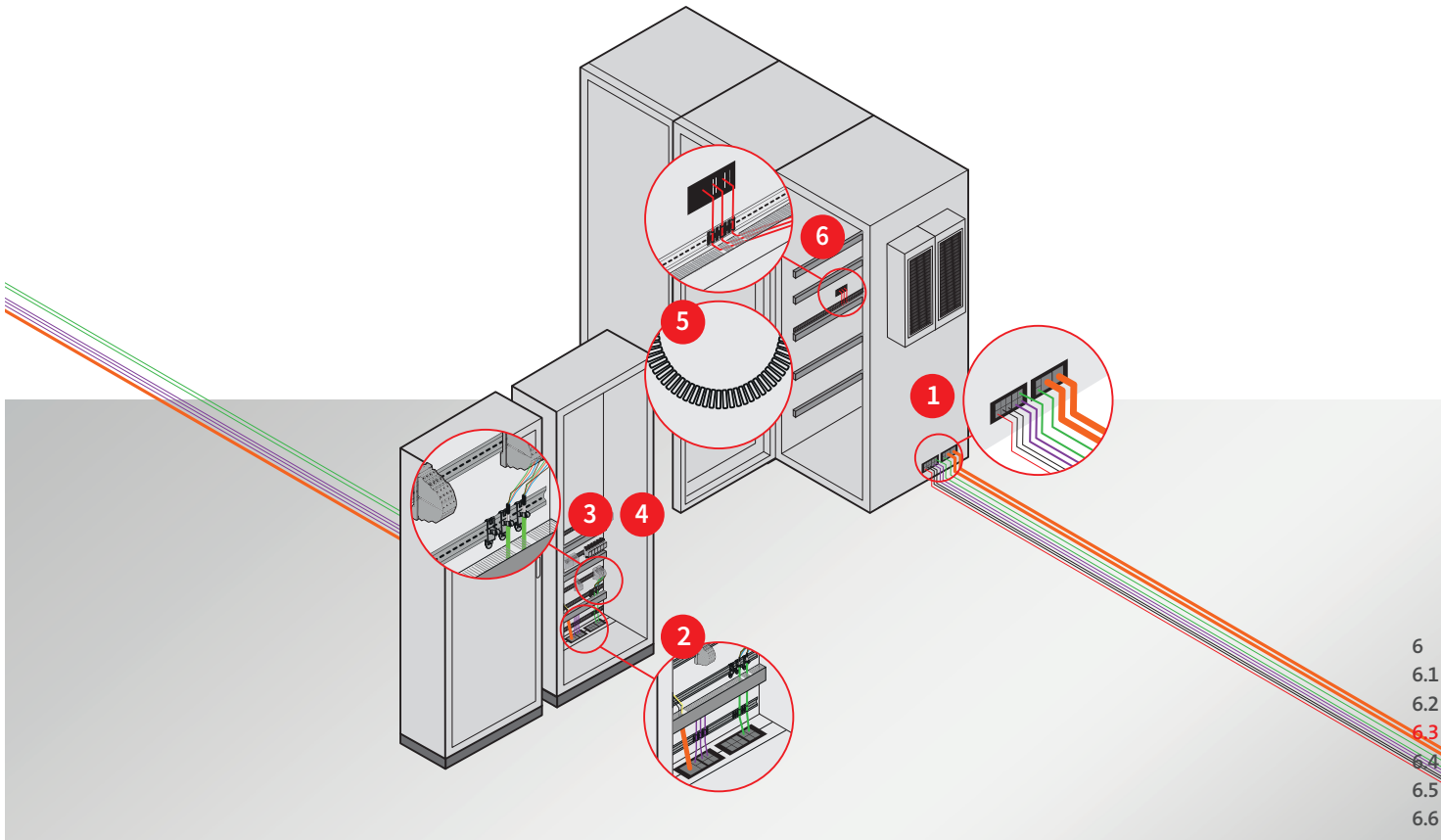

## 6.4 TE-M Thread extension for cable glands and cable entry plates

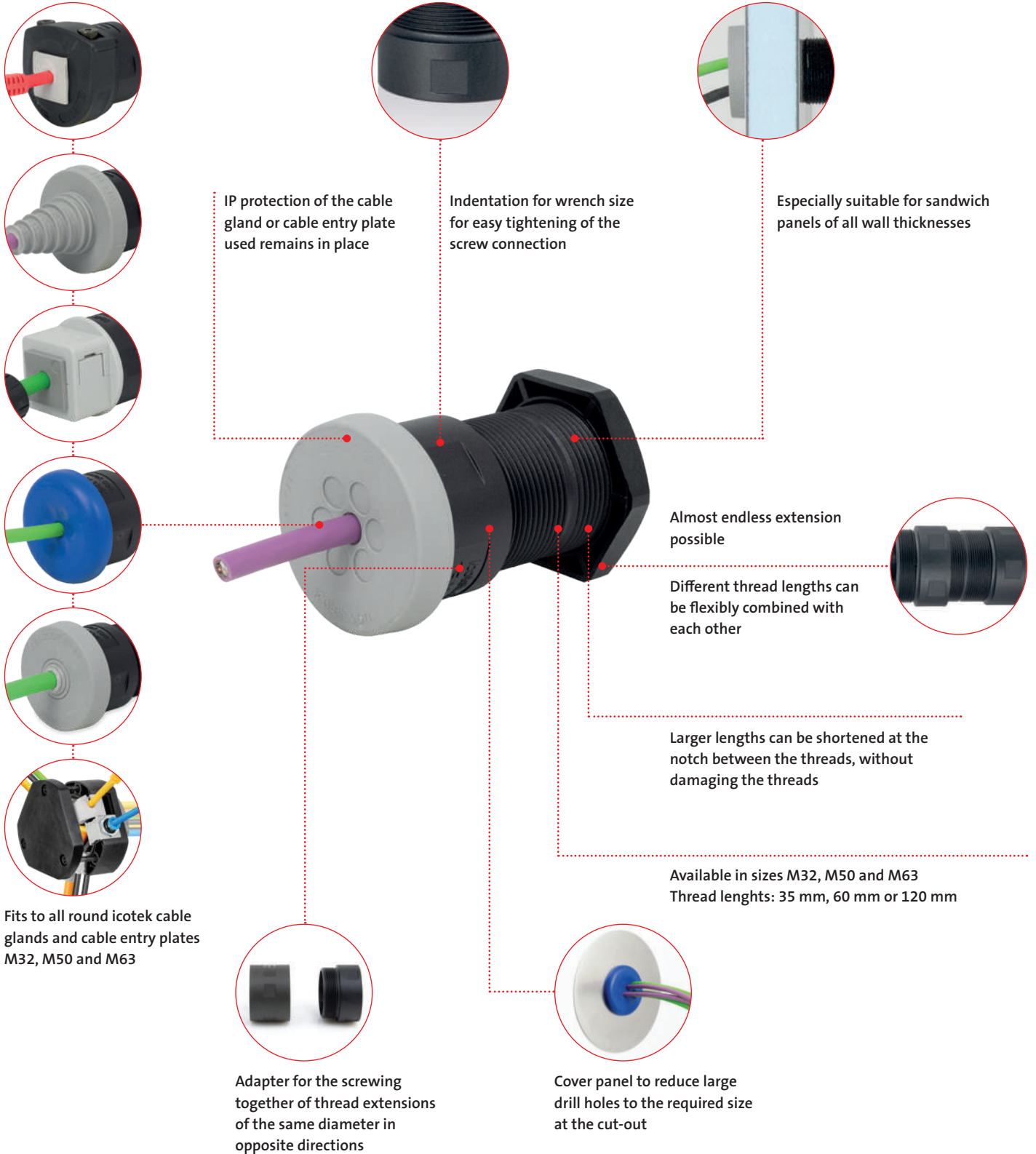

- 6
- 6.1
- 6.2
- 6.3
- 6.4**
- 6.5
- 6.6



**Thread extension**  
for cable glands and cable entry plates  
M32, M50, M63

TE-M

334 – 337

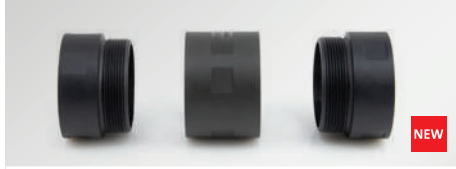

**Adapter**  
for thread extension  
M32, M50, M63

TE-MA

338



**Cover panel**  
for thread extension  
M32, M50, M63

AB-M

339



**Hexagonal Locknuts**  
M16 – M85

KGM / GM / GMT

346

## TE-M

### Thread extension for cable glands and cable entry plates

The icotek cable glands and cable entry plates with metric thread (pitch 1.5 mm) are screwed together with a locknut during assembly. If the thread lengths are not sufficient, for example when mounting on sandwich panels or thick concrete walls, icotek offers a practical solution: the icotek thread extension!

The icotek thread extension is available in three sizes (M32, M50, M63) and in three lengths (35 mm, 60 mm, 120 mm) and represents a real innovation in the field of cable management. The different lengths can be flexibly combined or shortened at the designated points. This means that not only very large, but also dimensionally accurate distances can be overcome when routing the cable. Due to their stable construction, almost any number of thread extensions can be screwed together. If the cable gland is not supplied with a locknut, this must be ordered as well.

#### Advantages

- Wide range of applications in different industries such as construction, building services, caravans, cleanroom and more
- Especially suitable for sandwich panels of all wall thicknesses
- IP protection of the cable gland or cable entry plate used remains in place
- Almost endless extension possible
- Different thread lengths can be flexibly combined with each other
- Larger lengths can be shortened at the notch between the threads, without damaging the threads
- Indentation for wrench size for easy tightening of the screw connection
- Available in sizes M32, M50 and M63
- Thread lengths: 35 mm, 60 mm or 120 mm
- Fits to all round icotek cable glands and cable entry plates M32, M50 and M63

#### Specifications

Material	Polyamide (PA)
Flame class	UL 94 V-0, self-extinguishing
Temperature	- 40°C to + 140°C (static)
Properties	Halogen free, silicone free
Cut-out sizes	37/55/68 mm (standard sizes for hole saws)

#### Accessories

TE-M	338
AB-M	339
KVT-ER	60-61
KVT	62-63
DB	70-71
KEL-DPZ	156-157
KEL-DPZ-HD	410-411
KEL-SCDP-TR	178-179
KEL-DPF	183
Locknut	346

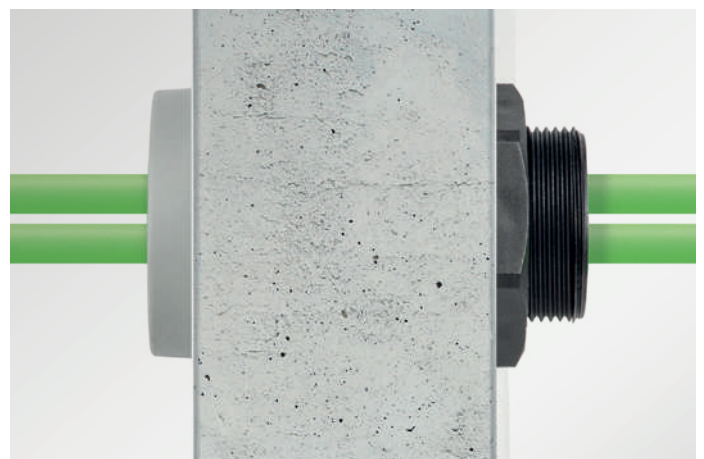



Type	Thread	Length	External diameter	Wrench size	Order No.	PU
TE-M32 35	M32 x 1,5	35 mm	36,5 mm	SW 35	52300	5
TE-M32 60	M32 x 1,5	60 mm	36,5 mm	SW 35	52301	5
TE-M32 120	M32 x 1,5	120 mm	36,5 mm	SW 35	52302	5
TE-M50 35	M50 x 1,5	35 mm	54,5 mm	SW 53	52310	5
TE-M50 60	M50 x 1,5	60 mm	54,5 mm	SW 53	52311	5
TE-M50 120	M50 x 1,5	120 mm	54,5 mm	SW 53	52312	5
TE-M 63 35	M63 x 1,5	35 mm	67,5 mm	SW 66	52313	5
TE-M 63 60	M63 x 1,5	60 mm	67,5 mm	SW 66	52314	5
TE-M 63 120	M63 x 1,5	120 mm	67,5 mm	SW 66	52315	5

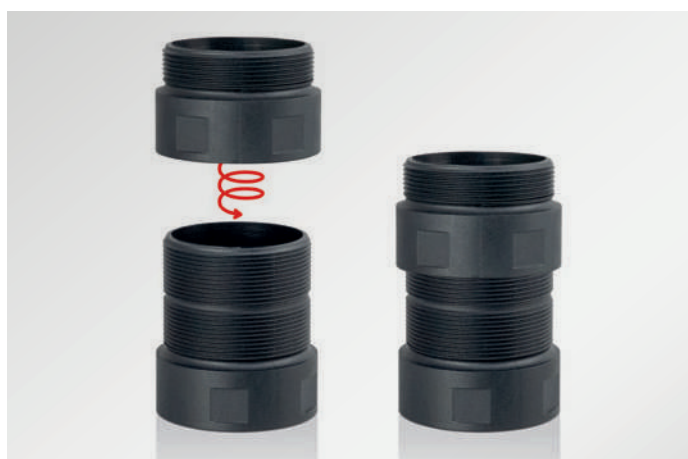

6  
6.1  
6.2  
6.3  
**6.4**  
6.5  
6.6

## Adapter for TE-M

The TE-MA adapter is available as a supplement to the thread extensions, which can be joined together in almost any order. This allows thread extensions of the same diameter to be screwed together in opposite directions so that a cable gland or cable entry can be fitted on both sides. This enables routing and sealing on both sides of the wall.

### Advantages

- Use of the thread extension on both sides
- IP protection of the cable gland and cable entry used remains intact
- Available in M32, M50 and M63
- Tool-free joining of two thread extensions

### Specifications

Material	Polyamide (PA)
Flame class	UL 94 V-0, self-extinguishing
Temperature	-40°C to +140°C (static)
Properties	Halogen free, silicone free

Type	Thread	Outer diameter	Length	Compatible with	Order No.	PU
Adapter TE-MA 32	32 x 1,5 mm	36,5 mm	38 mm	TE-M32	52305	5
Adapter TE-MA 50	50 x 1,5 mm	54,5 mm	38 mm	TE-M50	52307	5
Adapter TE-MA 63	63 x 1,5 mm	67,5 mm	38 mm	TE-M63	52308	5

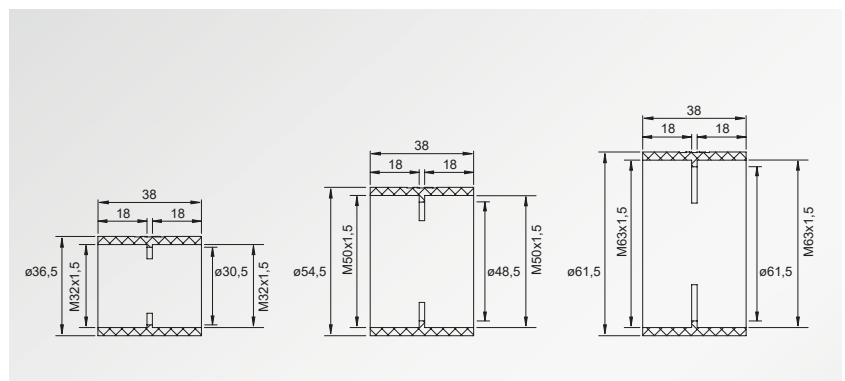
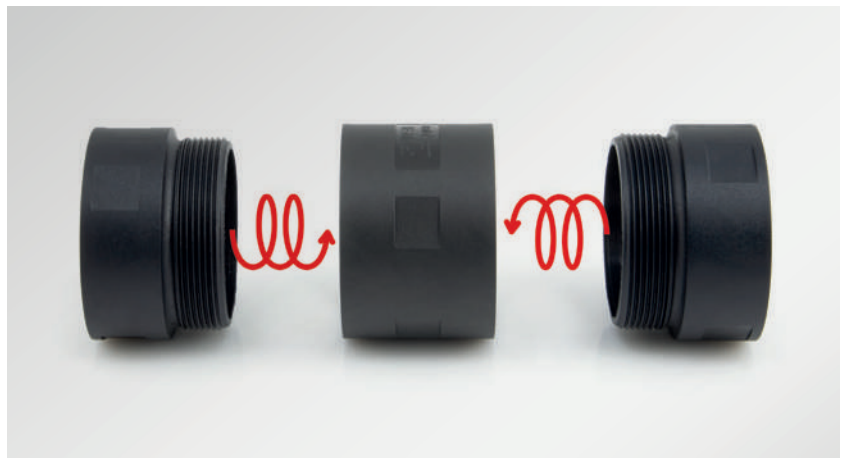

TE-MA 32

TE-MA 50

TE-MA 63

## Cover panel

Core drills with diameters from 80 mm are very often used to make wall openings in cleanrooms, cold storage rooms, buildings, etc. In order to be able to use the TE thread extension for such wall openings, the AB-M150 cover plates are used. They cover the large hole and reduce it to the required size. They also ensure a clean finish to the cut-out.

The cover panels have an outer diameter of 150 mm and a centre hole of 32.5 mm, 50.5 mm or 63.5 mm to accommodate the thread extension. They are made of 2 mm stainless steel and are bevelled on the outer radius to create a perfect transition to the wall.

### Advantages

- Reduction of large drill holes to the required size at the cut-out
- Suitable for the TE-M32, TE-M50 and TE-M63
- For a clean finish at the cut-out
- Perfect transition to the wall thanks to the bevel on the outer edge
- Installation with silicone or mounting adhesive (without fixing holes for hygiene reasons)

### Specifications

Material                   Stainless steel  
Material thickness    2 mm

Type	Inner diameter	Outer diameter	Material thickness	Compatible with	Order No.	PU
Cover panel AB-M 150-32	32,5 mm	150 mm	2 mm	TE-M32	52350	1
Cover panel AB-M 150-50	50,5 mm	150 mm	2 mm	TE-M50	52351	1
Cover panel AB-M 150-63	63,5 mm	150 mm	2 mm	TE-M63	52352	1

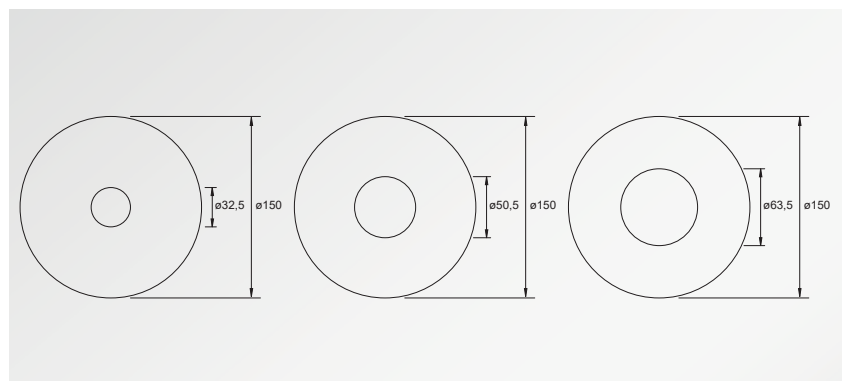
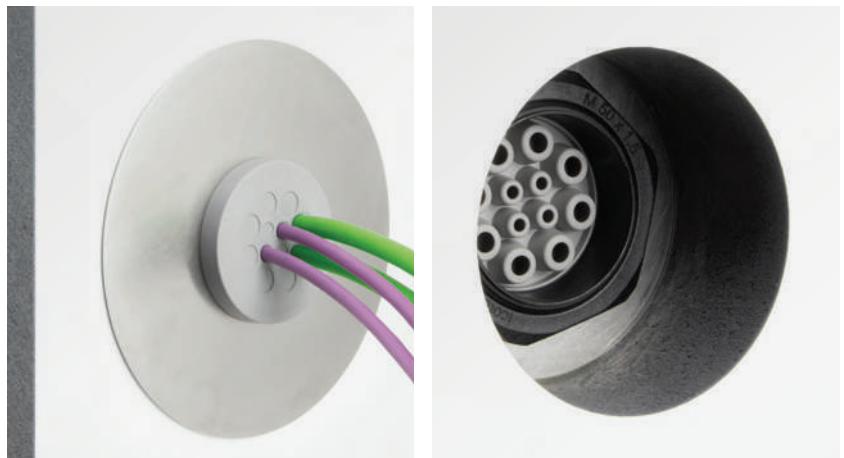

AB-M 150-32

AB-M 150-50

AB-M 150-63

## 6.5 KEA 90° Cable entry adapter

The 90° adapter  
for cable entries in size 24



**KEA 24 is a multifunctional adapter for various size 24 cable entry systems. Cables are routed through the adapter at a 90° angle.**

The installation direction can be horizontal or vertical. The cables are protected against mechanical tension in the entry and exit areas.

A major advantage of the new adapter is that a very high packing density can be achieved in combination with the icotek cable entry plates.



6  
6.1  
6.2  
6.3  
6.4  
6.5  
6.6



Quick and easy, partly tool-free (R variant) assembly



Easy snap-on assembly with KEL-DP 24 B (Variant R)



High packing density in combination with cable entry plates in size 24



High stability due to the geometry of the housing

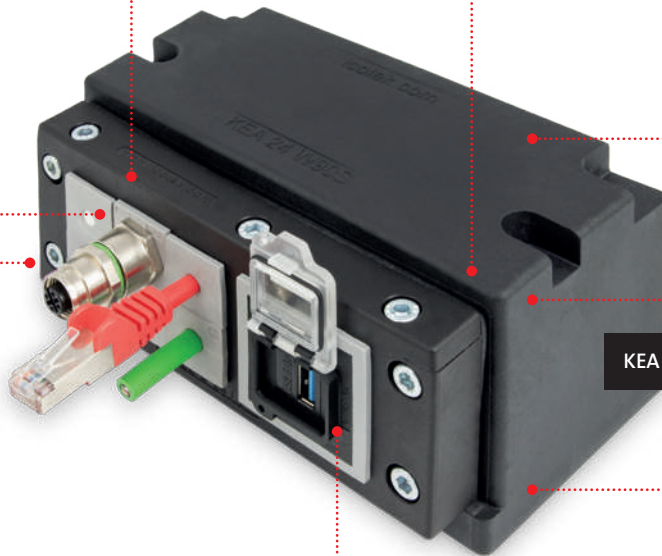

KEA 24 W90 S

Existing icotek products for cable entry can be used

Mechanical protection of the cables in the entry area

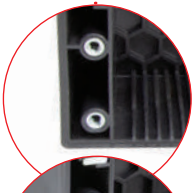

Wall mounting with threaded bushings or through bolts

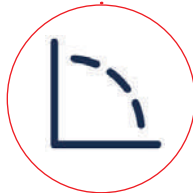

Cable entry 90° to the housing

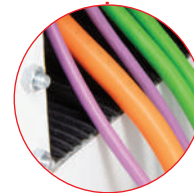

- 6
- 6.1
- 6.2
- 6.3
- 6.4
- 6.5
- 6.6

# KEA

## 90° Cable entry adapter

**NEW** up to **IP66**

KEA 24 is a cable entry adapter for accommodating various icotek cable entry frames and plates of size 24. The adapter allows cables to be routed at a 90° angle. The installation direction can be horizontal or vertical. The cables are protected against mechanical tension in the entry and exit areas. Wall mounting is done either with screws and nuts or by using threaded bushings. A flat rubber gasket is included in the shipment. icotek also offers suitable punches for the cut-out.

The cable entry plates KEL-DP 24 Type B can be easily snapped onto the KEA 24 W90 R. The cable entry frames KEL 24, KEL-U 24, KEL-ER 24, and the cable entry plates KEL-DPZ 24, KEL-DPR and KEL-DPU 24 can be screwed onto the KEA 24 W90 S. This enables the routing of cables with and without connectors.

Depending on the combination with an icotek cable entry system, the 90° adapter KEA achieves certified degrees of protection in accordance with EN 60529.

### Advantages

- Allows the adaptation of cable entry plates at a 90° angle
- Quick and easy, partly tool-free (R variant) assembly
- High packing density in combination with cable entry plates (size 24)
- Mechanical protection at cable entry and exit due to the closed housing
- Universal 90° adapter for many icotek products in size 24
- Space saving within the control cabinet due to the bending radius being shifted outwards
- Edge protection

### Specifications

Material	Polyamide (PA)
Colour	black (RAL 9005)
IP rating KEA + ...	KEL-ER 24: IP54, IP65 KEL-U 24: IP54 KEL 24: IP54 KEL-DPU 24: IP54, IP65 KEL-DPZ 24: IP54, IP65, IP66 KEL-DPR: IP54, IP65 KEL-DP 24 B: IP54
Flame class	UL 94 V-0, self-extinguishing
Temperature	- 40°C to + 120°C (static)
Properties	Halogen free, silicone free

### Compatible with

KEL(-U, -ER) 24	24, 17
KEL-DPU 24, KEL-DPZ 24, KEL-DPR, KEL-DP 24 B	145 - 150, 161, 163

### Accessories

Punches	378
---------	-----



Compatible punches page 378

# KEA

## 90° Cable entry adapter



Type	Cut-out KEA	Cut-out cable entry	compatible for	Colour	Order No.	PU
KEA 24 W90 R	112 x 56 mm	112 x 36 mm	KEL-DP 24 B	black	48300	1
KEA 24 W90 S	112 x 56 mm	112 x 36 mm	KEL-ER 24, KEL-U 24, KEL 24 KEL-DPU 24, KEL-DPR, KEL-DPZ 24	black	48301	1

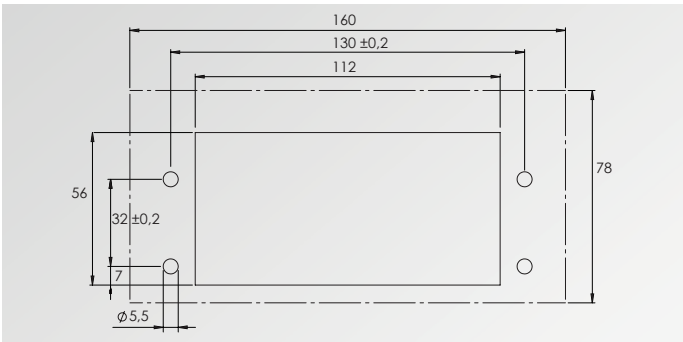

Cut-out and installation space KEA 24 W90 R and S

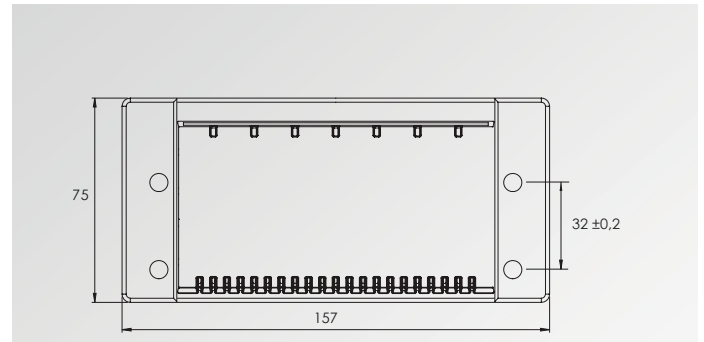

Rear side (wall side) KEA 24 W90 R and S

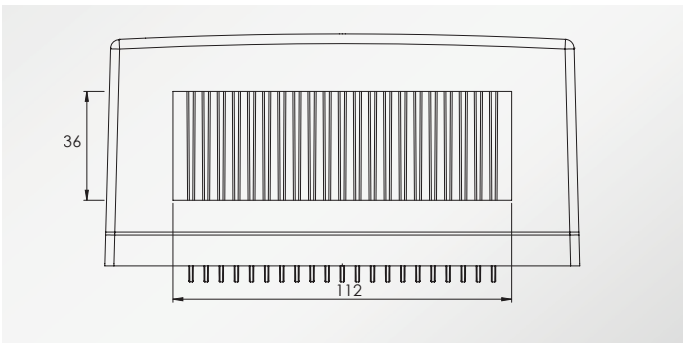

KEA 24 W90 R Cut-out for cable entry

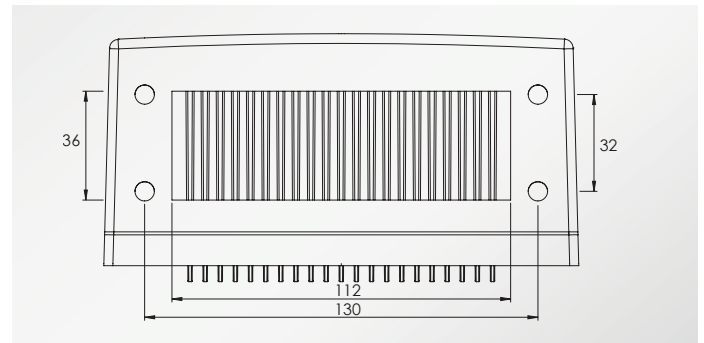

KEA 24 W90 S Cut-out for cable entry



KEA 24 W90 R



KEA 24 W90 S

- 6
- 6.1
- 6.2
- 6.3
- 6.4
- 6.5
- 6.6

## 6.6 Further accessories for enclosures

icotek offers useful enclosure accessories for easy assembly of cable entry components and EMC cable shield earthing products as well as for your cable management needs.



6  
6.1  
6.2  
6.3  
6.4  
6.5  
6.6





**Hexagonal Locknuts**  
M16 – M85

KGM / GM / GMT

346



**Supports**  
for top hat DIN rails and bus bars

MF

347



**Sealing bead**  
for enclosure base plates

348

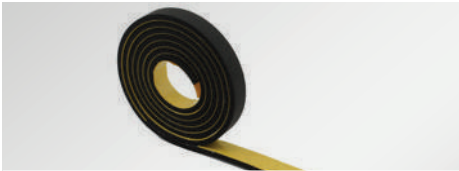

**Sealing tape**  
for enclosure base plates

348



**Drainage Device**

349



**Pressure compensation element**  
with metric thread

PCE M12 x 1,5

349



**Cable clamp**  
for C-rail mount

CCL

192 – 193



**Rittal / Hoffman / Others**  
Universal brush strip  
for enclosures

KDR-BES-U

356 – 363

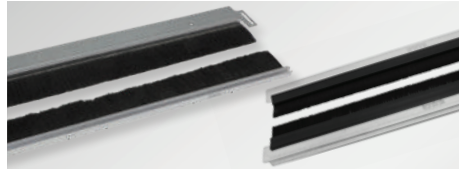

**Rittal**  
Enclosure gland plates  
with brush grommets

KDRS-BES-U / KDR-BES-TS8

357, 362 – 363



**Rittal**  
Split flange plates  
with brush strips

FP-AX-BES-U

366 – 367



**Brush strips for the cable management**  
in the server rack from various manufacturers

BES 10 / BES 19

368 – 369

6  
6.1  
6.2  
6.3  
6.4  
6.5  
6.6

Hexagon locknut with metric thread for assembly of components. For routing SUB-D, DVI or PROFIBUS connectors in combination with the split cable glands KVT/QVT, special locknuts with suitable cut-outs are required:

**KGM-SUB-D9** fits D-Sub 9 connectors  
(Required wall cut-out:  $\varnothing$  36 mm)

**KGM-PB** fits DVI and PROFIBUS connectors  
(Required wall cut-out:  $\varnothing$  42 mm)

**KGM-SUB-D25** fits SUB-D25 connectors  
(Required wall cut-out:  $\varnothing$  50 - 54 mm)

Split hexagon locknuts GMT for use in combination with split cable glands KVT/QVT whenever pre-terminated cables are routed inside cable protection conduits through a machine or cabinet wall. Suitable for split corrugated conduits CONFIX WST.

### Specifications

Material	Polyamide (PA)/Polycarbonate (PC)
Colour	<input type="checkbox"/> grey (similar RAL 7035) <input type="checkbox"/> black
Flame class	UL 94 V-0, self-extinguishing
Temperature	-30°C to +120°C
Properties	Halogen free, silicone free

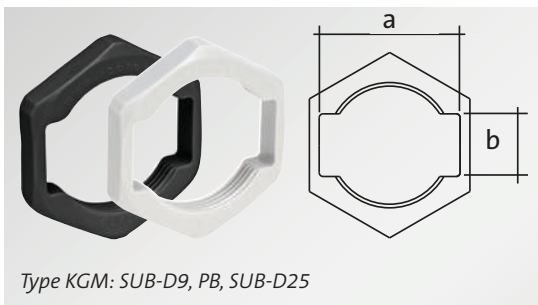

Thread	Type	Order No.	Material	Height [mm]	Wrench size	Diagonal [mm]	Cut-out a x b [mm]	PU
<b>Type KGM: Standard nut, plastic</b>								
M16 x 1.5	KGM 16	<input type="checkbox"/> 52272 <input type="checkbox"/> 52283	PA	4.3	SW 22.8	28.2	-	10
M20 x 1.5	KGM 20	<input type="checkbox"/> 52273 <input type="checkbox"/> 52283	PA	7	SW 26	28.2	-	10
M25 x 1.5	KGM 25	<input type="checkbox"/> 52274 <input type="checkbox"/> 52284	PA	7	SW 32	36	-	10
M32 x 1.5	KGM 32	<input type="checkbox"/> 52275 <input type="checkbox"/> 52285	PA	7	SW 41	46	-	10
M40 x 1.5	KGM 40	<input type="checkbox"/> 52276 <input type="checkbox"/> 52286	PA	7	SW 50	56	-	10
M50 x 1.5	KGM 50	<input type="checkbox"/> 52277 <input type="checkbox"/> 52287	PA	8.5	SW 60	66	-	10
M63 x 1.5	KGM 63	<input type="checkbox"/> 52278 <input type="checkbox"/> 52288	PA	8.5	SW 75	83	-	5
M75 x 1.5	KGM 75	<input type="checkbox"/> 52289	PA	8.5	SW 85	93.1	-	5
M85 x 2	KGM 85	<input type="checkbox"/> 52290	PA	10	SW 100	109.5	-	5
<b>Type KGM: PB, SUB-D9, SUB-D25</b>								
M32 x 1.5	KGM-SUB-D9	<input type="checkbox"/> 45105 <input type="checkbox"/> 45106	PC	7	SW 41	46	35 x 16	10
M40 x 1.5	KGM-PB	<input type="checkbox"/> 45107 <input type="checkbox"/> 45109	PC	8	SW 50	55	43 x 17	10
M50 x 1.5	KGM-SUB-D25	<input type="checkbox"/> 45108 <input type="checkbox"/> 45110	PC	8	SW 60	66	55 x 16	10
<b>Type GMT: Split locknut</b>								
M16 x 1.5	GMT 16	<input type="checkbox"/> 31105	PA	8	SW 19	21	-	10
M20 x 1.5	GMT 20	<input type="checkbox"/> 31110	PA	9	SW 27	29	-	10
M25 x 1.5	GMT 25	<input type="checkbox"/> 31100	PA	9	SW 32	35	-	10
M32 x 1.5	GMT 32	<input type="checkbox"/> 31120	PA	12	SW 40	44	-	10
M40 x 1.5	GMT 40	<input type="checkbox"/> 31130	PA	15	SW 48	53	-	10
M50 x 1.5	GMT 50	<input type="checkbox"/> 31140	PA	15	SW 63	69	-	10

# MF

## Supports for top hat DIN rails and bus bars

There are 4 models of supports for mounting bus bars 10 × 3 mm or 35 mm top hat DIN rails. Various supports are available to provide solutions for different conditions.

A mounting clip is used for fastening the bus bar to the supports. The support has M6 female screw threads to affix the mounting clip of the DIN rail with a M6 screw.

### Advantages & benefits

- Wide variety of supports with different sizes and designs
- Simple assembly of top hat DIN rails and 10 × 3 mm bus bars
- Support type D provides possibility to affix 2 top hat DIN rails

### Specifications



Material Sheet steel, galvanically zinc-plated

### Accessories

Bus bar Order No. 36100

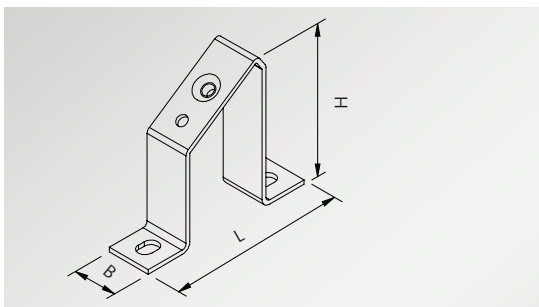
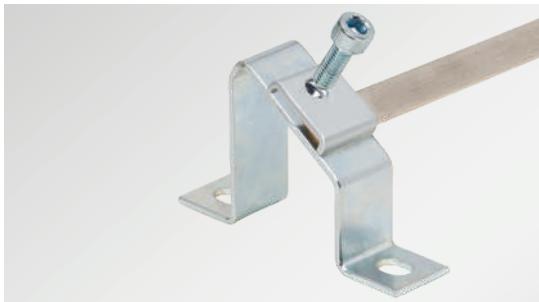
Mounting clip Order No. 36150



Description	Type	Version	Order No. without Clip	Order No. with Clip	Dimension [L × B × H]	PU
Type A	MF-A49	Type A	36056	36058	80 × 20 × 49 mm	10
	MF-A68	Type A	36064	36066	80 × 20 × 68 mm	10
	MF-A88	Type A	36072	36074	80 × 20 × 88 mm	10
Type B	MF-B20	Type B	36000	36002	80 × 20 × 20 mm	10
	MF-B30	Type B	36008	36010	80 × 20 × 30 mm	10
	MF-B50	Type B	36016	36018	80 × 20 × 50 mm	10
	MF-B90	Type B	36024	36026	80 × 20 × 90 mm	10
Type C	MF-C40	Type C	36032	36034	40 × 18 × 40 mm	10
	MF-C53	Type C	36040	36042	40 × 18 × 53 mm	10
	MF-D49	Type D	36048	36050	120 × 20 × 49 mm	10

### Bus bar 10 × 3 mm

Type	Order No.	PU	
Bus bar 10 × 3 mm	10 × 3 × 1000 mm*	36100	1

\* Other lengths available on request

## Sealing bead

### Self-adhesive foamed PU seal

The KDR-BMP enclosure base plates have a foamed PU seal glued to the underside. icotek now also offers this separately for individual applications.

The PU seal is applied to a self-adhesive carrier film and is available in 2 widths. The length is 2150 mm in each case. The height of the seal is determined by the respective width. The PU seal is easy to compress and has very good recovery properties.

#### Advantages & benefits

- Very simple and quick installation
- Easy laying around corners
- Very good recovery properties

#### Specifications

Material	PU foam
Temperature	-40°C to 80°C
Properties	halogen free, silicone free

Type	Length	Width	Height	Order No.	PU
Sealing bead	2150 mm	6 mm	3.5 mm	43347	1
Sealing bead	2150 mm	9 mm	5 mm	43348	1



*Installing the PUR seal is very easy: remove the protective film, stick it on, done!*

## Sealing tape

icotek offers a one-sided self-adhesive sealing tape for the enclosure base plates. It is available in two lengths, 1 metre and 10 metres long.

#### Advantages & Benefits

- Very simple and quick installation
- Very good recovery properties

#### Specifications

Material	Cellular rubber (CR/NBR)
Temperature	-40°C to +100°C
Flame class	UL 94-HF1

Type	Length	Width	Height	Order No.	PU
Sealing tape	1 m	10 mm	3 mm	42999	1
Sealing tape	10 m	10 mm	3 mm	42999.10000	1

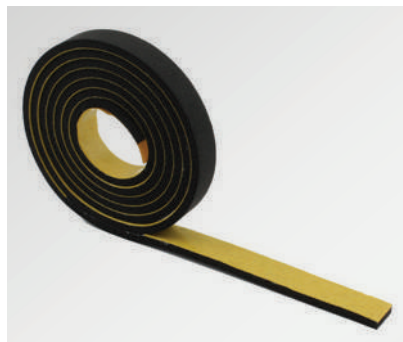

Sealing tape  
Order No. 42999 (L: 1 m)  
Order No. 42999.10000 (L: 10 m)

# Drainage device Pressure compensation element

IP69K IP67 IP66 Made in Germany RoHS compliant

## Drainage device

In enclosures and housings with a high degree of protection, temperature differences result in condensation. By using a drainage device, it is possible to safely drain off the condensate without losing a maximum enclosure protection of IP66. A water-permeable membrane ensures the drainage of the enclosure due to its capillary effect. The design prevents splash water from entering the interior of the enclosure.

### Advantages & benefits

- High protection class IP66/67, IP69K
- Good drainage performance
- Easy assembly
- Based on a standard cut-out
- Sturdy, weatherproof and UV-resistant housing

### Specifications

Water entry level	0 mm (at 0.5 mm wall thickness)
Gasket	Sealing gasket NBR
Water permeability	approx. 200 ml/h with a water column of 5 mm
Mounting position	horizontal, lowest point
Temperature	-45 to +70°C

Type	Dimension Ø	Cut-out Ø	Order No.	PU
Drainage Device for M50 hole	60 mm	50 mm	99193	1

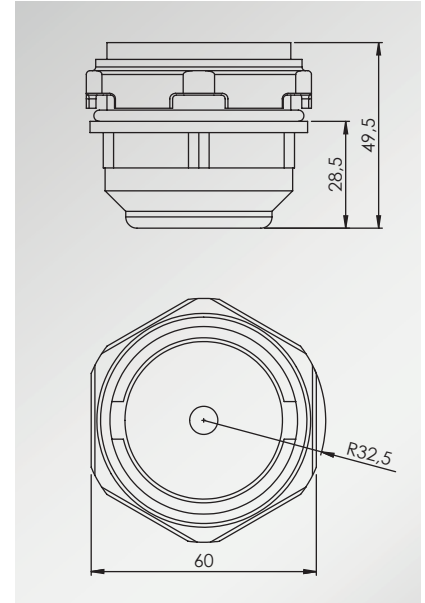

## Assembly

The drainage device is fixed in the bottom of the enclosure using the union nut in a hole of  $\varnothing 50.5 \pm 0.5$  mm. Make sure that the sealing ring is on the outer housing wall and that the hole is free of burrs.

## Pressure compensation element with metric thread

The pressure compensation element PCE with M12 x 1.5 thread is used to avoid variations in pressure caused by differences in temperature and thus to prevent damage caused by condensation. It provides protection class IP68. The pressure compensation element is easy to install by screwing it directly into the enclosure wall or via adapter grommets AT-K-M 12x1.5.

### Specifications

Material	Polyamide
Flame class	UL 94 V-2
Protection class	IP67, IP68
Temperature	-20°C to +100°C

Type	Order No.	Thread	PU
PCE M12 x 1.5	99190	M12 x 1.5	10



KVT-ER 63|4 equipped with pressure compensation element

6  
6.1  
6.2  
6.3  
6.4  
6.5  
6.6



RoHS  
compliant

Made in  
Germany

# Cable pass-through with brush seal

Brush plates and brush strips for enclosures, server racks, machines



## 7 Cable pass-through with brush seal

### Brush plates and brush strips for enclosures, server racks, machines

**icotek offers cable pass-through solutions with brush seals that are perfectly suitable for applications where no high sealing rate is required. The icotek brush seal solutions are meant for dust and dirt-proof cable pass-through of cables with and without preassembled connectors.**

The application areas for a cable pass-through with brush seal are very versatile, e.g. in an electrical enclosure, a server rack, on a machine wall or on raised floors. icotek brush plates and brush strips are a cost-effective solution for a professional cable management.

The brush seal solutions allow reduced airflow while filtering out dust and larger particles. Thermal protection and visual screening are additional benefits. icotek brush plates also protect cables against wear due to sharp edges of the cut-out.

For cable pass-through applications in base areas of enclosures and server racks by numerous manufacturers and for wide cut-outs on machine walls icotek offers the universal brush strip KDR-BES-U. Due to the innovative clamp profile the brush strip can be clamped on any sheet metal edge, even in a 90° angle.

The 2-piece enclosure gland plates KDR-BES and flange plates FP-AX-BES are pre-equipped with brush strips and serve as dust- and dirt-tight cable pass-through.



Quick and easy assembly,  
partly without tools

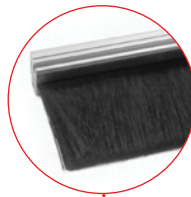

Customization possible



Round versions for screw-in  
or snap-in assembly



For metric or standard  
cut-outs



Screw mounting or  
mounting via expanding  
rivets possible

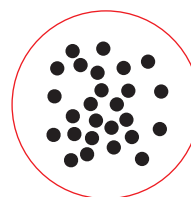

Protection against  
dust

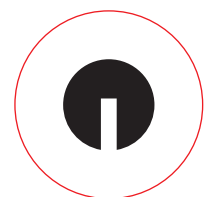

Protection against  
wear due to sharp  
edges of the cut-out



## Brush plate for cable pass-through



**Brush plate**  
for cable pass-through  
for standard cut-outs

KEL-BES

354



**Split brush plate**  
for cable pass-through  
for standard cut-outs

KEL-BES-S

355



**Thread extension**  
for cable glands and  
cable entry plates  
M32, M50, M63

TE-M

334 – 337

## Brush strips, gland plates and flange plates with brush strips



**Universal brush strip**  
for enclosures (Rittal/Hoffman/Others)

KDR-BES-U / KDR-BES-U-... series

356 – 363

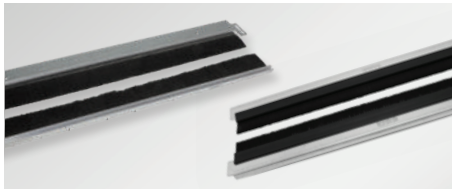

**Rittal  
Enclosure gland plates**  
with brush grommets

KDRS-BES-U / KDR-BES-TS8

362 – 363

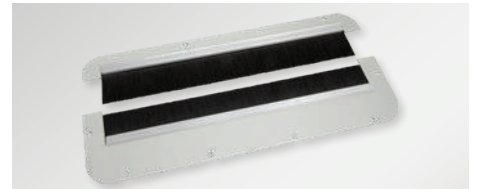

**Rittal  
Split flange plates**  
with brush strips

FP-AX-BES-U

366 – 367

## Brush strips for the cable management in the 10" and 19" server rack



**Brush strips for the cable management**  
in the 10" server rack from various  
manufacturers

BES 10

368 – 369



**Brush strips for the cable management**  
in the 19" server rack from various  
manufacturers

BES 19

368 – 369

# KEL-BES

## Brush plate for cable pass-through



Brush plates KEL-BES for routing cables into server racks, control panels and electrical enclosures. KEL-BES is also an ideal solution for entry and exit of cables that are routed inside raised floors, e.g. in datacentres or IT closets. The brush plates can either be mounted via screws or via expanding rivets.

The KEL-BES plates match exactly the cut-out dimensions for 10-, 16- or 24-pin standard industrial connectors.

### Advantages & benefits

- Fast and easy assembly (optional: snap in assembly)
- Versatile utilisation
- Filtering out dust, hair and larger particulate matter
- Visual screening
- Protects cables against wear due to sharp edges of the cut-out
- For industrial standard cut-outs

### Specifications

Material	Frame, rectangular: Polyamide (PA) (Flame class UL 94 V-0) Brushes: Polyamide (PA) Brush profile: sheet steel, zinc plated
Temperature	-20°C to +90°C
Properties	Halogen-free, silicone-free
Frame depth	10 mm

### Accessories

KEL-EMC-PF Cable collectors	261
-----------------------------	-----

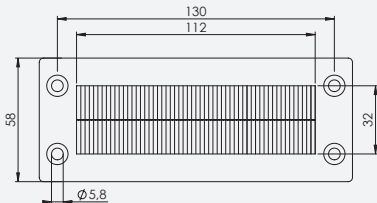
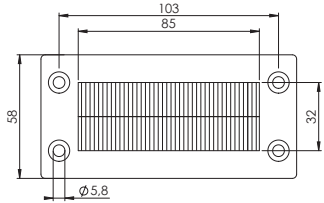
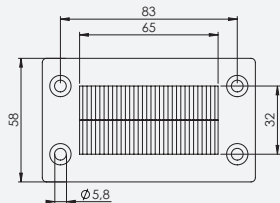
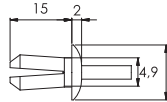
Description	Type	Order No.	Cut-out	PU
	KEL-BES 24	51515	36 x 112 mm	10
	KEL-BES 16	51510	36 x 86 mm	10
	KEL-BES 10	51505	36 x 65 mm	10
	Expanding rivets	99153	For wall thickness 1 – 4 mm	100

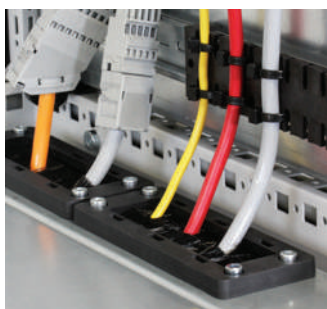

Suitable for control panel construction



... as well as for energy and building technology



Screw mounting or mounting via expanding rivets possible



Round version with M50 thread for locknut or snap-in mounting

# KEL-BES-S

## Split brush plate for cable pass-through



Split brush plates KEL-BES-S for routing cables into server racks, control panels and electrical enclosures. The brush plates can either be mounted via screws or via expanding rivets. Due to the split frame the KEL-BES-S can also be subsequently installed around the routed cables. The KEL-BES-S frames match exactly the cut-out dimensions for 10-, 16- or 24-pin standard industrial connectors.

For round metric cut-outs M32/M50 icotek offers the split KEL-BES-S 32/50. It can be either directly snapped into the cut-out or screwed with a locknut (included in the shipment).

### Advantages & benefits

- Fast and easy assembly (optional: snap in assembly)
- Subsequent assembly possible
- Versatile utilisation
- Filtering out dust, hair and larger particulate matter
- Visual screening
- Protects cables against wear due to sharp edges of the cut-out
- For industrial standard cut-outs

### Specifications

Material	Frame, rectangular: Polyamide (PA) Frame, round: Polycarbonate (PC) (Flame class UL94-Vo) Brushes: Polyamide (PA) Brush profile: sheet steel, zinc plated
Temperature	- 20°C to + 90°C
Properties	Halogen-free, silicone-free
Frame depth	10 mm

### Accessories

KEL-EMC-PF Cable collectors	261
TE-M	334-337

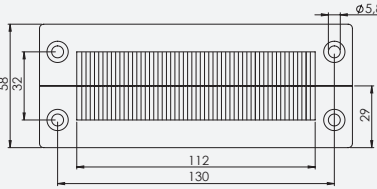
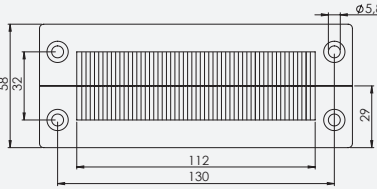
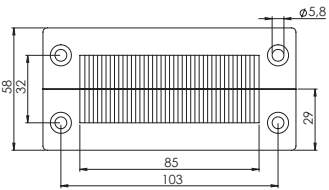
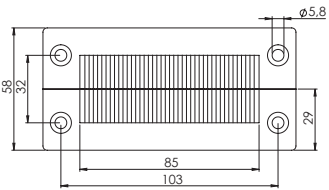
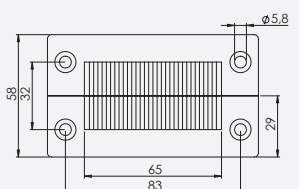
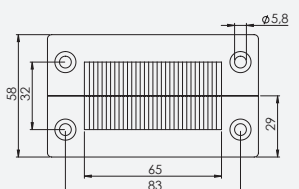
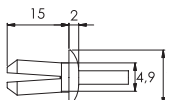
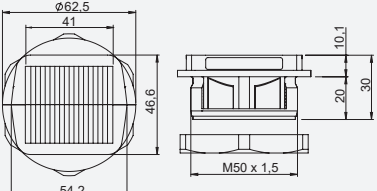
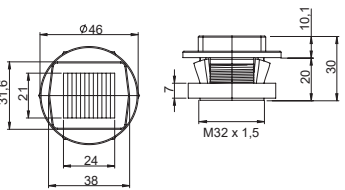

Description	Type	Order No.	Cut-out	PU
	KEL-BES-S 24	51522	36 x 112 mm	10
	KEL-BES-S 24 with expanding rivets	51522.002	36 x 112 mm	10
	KEL-BES-S 16	51521	36 x 86 mm	10
	KEL-BES-S 16 with expanding rivets	51521.002	36 x 86 mm	10
	KEL-BES-S 10	51520	36 x 65 mm	10
	KEL-BES-S 10 with expanding rivets	51520.002	36 x 65 mm	10
	Expanding rivets	99153	For wall thickness 1–4 mm	100
	KEL-BES-S 50	51540	M50 x 1.5 Snap-in function for wall thickness 1–2.5 mm	10
	KEL-BES-S 32	51538	M32 x 1.5 Snap-in function for wall thickness 1–2.5 mm	10

# KDR-BES-U

## Universal brush strip for enclosures



Cable pass-through brush strip for enclosure bases or individual cut-outs on cabinets, enclosures, panels, server racks or machine walls. Due to the innovative and universal clamp strip the brush can also be assembled in a 90° angle, e.g. on bent sheet metal. Suitable for wall thickness 1.5 - 2 mm or 2.5 - 3 mm. Brush may be removed from the profile at any time and remounted using other mounting options.

The KDR-BES-U brush strip is adaptable to almost any enclosure or cabinet type on the market. The standard gland plates included in the enclosure delivery can be used for assembly. They do not have to be changed.

### Advantages & benefits

- Fast, simple and tool-free mounting
- Original enclosure gland plates can be used
- Three mounting types possible
- Brush may be remounted at any time using other mounting options
- Available in any custom length up to 1.500 mm

### Specifications

Material clamp strip	Aluminium
Material backing strips	Metal, galvanised
Material bristles	Polyamide (PA)
For sheet thickness	1.5 – 2 mm, 2.5 – 3 mm
Temperature	-20°C to +90°C
Properties	Halogen free, silicone free

## Brush strips in your required length (up to 1.500 mm)

X (mm) = sight size of base opening  
X max. = 1500 mm

### Order numbers examples:

For sheet thickness 1.5 – 2 mm, trim height 35 mm:  
X = 999 mm → Order No. 58210.0999

For sheet thickness 2.5 – 3 mm, trim height 35 mm:  
X = 999 mm → Order No. 58225.0999

For sheet thickness 1.5 – 2 mm, trim height 50 mm:  
X = 999 mm → Order No. 58215.0999

For sheet thickness 2.5 – 3 mm, trim height 50 mm:  
X = 999 mm → Order No. 58230.0999

### Scope of delivery:

1× KDR-BES-U (clamp strip + brush)

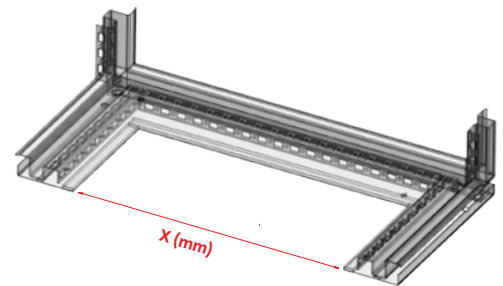

## KDR-BES-U mounting options

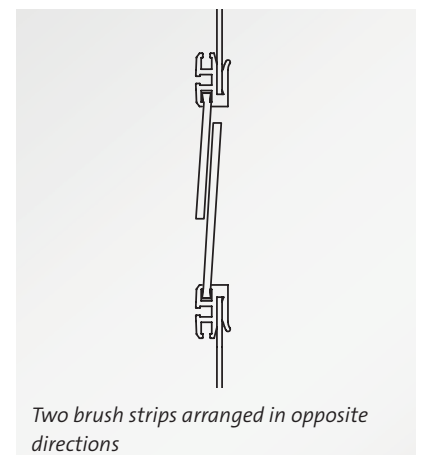
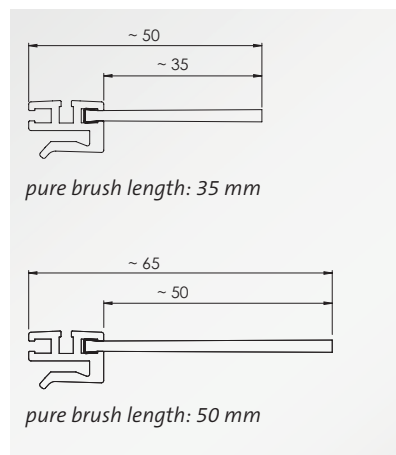
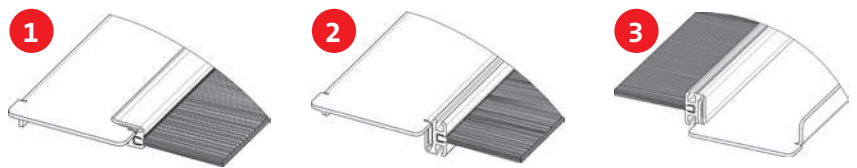

# KDR-BES-U

## Brush strip for gland plates Rittal VX25/TS8 & Hoffman PROLINE G2



Type	Enclosure type	Enclosure width	Brush strip length	Trim height	Order no.	PU
<b>KDR-BES-U for Rittal VX25 enclosures</b>						
KDR-BES-U-VX25-600	Rittal VX25	600 mm	452 mm	35 mm	58225.0452	1
KDR-BES-U-VX25-800	Rittal VX25	800 mm	652 mm	35 mm	58225.0652	1
KDR-BES-U-VX25-1000	Rittal VX25	1000 mm* with division bar	402 mm	35 mm	58225.0402	1
KDR-BES-U-VX25-1200	Rittal VX25	1200 mm* with division bar	502 mm	35 mm	58225.0502	1
KDR-BES-U-VX25-600	Rittal VX25	600 mm	452 mm	50 mm	58230.0452	1
KDR-BES-U-VX25-800	Rittal VX25	800 mm	652 mm	50 mm	58230.0652	1
KDR-BES-U-VX25-1000	Rittal VX25	1000 mm* with division bar	402 mm	50 mm	58230.0402	1
KDR-BES-U-VX25-1200	Rittal VX25	1200 mm* with division bar	502 mm	50 mm	58230.0502	1
<b>KDR-BES-U for Rittal TS8 enclosures</b>						
KDR-BES-U-TS8-600	Rittal TS8	600 mm	435 mm	35 mm	58210.0435	1
KDR-BES-U-TS8-800	Rittal TS8	800 mm	635 mm	35 mm	58210.0635	1
KDR-BES-U-TS8-1000	Rittal TS8	1000 mm* with division bar	397 mm	35 mm	58210.0397	1
KDR-BES-U-TS8-1000	Rittal TS8	1000 mm without division bar	835 mm	35 mm	58210.0835	1
KDR-BES-U-TS8-1200	Rittal TS8	1200 mm* with division bar	495 mm	35 mm	58210.0495	1
<b>KDR-BES-U for Hoffman PROLINE G2 enclosures</b>						
KDR-BES-U-HG2-600	Hoffman PROLINE G2	600 mm / 1200 mm*	362 mm	35 mm	58210.0362	1
KDR-BES-U-HG2-800	Hoffman PROLINE G2	800 mm	562 mm	35 mm	58210.0562	1
KDR-BES-U-HG2-1000	Hoffman PROLINE G2	1000 mm	762 mm	35 mm	58210.0762	1
Edge protection trim	universal	Clamping range 1-2 mm			99152	100 m



Edge protection trim (100 m)  
Order No. 99152

\* in case both fields of the enclosure are equipped, 2 brush strips KDR-BES-U are necessary.

# KDR-BES-U

## Brush strip for Häwa enclosures



Type	Enclosure type	Enclosure width	Brush strip length	Trim height	Order no.	PU
KDR-BES-U for Häwa enclosures series H395 and series H390						
KDR-BES-U HW-600	Häwa	600 mm	392 mm	35 mm	58210.0392	1
KDR-BES-U HW-800	Häwa	800 mm	592 mm	35 mm	58210.0592	1
KDR-BES-U HW-1000	Häwa	1000 mm	792 mm	35 mm	58210.0792	1
KDR-BES-U HW-1200	Häwa	1200 mm	992 mm	35 mm	58210.0992	1
KDR-BES-U HW-600	Häwa	600 mm	392 mm	50 mm	58215.0392	1
KDR-BES-U HW-800	Häwa	800 mm	592 mm	50 mm	58215.0592	1
KDR-BES-U HW-1000	Häwa	1000 mm	792 mm	50 mm	58215.0792	1
KDR-BES-U HW-1200	Häwa	1200 mm	992 mm	50 mm	58215.0992	1

These brush strips KDR-BES-U are suitable for Häwa enclosures series H395 and series H390.

**i** icotek also produces brush strips for numerous other enclosure brands and in other sizes according to your wishes. Ask us at [pm@icotek.com](mailto:pm@icotek.com)!

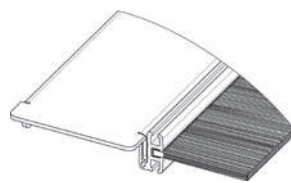
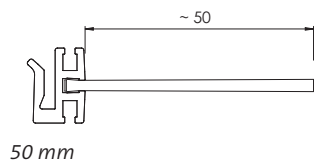
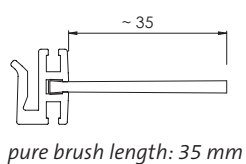

Mounting option Häwa



# KDR-BES-U

## Brush strip for Schneider Electric enclosures



Type	Enclosure type	Enclosure width	Brush strip length	Trim height	Order no.	PU
KDR-BES-U for Schneider Electric enclosures series Spacial SF						
KDR-BES-U SSP-600	Schneider Electric	600 mm	414 mm	35 mm	58210.0414	1
KDR-BES-U SSP-800	Schneider Electric	800 mm	614 mm	35 mm	58210.0614	1
KDR-BES-U SSP-1000	Schneider Electric	1000 mm	814 mm	35 mm	58210.0814	1
KDR-BES-U SSP-1200	Schneider Electric	1200 mm *	477 mm	35 mm	58210.0477	1
KDR-BES-U SSP-600	Schneider Electric	600 mm	414 mm	50 mm	58215.0414	1
KDR-BES-U SSP-800	Schneider Electric	800 mm	614 mm	50 mm	58215.0614	1
KDR-BES-U SSP-1000	Schneider Electric	1000 mm	814 mm	50 mm	58215.0814	1
KDR-BES-U SSP-1200	Schneider Electric	1200 mm *	477 mm	50 mm	58215.0477	1

These brush strips KDR-BES-U are suitable for Schneider Electric enclosures series Spacial SF.

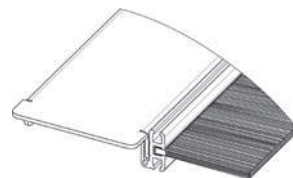
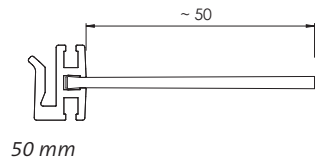
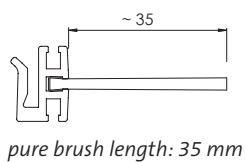

Mounting option  
Schneider Electric



\* in case both fields of the enclosure are equipped, 2 brush strips KDR-BES-U are necessary.

# KDR-BES-U

## Brush strip for ELDON enclosures



Type	Enclosure type	Enclosure width	Brush strip length	Trim height	Order no.	PU
KDR-BES-U for ELDON/nVent enclosures type MCD, MCS, MKS und MKD						
KDR-BES-U Eldon 600	ELDON/nVent	600 mm	435 mm	35 mm	58221.0435	1
KDR-BES-U Eldon 800 + 1600	ELDON/nVent	800 mm 1600 mm *	635 mm	35 mm	58221.0635	1
KDR-BES-U Eldon 1000	ELDON/nVent	1000 mm	835 mm	35 mm	58221.0835	1
KDR-BES-U Eldon 1200	ELDON/nVent	1200 mm *	495 mm	35 mm	58221.0495	1
KDR-BES-U Eldon 600	ELDON/nVent	600 mm	435 mm	50 mm	58222.0435	1
KDR-BES-U Eldon 800 + 1600	ELDON/nVent	800 mm 1600 mm *	635 mm	50 mm	58222.0635	1
KDR-BES-U Eldon 1000	ELDON/nVent	1000 mm	835 mm	50 mm	58222.0835	1
KDR-BES-U Eldon 1200	ELDON/nVent	1200 mm *	495 mm	50 mm	58222.0495	1

These brush strips KDR-BES-U are suitable for ELDON/nVent enclosures type MCD, MCS, MKS und MKD.



icotek also produces brush strips for numerous other enclosure brands and in other sizes according to your wishes. Ask us at [pm@icotek.com](mailto:pm@icotek.com)!

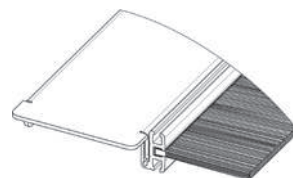
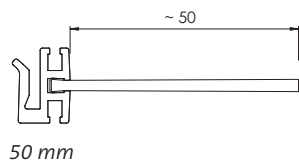
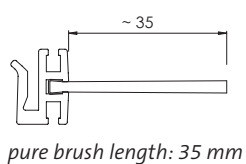

Mounting option ELDON





# KDR-BES-U

## Brush strip for ETA enclosures



Type	Enclosure type	Enclosure width	Brush strip length	Trim height	Order no.	PU
<b>KDR-BES-U for ETA enclosures type E NUX</b>						
KDR-BES-U 600 ETA E NUX	ETA	600 mm	363 mm	35 mm	58221.0363	1
KDR-BES-U 800 ETA E NUX	ETA	800 mm	563 mm	35 mm	58221.0563	1
KDR-BES-U 1000 ETA E NUX	ETA	1000 mm *	345 mm	35 mm	58221.0345	1
KDR-BES-U 1200 ETA E NUX	ETA	1200 mm *	445 mm	35 mm	58221.0445	1
KDR-BES-U 600 ETA E NUX	ETA	600 mm	363 mm	50 mm	58222.0363	1
KDR-BES-U 800 ETA E NUX	ETA	800 mm	563 mm	50 mm	58222.0563	1
KDR-BES-U 1000 ETA E NUX	ETA	1000 mm *	345 mm	50 mm	58222.0345	1
KDR-BES-U 1200 ETA E NUX	ETA	1200 mm *	445 mm	50 mm	58222.0445	1

These brush strips KDR-BES-U are suitable for ETA enclosures type E NUX.

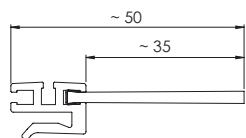

pure brush length: 35 mm

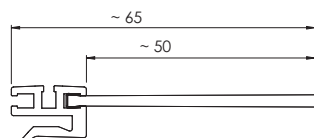

50 mm

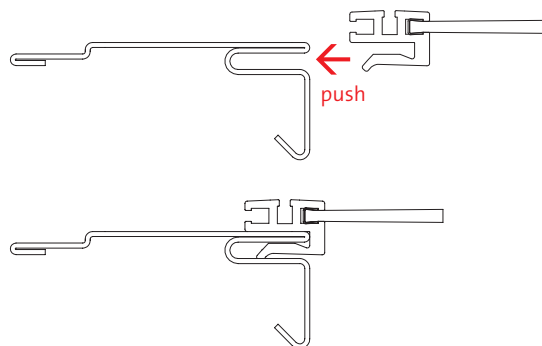
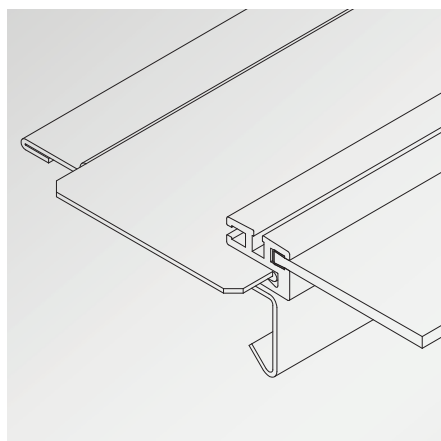

Assembly ETA

7  
7.1  
7.2  
7.3

\* in case both fields of the enclosure are equipped, 2 brush strips KDR-BES-U are necessary.

## KDRS-BES-U

Enclosure gland plate, narrow,  
with brush strips  
for Rittal VX25 enclosures

The KDRS-BES-U consists of a narrow plate with matching brush strip with trim height 50 mm. The scope of delivery also includes a KDR-BES-U brush strip for sheet thicknesses of 2.5 – 3.0 mm with a trim height of 50 mm, which is mounted on the Rittal base plate. As a result, both brush strips are arranged in opposite directions and overlap.

The KDRS-BES-U gland plate with brush strip is very narrow. This allows the inserted cables to be inserted straight into the wiring duct.

The gland plate is fitted with threaded screw holes M8 on the left and right for earthing.

The gland plates KDRS-BES-U are designed for Rittal enclosures VX25.

### Advantages & benefits

- Easy assembly and removal
- The gland plate is very narrow. As a result, the inserted cables are inserted straight into the cable duct.
- Ideal for maintenance and retrofitting
- Space-saving solution
- The gland plate KDRS-BES-U are designed for Rittal enclosures VX25. Other sizes can be supplied on request.

### Specifications

Material	Gland plate: Sheet steel, zinc-plated Brush strip: Polyamid (PA)
Temperature	-20°C to +90°C (static)
Properties	Halogen free, silicone free

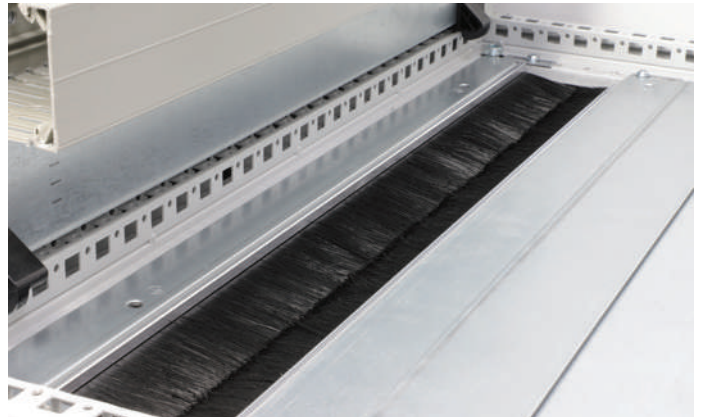

*Advantage KDRS: Straight cable routing into the cable duct due to the extremely narrow gland plate*



icotek can also produce enclosure gland plates for numerous other enclosure brands and in other sizes according to your wishes. Ask us at [pm@icotek.com](mailto:pm@icotek.com)!

## KDRS-BES-U

Enclosure gland plate, narrow,  
with brush strips  
for Rittal VX25 enclosures



Type	Enclosure type	Enclosure width	Sight size of base plate opening	Trim height	Order no.	PU
KDR-BES-U for Rittal enclosures VX 25						
KDRS-BES-U VX-25-600	VX 25	600 mm	452 mm	50 mm	58030	1
KDRS-BES-U VX-25-800	VX 25	800 mm	652 mm	50 mm	58031	1
KDRS-BES-U VX-25-1000	VX 25	1000 mm *	402 mm	50 mm	58032	1
KDRS-BES-U VX-25-1200	VX 25	1200 mm *	502 mm	50 mm	58033	1

## KDR-BES

### Enclosure gland plate with brush grommets

The 2-piece enclosure gland plates KDR-BES are supplied with preassembled brush grommets.

The gland plates are installed with standard Rittal clips.

Depending on the maximum cable diameter to be routed, the 2 halves of the brush gland plate are aligned further or closer to each other.

The gland plates KDR-BES are perfect for protection of the enclosure interiors against dirt.

#### Advantages & benefits

- During assembly, almost the complete base of the enclosure can be used for installation of cables.
- Retrofitting is possible without disconnecting of cables. All can be installed around the cables.
- The gland plates KDR-BES are designed for Rittal enclosures TS8. Other sizes can be supplied on request.

#### Specifications

Material	Gland plate: Sheet steel, zinc-plated Brush grommets: Polyamide (PA)
Temperature	-20°C to +90°C (static)
Properties	Halogen free, silicone free



### KDR-BES Assembly



# KDR-BES

## Enclosure gland plate with brush grommets



Type	Enclosure type	Enclosure width	Total length gland plate	Sight size of base plate opening	Order No.
KDR-BES-TS 8-600	Rittal TS8	600 mm	458 mm	435 mm	58000
KDR-BES-TS 8-800	Rittal TS8	800 mm	658 mm	635 mm	58006
KDR-BES-TS 8-1000	Rittal TS8	1000 mm without division bar	858 mm	835 mm	58012
KDR-BES-TS 8-1200	Rittal TS8	1200 mm*	518 mm	495 mm	58018

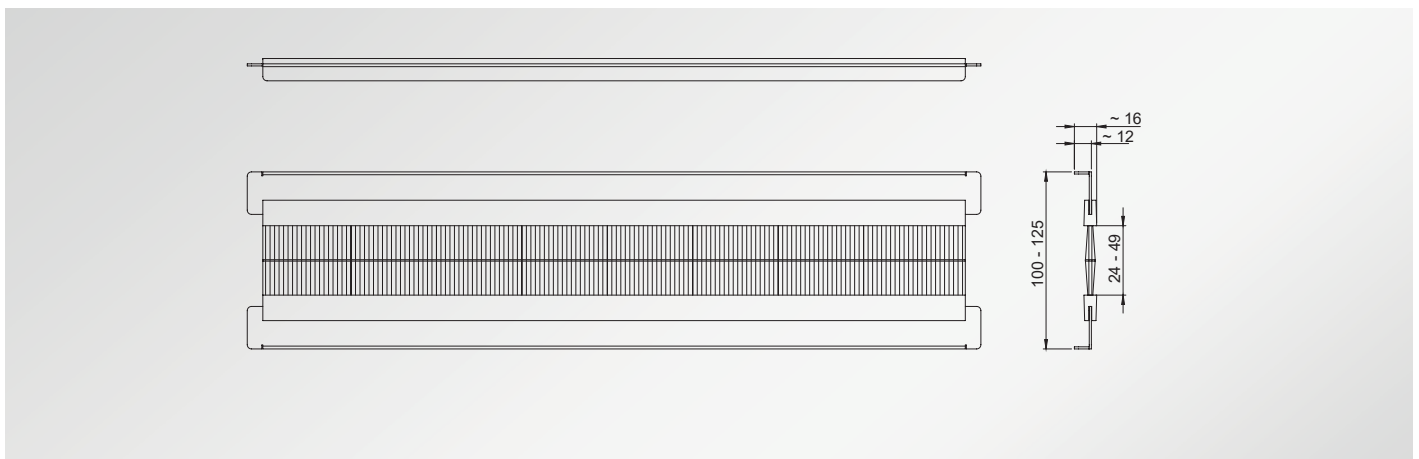

\* in case both fields of the enclosure are equipped, 2 complete gland plates are necessary.

# FP-AX-BES-U

## Split flange plates with brush strips



Two-part flange plates, each with two brush strips arranged in opposite directions with different trim heights (1 x 35 mm and 1 x 50 mm). They enable the routing of cables already pre-assembled with connectors and prevent dirt from entering the enclosure.  
The flange plates are designed for Rittal enclosures of type AX.

### Advantages & benefits

- Easy assembly
- Proven brush solution
- The use of two overlapping brush strips arranged in opposite directions increases tightness
- Ready for installation

### Specifications

Flange plate	Sheet steel glossy powder-coated, RAL 7035
Brush profile	Aluminium
Brush holder	Metal, galvanised
Bristles	Polyamide (PA)
Temperature	-20°C bis +90°C
Properties	Halogen free, silicone free



 icotek also produces flange plates with brush strips for numerous other enclosure brands. Ask us at [pm@icotek.com](mailto:pm@icotek.com)!

### Description

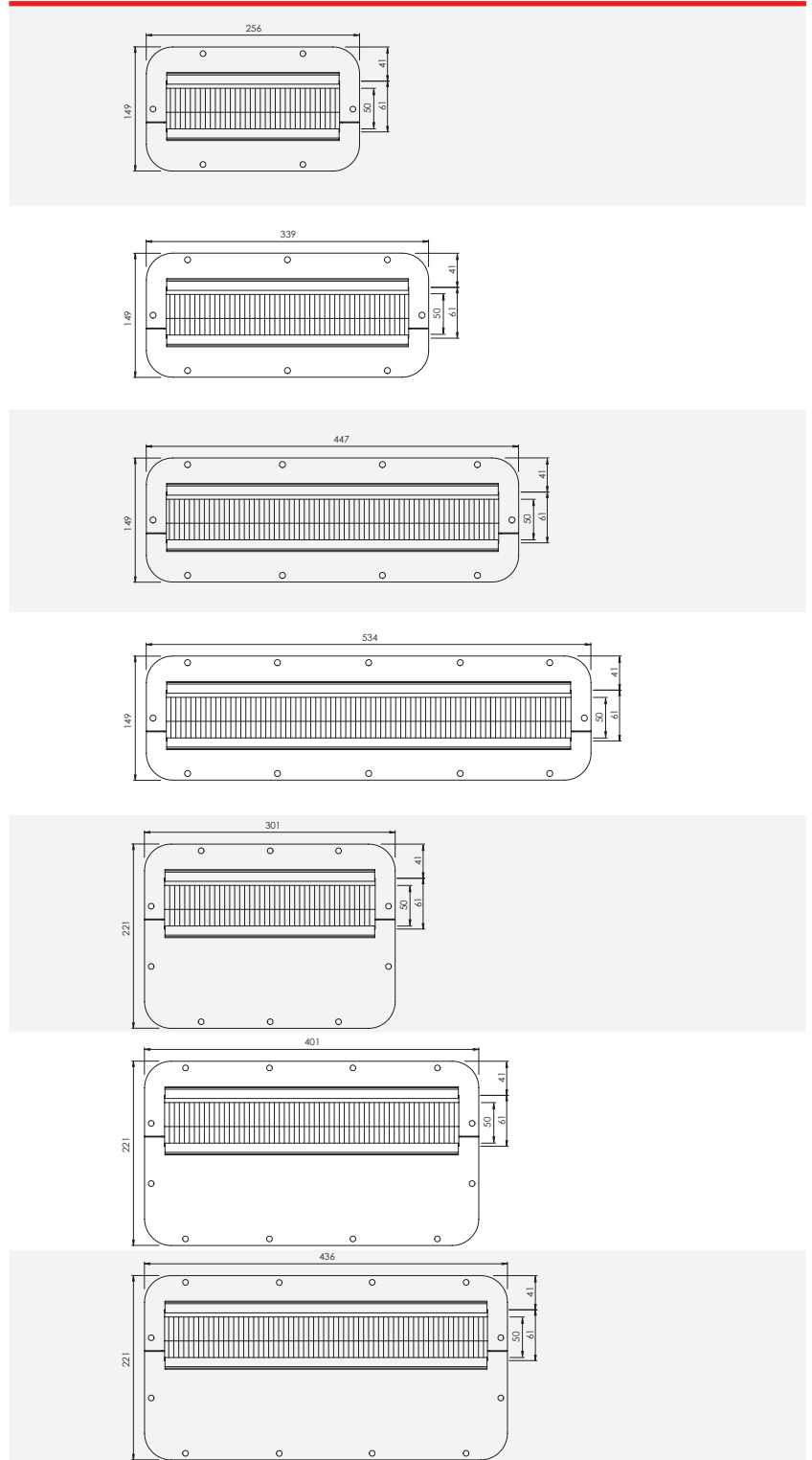

# FP-AX-BES-U

## Split flange plates with brush strips



Type	Size flange plate	suitable for	Order No.
FP-AX-BES-U 256 x 149 mm, two-part, mounted with KDR-BES-U trim height 35 mm + 50 mm	1	AX 1033.000 AX 1034.000	44100
FP-AX-BES-U 339 x 149 mm, two-part, mounted with KDR-BES-U trim height 35 mm + 50 mm	2	AX 1031.000 AX 1380.000 AX 1038.000 AX 1077.000 AX 1100.000 AX 1045.000	44101
FP-AX-BES-U 447 x 149 mm, two-part, mounted with KDR-BES-U trim height 35 mm + 50 mm	3	AX 1050.000 AX 1057.000	44102
FP-AX-BES-U 534 x 149 mm, two-part, mounted with KDR-BES-U trim height 35 mm + 50 mm	4	AX 1039.000 AX 1060.000 AX 1054.000 AX 1076.000 AX 1058.000 AX 1090.000	44103
FP-AX-BES-U 301 x 221 mm, two-part, mounted with KDR-BES-U trim height 35 mm + 50 mm	5	AX 1338.000 AX 1037.000 AX 1073.000 AX 1055.000 AX 1180.000 AX 1280.000 AX 1181.000 AX 1281.000	44104
FP-AX-BES-U 401 x 221 mm, two-part, mounted with KDR-BES-U trim height 35 mm + 50 mm	6	AX 1350.000 AX 1130.000 AX 1110.000 AX 1213.000 AX 1114.000 AX 1214.000 AX 1115.000	44105
FP-AX-BES-U 436 x 221 mm, two-part, mounted with KDR-BES-U trim height 35 mm + 50 mm	7	AX 1339.000 AX 1360.000 AX 1376.000 AX 1260.000 AX 1116.000 AX 1059.000 AX 1091.000 AX 1261.000	44106

7  
7.1  
7.2  
7.3

## BES 10 | BES 19

### Brush strips for the cable management in the 10" and 19" server rack

This brush strip from icotek is suitable for installation in 10" or 19" server racks from various manufacturers.

The special feature of the BES brush strip is that the integrated spring locks allow tool-free assembly and disassembly. All that is needed is to release the locking mechanism on both sides.

The network cables are simply passed through the brush strip. The cables are hidden from view inside the network cabinet. This gives a tidy appearance. The brush strip also prevents the ingress of dirt.

#### Advantages & benefits

- Suitable for 10" and 19" server racks from various manufacturers
- Tool-free assembly and disassembly
- Ready for installation

#### Specifications

Size	1 Rack Unit (1 RU)
Frame material	Metal
Bristles material	Polyamid (PA)
Colour	Black
Temperature	-30°C to +80°C

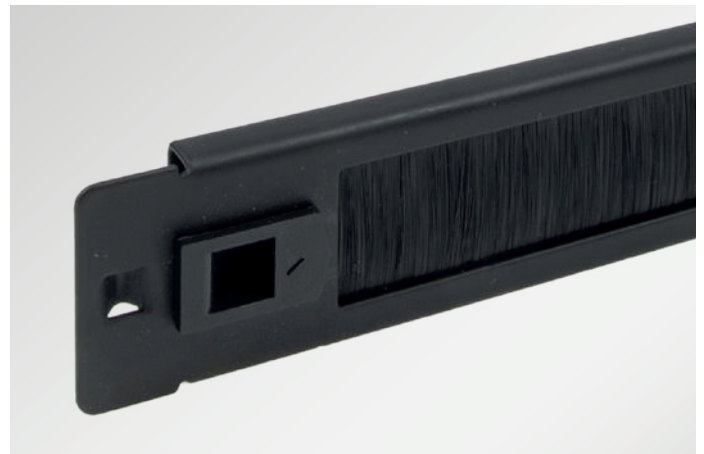



# BES 10 | BES 19

Brush strips for the cable management in the 10" and 19" server rack



Type	Enclosure type	Height	Length	Depth	Order No.	PU
BES 19 Cable management brush strip	Server rack 19"	44,5 mm	482 mm	12 mm	51500	1
BES 10 Cable management brush strip	Server rack 10"	44,5 mm	254 mm	12 mm	51501	1

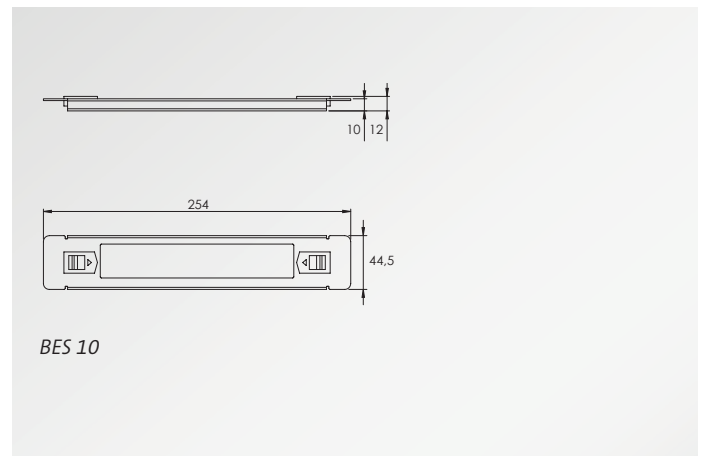
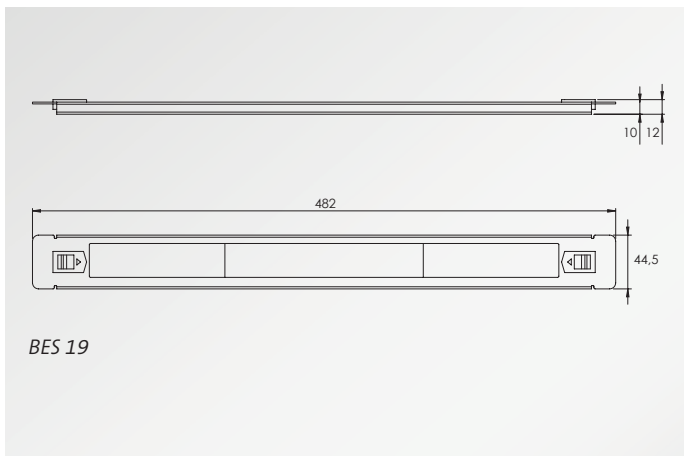



# icotek TOOLS

## Punch drivers, knockout punches and useful tools

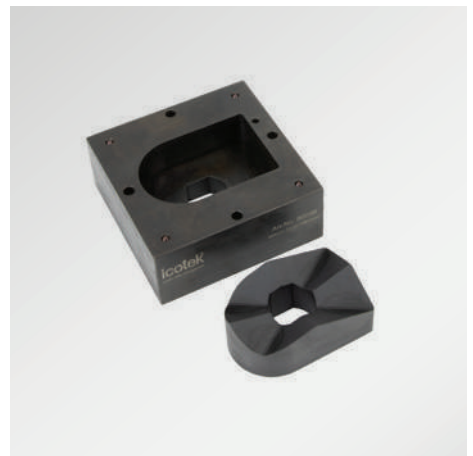

## 8 icotek TOOLS

### Punch drivers, knockout punches and useful tools

**icotek offers a small-sized hand hydraulic punch driver without a hose which allows quick and easy punching of rectangular, square or round holes. When you have to punch several holes, this hand hydraulic punch driver is much faster than manual wrench-style punches.**

icotek offers round knockout punches for cut-outs in metric and PG sizes. This self-centering knockout punches split slugs into 2 or 3 pieces for easy slug removal. For installation of pushbuttons and round switches icotek offers a 22.5 mm punch with integrated twist protection notch.

icotek also offers rectangular and square punches and dies, for cut-out sizes of 6-, 10-, 16-, 24- and 32-multi-pin industrial connectors as well as for most icotek cable entry systems.

#### Advantages & benefits

##### 1. Maximum flexibility

Due to its high hydraulic force the compact, lightweight hand hydraulic punch driver makes it easy to punch holes into stainless V2A steel, mild steel, aluminum or plastics. The cylinder of the punch driver rotates 360° on 3 axles. Therefore, maximum flexibility even in hard-to-reach places is provided.

##### 2. Multi-fold slug splitting

The special cutting geometry of the round punches reduces the cutting pressure and therefore the required effort. The punch splits slugs into several pieces for easy slug removal (type related).

##### 3. Perfect for icotek cable entry components

The metric round, rectangular and square knockout punches can be used for industrial standard cut-outs of heavy multi-pin connectors and many icotek cable entry components.





#### Punch driver sets

Hand hydraulic punch driver  
& round knockout die set, metric,  
Hydraulic Foot Pump

374 – 376



#### Rail cutters

for top hat DIN rails and bus bars

DIN-RC 1 / DIN-RC 2

377

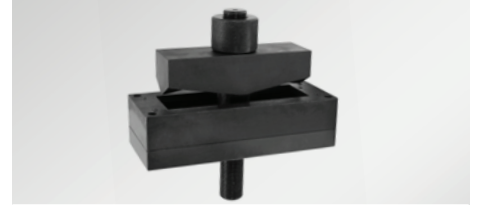

#### Rectangular & square punches

for cut-outs of heavy multi-pin industrial  
connectors and many icotek cable entry  
components  
for steel, aluminium

378 – 379

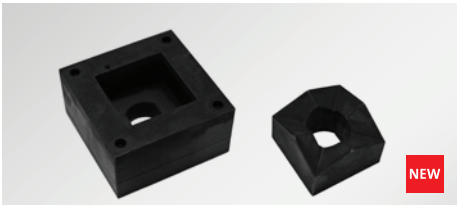

Rectangular & square punches  
for cut-outs in special sizes  
for steel, aluminium

380 – 381

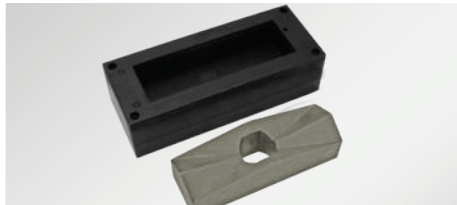

#### Rectangular & square punches

for cut-outs of heavy multi-pin industrial  
connectors and many icotek cable entry  
components for stainless steel

382 – 383



#### Round punches

for cut-outs in PG and metric sizes,  
for steel, aluminium

384 – 385



#### Round punches

for cut-outs in PG and metric sizes,  
for stainless steel

386 – 387

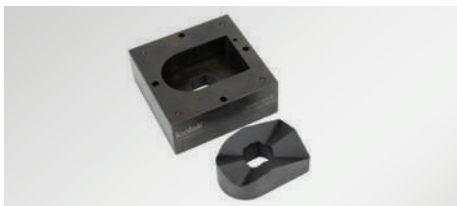

#### Punches CONFiX

for CONFiX cable conduit system  
and KEL-FW cable entry,  
for steel, aluminium, stainless steel

388 – 389



#### Useful Tools

for measuring and mounting

391

## Punch driver sets

### Hand hydraulic punch driver and metric punches

The compact, lightweight hand hydraulic punch driver makes it easy to punch holes into stainless V2A steel, mild steel, aluminium or plastics with a max. sheet thickness of 3 mm (V2A: 2 mm), due to its high hydraulic force. The cylinder of the punch driver rotates 360° on 3 axes, so maximum flexibility even in hard-to-reach places is provided.

The punch driver can be used with all icotek punches and also with punches of other manufacturers.

#### Advantages & Benefits

- Maximum flexibility due to 360° head rotation
- High hydraulic force (60 kN, 600 bar) for easy punching
- Compact, lightweight aluminium design (2 kg)
- Fast and easy operation
- Punch driver also suitable for punches by other manufacturers

#### Specifications

Material	Aluminium
Punching force	60 kN
Operating pressure	600 bar

#### Accessories

Round punches	384 - 387
Rectangular & square punches	378 - 383



LIGHT



PRO 16-63

# Punch driver sets

## Hand hydraulic punch driver and metric punches

Type	Scope of delivery	Order No.	PU
Punch driver set BASIC	<ul style="list-style-type: none"> <li>1 hand hydraulic punch driver (weight: 2 kg)</li> <li>1 draw stud for punches (steel) <math>\phi</math> 9.5 mm (3/8" UNF) to <math>\phi</math> 19 mm (3/4" UNF), L: 105 mm</li> <li>1 draw stud <math>\phi</math> 19 mm (3/4" UNF), L: 125 mm</li> <li>1 spacer</li> <li>1 tube lubricant</li> <li>1 HSS co pilot drill (multi step drill)</li> <li>1 robust plastic storage case</li> </ul>	80000	1
Punch driver set PRO 16-32	<ul style="list-style-type: none"> <li>1 hand hydraulic punch driver (weight: 2 kg)</li> <li>1 draw stud for punches (steel) <math>\phi</math> 9.5 mm (3/8" UNF) to <math>\phi</math> 19 mm (3/4" UNF), L: 105 mm</li> <li>1 draw stud <math>\phi</math> 19 mm (3/4" UNF), L: 125 mm</li> <li>1 spacer</li> <li>1 tube lubricant</li> <li>1 HSS co pilot drill (multi step drill)</li> <li>1 each knockout punch for steel M16   M20   M25   M32</li> <li>1 robust plastic storage case</li> </ul>	80005	1
Punch driver set PRO 16-63	<ul style="list-style-type: none"> <li>1 hand hydraulic punch driver (weight: 2 kg)</li> <li>1 draw stud for punches (steel) <math>\phi</math> 9.5 mm (3/8" UNF) to <math>\phi</math> 19 mm (3/4" UNF), L: 105 mm</li> <li>1 draw stud <math>\phi</math> 19 mm (3/4" UNF), L: 125 mm</li> <li>1 spacer</li> <li>1 tube lubricant</li> <li>1 HSS co pilot drill (multi step drill)</li> <li>1 each knockout punch for steel M16   M20   M25   M32   M40   M50   M63</li> <li>1 robust plastic storage case</li> </ul>	80006	1
Punch driver set PRO 16-63 for stainless steel	<ul style="list-style-type: none"> <li>1 hand hydraulic punch driver (weight: 2 kg)</li> <li>1 draw stud for punches (stainless steel) <math>\phi</math> 9.5 mm (3/8" UNF) to <math>\phi</math> 19 mm (3/4" UNF), L: 105 mm</li> <li>1 draw stud <math>\phi</math> 11 mm (3/4" UNF), L: 125 mm</li> <li>1 spacer</li> <li>1 tube lubricant</li> <li>1 HSS co pilot drill (multi step drill)</li> <li>1 each knockout punch for stainless steel M16   M20   M25   M32   M40   M50   M63</li> <li>1 robust plastic storage case</li> </ul>	80072	1
<b>NEW</b> Punch driver set LIGHT	<ul style="list-style-type: none"> <li>1 hand hydraulic punch driver (weight: 2 kg)</li> <li>1 draw stud for round punches for sheet steel, M16   M20   M25, <math>\phi</math> 9.5 mm (3/8" UNF) to <math>\phi</math> 19 mm (3/4" UNF), L: 105 mm</li> <li>1 draw stud for round punches for sheet steel and stainless steel V2A, M32   M40   M50   M63   M85 <math>\phi</math> 19 mm (3/4" UNF), L: 125 mm</li> <li>1 spacer, 1 robust plastic storage case</li> </ul>	80003	1

# Punch driver sets

## Hydraulic foot pump

### Hydraulic foot pump with hydraulic cylinder and accessories

Universally applicable single-stage foot pump with a fixed operating pressure of 450 bar and built-in pressure relief valve. Suitable for all icotek round punches, rectangular and square punches. Keeps your hands free to position the sheet metal punch precisely, especially when using larger sheet metal punches.

Type	Scope of delivery	Order No.	PU
Hydraulic foot pump	1 foot pump 2,5 m high pressure hose including quick coupling 1 hydraulic cylinder for holding round and rectangular punch 1 draw stud for rectangular punch, Order No. 80209 1 draw stud for round punch (steel) M16 – M25, Order No. 80200 1 multi-step drill, Order No. 80204 1 spacer, Order No. 80202 1 tube lubricant, Order No. 80203 Note: storage case not included in delivery	80002	1





# DIN-RC 1 | DIN-RC 2

## Rail cutters for top hat DIN rails and bus bars



The DIN-RC 1 and DIN-RC 2 cutters cut various top hat DIN rails and bus bars. The cut is clean and burr-free, there is no waste. The length stop with guiding device ensures that nothing slips during cutting and that the cut is always accurate to size.

**DIN-RC 1** is suitable for cutting top hat DIN rails 35 x 7.5 mm and top hat DIN rails 35 x 15 mm.

**DIN-RC 2** is suitable for cutting top hat DIN rails 35 x 7.5 mm, DIN rails 35 x 15 mm, DIN rails 15 x 5.5 mm and bus bars 10 x 3 mm.

### Advantages & benefits

- Cuts the most common rails and bars  
DIN-RC 1: DIN rails 35 x 7.5 mm and 35 x 15 mm  
DIN-RC 2: DIN rails 35 x 7.5 mm, 35 x 15 mm and 15 x 5.5 mm as well as bus bars 10 x 3 mm
- Exact 90° cuts
- Burr-free cuts
- With length stop 1000 mm and guiding device

Type	Description	Order No.	PU
DIN-RC 1	Rail cutter for DIN rails with length stop 1000 mm	80189	1
DIN-RC 2	Rail cutter for DIN rails and bus bars with length stop 1000 mm	80190	1

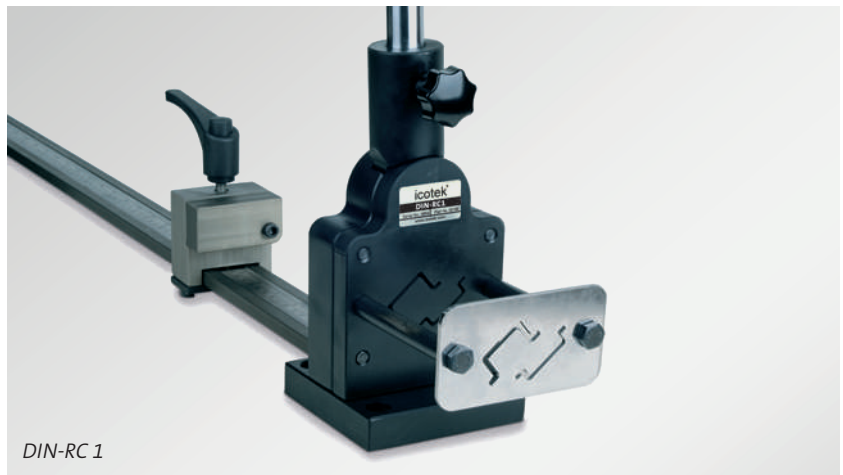

### DIN-RC 1:

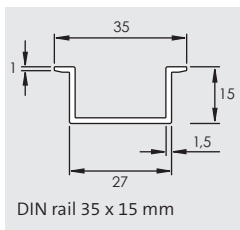
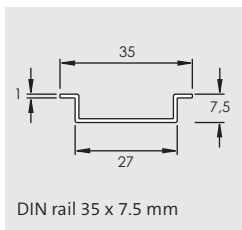

### DIN-RC 2 additionally:

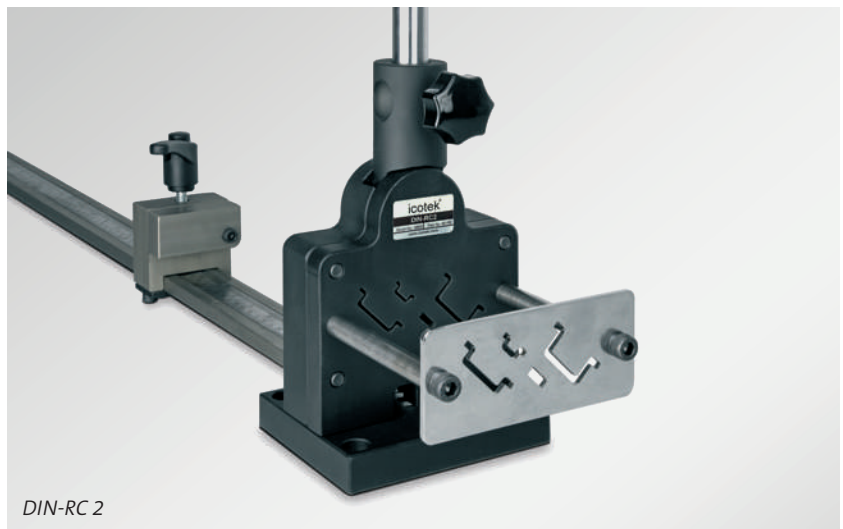
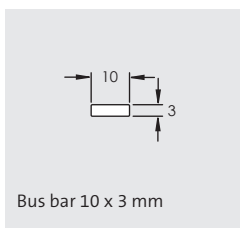
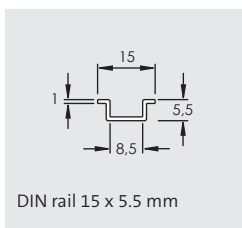

# Rectangular & square punches

sized for heavy multi-pin industrial connectors  
and icotek cable entry systems  
for steel and aluminium

Rectangular and square punches and dies make it easy to punch holes into mild steel, aluminium or plastics with a max. sheet thickness of 2 mm. Available for cut-outs for the most common sizes of heavy industrial connectors and also for numerous special cut-outs. Therefore, the punches are suitable for most icotek cable entry systems. Centre punches are integrated in the die for exact drilling of mounting holes.

The punches are for hydraulic operation only.

### Advantages & benefits

- Centre punches for exact drilling of mounting holes
- Robust plastic storage case
- Suitable for hand hydraulic punch driver by icotek and other manufacturers

### Specifications

Material Steel, hardened and burnished

### Scope of delivery

Punch, die, counter nut and draw stud, robust plastic storage case

### Compatible with

Hydraulic punch driver 374 - 376

### Complete set

Type	Cut-out size
Punch E1	21 x 27 mm
Punch E2	24 x 43 mm
Punch E3	24 x 65 mm
Punch E4	24 x 86 mm
Punch E5	24 x 112 mm
Punch 6	36 x 52 mm
Punch B	46 x 46 mm
Punch 10	36 x 65 mm
Punch 16	36 x 86 mm
Punch 24	36 x 112 mm
Punch 24-XL	46 x 112 mm
Punch 24-E *   **	66 x 112 mm
Punch KEA <span style="background-color: red; color: white; padding: 2px;">NEW</span>	56 x 112 mm

\* Storage case not included in delivery

\*\* Only to be used with hydraulic foot pump (order no. 80002).





### Compatible spare parts

Max. sheet thickness	For cut-out of connector	With centre punch (number)	Order No.	PU	Draw stud Art.-Nr.	Counter nut Art.-Nr.	Centre punch Art.-Nr.
2 mm	–	–	80075	1	80205	80227	–
2 mm	–	2	80055	1	80226	80211	80065
2 mm	–	2	80056	1	80226	80211	80065
2 mm	–	2	80057	1	80226	80211	80065
2 mm	–	2	80058	1	80226	80211	80065
2 mm	6-pin	4	80062	1	80209	80211	80065
2 mm	–	4	80049 80050	1	80209	80211	80065 –
2 mm	10-pin	4	80051	1	80209	80211	80065
2 mm	16-pin	4	80052	1	80209	80211	80065
2 mm	24-pin	4	80053	1	80209	80211	80065
2 mm	24-pin	4	80054	1	80209	80211	80065
2 mm	32-pin	–	80061	1	80209	80211	–
2 mm	–	4	80101	1	80209	80211	80065

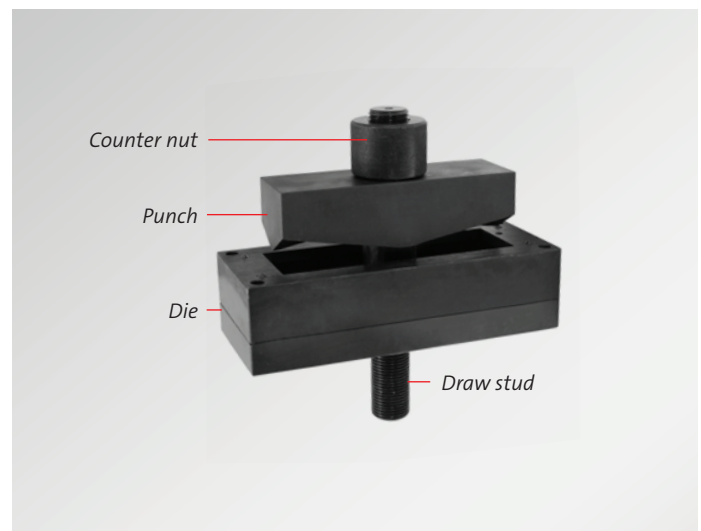

# Rectangular & square punches for steel and aluminium in special sizes

NEW

The special size sheet metal punches can be used for cut-outs such as appliance fan cut-outs as well as custom cut-outs. Other special sizes are available on request.

Centre punches are integrated in the die for exact drilling of mounting holes. For max. 2 mm sheet steel, aluminium and plastic. The punches are for hydraulic operation only.

## Advantages & benefits

- Centre punches for exact drilling of mounting holes
- Robust plastic storage case
- Suitable for hand hydraulic punch driver by icotek and other manufacturers

## Specifications

Material Steel, hardened and burnished

## Scope of delivery

Punch, die, counter nut and draw stud, robust plastic storage case

## Compatible with

Hydraulic punch driver 374 - 376

## Complete set

Type	Cut-out size
Punch 68x68 **	68 x 68 mm
Punch 92x92 **	92 x 92 mm
Punch 125x125 *   **	125 x 125 mm
Punch 138 x 138 *   **	138 x 138 mm
Punch SUB-D9-pin	—
Punch 12,7 x 12,7	12,7 x 12,7 mm
Punch D 15,4 x 14,5	15,4 x 14,5 mm one side flattened to 14,5 mm
Punch 15,8 x 15,8	15,8 x 15,8 mm
Punch D 16,4 x 15,3	16,4 x 15,3 mm one side flattened to 15,3 mm
Punch 17 x 19	17 x 19 mm
Punch 19,1 x 19,1	19,1 x 19,1 mm
Punch 21,3 x 21,3	21,3 x 21,3 mm
Punch 22 x 30	22 x 30 mm
Punch 22 x 42	22 x 42 mm
Punch 22 x 45	22 x 45 mm
Punch 22,2 x 22,2	22,2 x 22,2 mm
Punch 24 x 24	24 x 24 mm
Punch 24 x 57	24 x 57 mm
Punch 25 x 50	25 x 50 mm
Punch 25,4 x 25,4	25,4 x 25,4 mm
Punch 32 x 90	32 x 90 mm
Punch 45 x 92	45 x 92 mm
Punch 46 x 92	46 x 92 mm
Punch 50,8 x 50,8	50,8 x 50,8 mm
Punch 65 x 113 *	65 x 113 mm
Punch 68 x 138 *	68 x 138 mm
Punch 71 x 29	71 x 29 mm
Punch 73 x 24	73 x 24 mm
Punch 91 x 117 *	91 x 117 mm



\* Storage case not included in delivery

\*\* Only to be used with hydraulic foot pump (Order no. 80002).

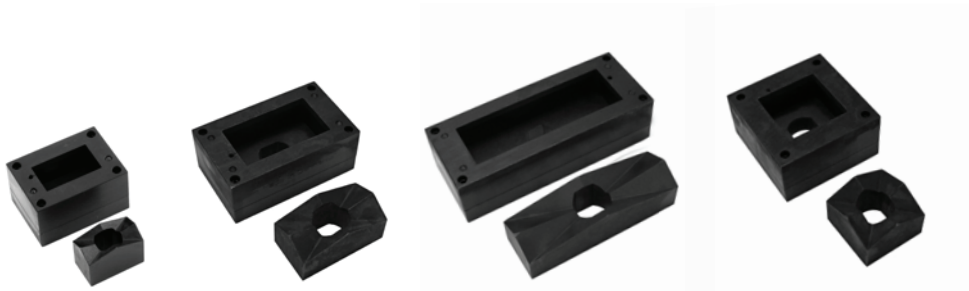

### Compatible spare parts

Max. sheet thickness	For cut-out of connector	With centre punch (number)	Order No.	PU	Draw stud Art.-Nr.	Counter nut Art.-Nr.	Centre punch Art.-Nr.
2 mm	–	–	80064	1	80209	80211	–
2 mm	–	–	80060	1	80209	80211	–
2 mm	–	–	80063	1	80213***	80214***	–
2 mm	–	–	80086	1	80213	80214	–
2 mm	SUB-D 9-pin	–	80073	1	80228	80229	–
2 mm	–	–	80079	1	80228	80229	–
2 mm	–	–	80220	1	80228	80229	–
2 mm	–	–	80080	1	80228	80229	–
2 mm	–	–	80222	1	80228	80229	–
2 mm	–	–	80087	1	80228	80229	–
2 mm	–	–	80081	1	80205	80227	–
2 mm	–	2	80082	1	80205	80227	80232
2 mm	–	–	80088	1	80205	80227	–
2 mm	–	–	80089	1	80205	80227	–
2 mm	–	–	80059	1	80205	80227	–
2 mm	HAN 3A	2	80067	1	80205	80227	80232
2 mm	–	–	80083	1	80205	80227	–
2 mm	–	4	80223	1	80226	80211	80065
2 mm	–	–	80091	1	80231	80227	–
2 mm	–	–	80084	1	80205	80227	–
2 mm	–	–	80159	1	80226	80211	–
2 mm	–	–	80092	1	80209	80211	–
2 mm	–	–	80093	1	80209	80211	–
2 mm	–	–	80085	1	80209	80211	–
2 mm	–	–	80074	1	80209	80211	–
2 mm	–	–	80094	1	80213	80214	–
2 mm	–	–	80161	1	80226	80211	–
2 mm	–	4	80224	1	80226	80211	80065
2 mm	–	–	80066	1	80209	80211	–

\*\*\* Order numbers 80213 and 80214 are required

# Rectangular & square punches

sized for heavy multi-pin industrial connectors  
and icotek cable entry systems  
for stainless steel

Rectangular and square punches and dies make it easy to punch holes into stainless steel (V2A versions) with a max. sheet thickness of 2 mm. Available for cut-outs for the most common sizes of heavy industrial connectors and also for numerous special cut-outs. Therefore, the punches are suitable for most icotek cable entry systems. Centre punches are integrated in the die for exact drilling of mounting holes.

The punches are for hydraulic operation only.

### Advantages & benefits

- Centre punches for exact drilling of mounting holes
- Robust plastic storage case
- Suitable for hand hydraulic punch driver by icotek and other manufacturers

### Specifications

Material                      Steel, hardened and burnished

### Scope of delivery

Punch, die, counter nut and draw stud, robust plastic storage case

### Compatible with

Hydraulic punch driver                      374 - 376

### Complete set

Type	Cut-out size
Punch 6 for stainless steel V2A	36 x 52 mm
Punch B for stainless steel V2A	46 x 46 mm
Punch 10 for stainless steel V2A	36 x 65 mm
Punch 16 for stainless steel V2A	36 x 86 mm
Punch 24 for stainless steel V2A	36 x 112 mm
Punch 24-XL for stainless steel V2A	46 x 112 mm
Punch KEA for stainless steel V2A	112 x 56 mm
Punch 22,2 x 22,2 for stainless steel V2A	22,2 x 22,2 mm





### Compatible spare parts

Max. sheet thickness	For cut-out of connector	With centre punch (number)	Order No.	PU	Draw stud Order No.	Counter nut Order No.	Centre punches Order No.
2 mm	6-pin	4	80149	1	80209	80211	80065
2 mm	–	4	80150	1	80209	80211	80065
2 mm	10-pin	4	80151	1	80209	80211	80065
2 mm	16-pin	4	80152	1	80209	80211	80065
2 mm	24-pin	4	80153	1	80209	80211	80065
2 mm	24-pin	4	80154	1	80209	80211	80065
2 mm	–	4	80225	1	80209	80211	80065
2 mm	HAN 3A	3	80148	1	80205	80227	80232

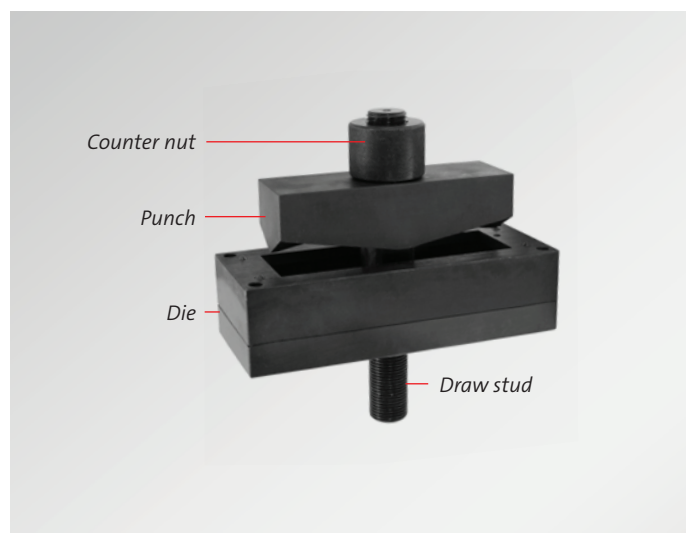

# Round punches

for steel and aluminium,  
for cut-outs M16 – M85, PG



Punch set M16 – M63  
Order No. 80007

Self-centering knockout punches for mild steel, aluminium and plastic walls. Punches available for cut-outs PG 16, M16, M20, M25, M32, M40, M50, M63, M75 and M85. Cut-outs for icotek split cable glands and round cable entry plates can be punched.

The special cutting geometry of the punch reduces the cutting pressure and therefore the required effort. The punch splits slugs into several pieces (type related)\* for easy slug removal. For installation of round switches icotek offers a PG 16 punch with an integrated 3 mm twist protection notch.

The punches are designed for manual and hydraulic operation.

### Advantages & benefits

- Multiple splitting punches for easier slug removal/ for easy punching
- Suitable with hand hydraulic punch driver by icotek or other manufacturers

### Specifications

Material Steel, hardened and burnished

### Scope of delivery

Punch and die (without draw stud)

### Compatible with

Hydraulic punch driver 374 - 375



### Complete set

Type	Cut-out size $\phi$
Punch Set M16 – M63	16,2 – 63,5 mm
Punch M16	16,2 mm
Punch M20	20,4 mm
Punch M25	25,4 mm
Punch M32	32,5 mm
Punch M40	40,5 mm
Punch M50	50,5 mm
Punch M63	63,5 mm
Punch M75	75,5 mm
Punch M80	80 mm
Punch M85	86 mm
Punch 22	NEW 22 mm
Punch 43,2	NEW 43,2 mm
Punch Set PG 7 – PG 48; 30,5 mm	NEW 12,5 – 59,3 mm
Punch PG 11	NEW 18,6 mm
Punch PG 13 (M20)	NEW 20,4 mm
Punch PG 16	22,5 mm
Punch PG 16 with twist protection notch	22,5 mm + 3 mm notch
Punch PG 21	NEW 28,3 mm





3-fold slug splitting



Compatible spare parts

Max. sheet thickness	Thread Ø	Order No.	PU	Draw stud Order No.	Counter nut Order No.
M16 – M25: 2,0 mm M32 – M63: 2,5 mm	9,5 mm/19 mm	80007	1	–	–
2 mm	9,5 mm	80020	1	80200	–
2 mm	9,5 mm	80021	1	80200	–
2 mm	9,5 mm	80022	1	80200	–
3 mm	19 mm	80023	1	80201	–
3 mm	19 mm	80024	1	80201	–
3 mm	19 mm	80025	1	80201	–
3 mm	19 mm	80026	1	80201	–
2,5 mm	19 mm	80029	1	80201	–
2,5 mm	19 mm	80034	1	80201	–
2 mm	19 mm	80030	1	80201	–
2 mm	9,5 mm	80221	1	80201	–
2,5 mm	19 mm	80068	1	80201	–
2 mm – 9,5 mm; 2,5 mm – 19 mm	9,5 mm; 19 mm	80008	1	–	–
2 mm	9,5 mm	80160	1	80210	–
2 mm	9,5 mm	80021	1	80210	–
2 mm	9,5 mm	80027	1	80210	–
2 mm	9,5 mm	80028	1	80205	80227
2 mm	9,5 mm	80157	1	80210	–

# Round punches for stainless steel, for cut-outs PG & M16 – M85

Self-centering knockout punches for stainless steel (V2A versions). Punches available for cut-outs PG 16, M16, M20, M25, M32, M40, M50, M63, M75 and M85. Cut-outs for icotek split cable glands and round cable entry plates can be punched.

The special cutting geometry of the punch reduces the cutting pressure and therefore the required effort. The punch splits slugs into two pieces for easy slug removal. For installation of round switches icotek offers a PG 16 punch with an integrated 3 mm twist protection notch.

The punches are designed for manual and hydraulic operation.

## Advantages & benefits

- Multiple splitting punches for easier slug removal/for easy punching
- Suitable with hand hydraulic punch driver by icotek or other manufacturers

## Specifications

Material Steel, hardened and burnished

## Scope of delivery

Punch and die (without draw stud)

## Compatible with

Hydraulic punch driver 374 - 375



## Complete set

Type	Cut-out size ø
Punch Set M16 – M63, for stainless steel V2A	16,2 – 63,5 mm
Punch M16** for stainless steel V2A	16,2 mm
Punch M20** for stainless steel V2A	20,4 mm
Punch M25** for stainless steel V2A	25,4 mm
Punch M32 for stainless steel V2A	32,5 mm
Punch M40 for stainless steel V2A	40,5 mm
Punch M50 for stainless steel V2A	50,5 mm
Punch M63 for stainless steel V2A	63,5 mm
Punch M75 for stainless steel V2A	NEW 75 mm
Punch 43,2mm for stainless steel V2A	NEW 43,2 mm
Punch PG11 for stainless steel V2A	NEW 18,6 mm
Punch PG13 (M20) for stainless steel V2A	NEW 20,4 mm
Punch PG16 for stainless steel V2A	NEW 22,5 mm
Punch PG 16 with twist protection notch for stainless steel V2A	22,5 mm + 3 mm Nase
Punch PG21 for stainless steel V2A	NEW 28,3 mm
Punch PG42 for stainless steel V2A	NEW 54 mm

\*\*Draw stud (Order No. 80210) is required.  
Note: More PG sizes are available on request.



2-fold slug splitting

Compatible spare parts

Max. sheet thickness	Thread Ø	Order No.	PU	Draw stud Order No.	Counter nut Order No.
2 mm	11,1 mm/19 mm	80070	1	–	–
2 mm	11,1 mm	80120	1	80210	–
2 mm	11,1 mm	80121	1	80210	–
2 mm	11,1 mm	80122	1	80210	–
2 mm	19 mm	80123	1	80201	–
2 mm	19 mm	80124	1	80201	–
2 mm	19 mm	80125	1	80201	–
2 mm	19 mm	80126	1	80201	–
2 mm	19 mm	80071	1	80201	–
2 mm	19 mm	80158	1	80201	–
2 mm	11,1 mm	80155	1	80210	–
2 mm	11,1 mm	80156	1	80210	–
2 mm	11,1 mm	80069	1	80210	–
1,5 mm	9,5 mm	80128	1	80205	80227
2 mm	19 mm	80031	1	80201	–
2 mm	19 mm	80032	1	80201	–

# Punches CONFiX

for CONFiX cable conduit system  
and KEL-FW cable entry,  
for steel, aluminium, stainless steel

These punches can be used to punch the special cut-out shapes for the CONFiX bulkhead fittings.

In addition, the 80100 and 80194 punches can be used to punch the cut-outs for the KEL-FW cable entry.

For max. 2 mm stainless steel (V2A versions), sheet steel, aluminium and plastic.

The punches are suitable for the hand hydraulic punch driver and the hydraulic foot pump.

The punches are supplied with draw stud and counter nut in a transport case.

## Advantages

- For the special cut-out shapes for CONFiX and KEL-FW
- High-quality padded transport case
- Suitable with hand hydraulic punch driver by icotek or other manufacturers

## Specifications

Material Steel, hardened and burnished

## Compatible with

Hydraulic punch driver 374 - 375  
Hydraulic foot pump 317

## Complete set

Type	Cut-out size
<b>Punches for steel and aluminium</b>	
Punch CONFiX	22,6 x 22 mm
Punch CONFiX	28 x 37 mm
Punch CONFiX	40 x 64,5 mm
Punch CONFiX	48,4 x 79,5 mm
Punch CONFiX*	83,25 x 60,5 mm
Punch KEL-FW*	62 x 86 mm
<b>Punches for stainless steel V2A</b>	
Punch CONFiX	22,6 x 22 mm
Punch CONFiX	28 x 37 mm
Punch CONFiX	40 x 64,5 mm
Punch CONFiX	48,4 x 79,5 mm
Punch CONFiX*	83,25 x 60,5 mm
Punch KEL-FW*	62 x 86 mm

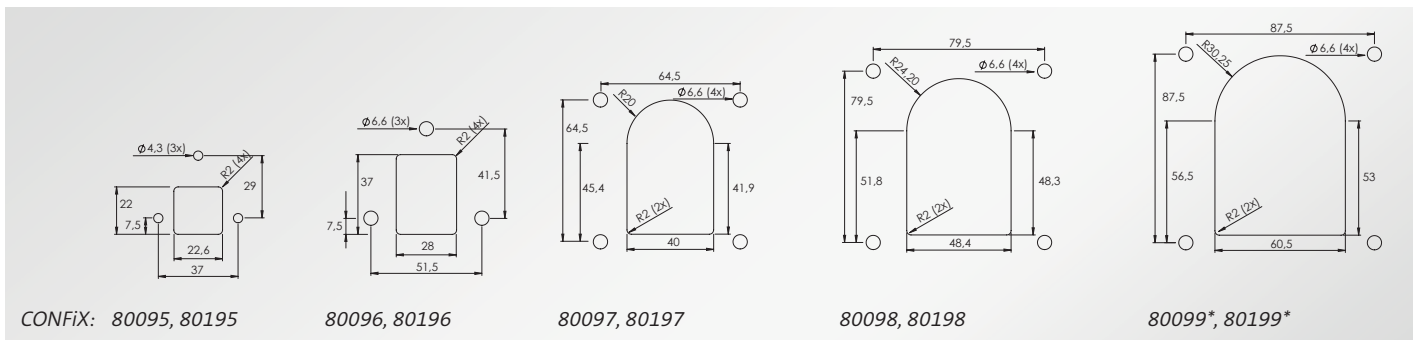

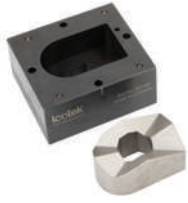

### Compatible spare parts

Max. sheet thickness	Suitable for	With centre punch (number)	Order No.	PU	Draw stud Order No.	Counter nut Order No.	Centre punches Order No.
2 mm	FWS-A 16 FWS-A 20 FWS-B 11 FWS-B 16	3	80095	1	80205	80227	80232
2 mm	FWS-A 25 FWS-B 21	3	80096	1	80205	80227	80232
2 mm	FWS-A 32 FWS-B 29	4	80097	1	80209	80211	80065
2 mm	FWS-A 40 FWS-B 36	4	80098	1	80209	80211	80065
2 mm	FWS-A 50 FWS-B 48	4	80099	1	80209	80211	80065
2 mm	KEL-FW B1 KEL-FW B4	4	80100	1	80209	80211	80065
2 mm	FWS-A 16 FWS-A 20 FWS-B 11 FWS-B 16	3	80195	1	80205	80227	80232
2 mm	FWS-A 25 FWS-B 21	3	80196	1	80205	80227	80232
2 mm	FWS-A 32 FWS-B 29	4	80197	1	80209	80211	80065
2 mm	FWS-A 40 FWS-B 36	4	80198	1	80209	80211	80065
2 mm	FWS-A 50 FWS-B 48	4	80199	1	80209	80211	80065
2 mm	KEL-FW B1 KEL-FW B4	4	80194	1	80209	80211	80065

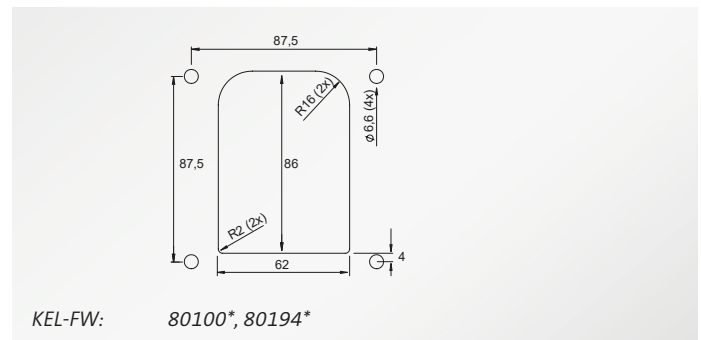

## Accessories for punches



### Draw studs

Type	Compatible for	Order No.	PU
Draw stud	for rectangular punch D = 19 mm, Length: 135 mm	80209	1
Draw stud	for rectangular punch, one side flattened D = 13 mm, d = 11 mm, Length: 105 mm	80205	1
Draw stud	for rectangular punch, two sides flattened Order No. 80063, 80086	80213	1
Draw stud	for rectangular punch 19 x 14 x 130 mm, two sides flattened	80226	1
Draw stud	for rectangular punch 9,5 x 8,25 x 105 mm, one side flattened	80228	1
Draw stud	for rectangular punch, Order No. 80091 16 x 14,5 x 110 mm	80231	1
Draw stud	for round punch (steel) M16 – M25 d = 9,5 mm; D = 19 mm; L = 105 mm	80200	1
Draw stud	for round punch (steel and stainless steel V2A) M32 – M85, D = 19 mm; L = 125 mm	80201	1
Draw stud	for round punch M16, M20, M25 (steel and stainless steel V2A) with adapter 11,1 x 19,0 mm, L = 105 mm	80210	1

### For manual operation

Type	Compatible for	Order No.	PU
Ball bearing mounted pressure screw	for round punch M16 – M25, screw 9,5 x 50 mm, UNF 3/8 thread	80217	1
Ball bearing mounted pressure screw	for round punch M32 – M40, screw 19 x 55 mm UNF 3/4 thread	80218	1
Ball bearing mounted pressure screw	for round punch M50, screw 19 x 75 mm UNF 3/4 thread	80219	1
Pressure nut with ball bearing	1/2 UNF	80207	1
Pressure nut with ball bearing	3/8 UNF	80230	1



### Counter nuts

Type	Compatible for	Order No.	PU
Counter nut	1/2 UNF	80206	1
Counter nut	for rectangular punch 125 x 125 mm Order No. 80063, 80086	80214	1
Counter nut	3/4 UNF	80211	1
Counter nut	3/8 UNF	80229	1

### Centre punches

Type	Compatible for	small   large	Order No.	PU
Centre punches	Rectangular punches	large	80065	1
Centre punches	80082, 80095, 80096, 80148	small	80232	1

### Other accessories

Type	Compatible for	Order No.	PU
Multi-stage drill	HSS co-drill	80204	1
Adapter	3/4 to 1/2 UNF	80208	1
Adapter	3/4 to 3/8 UNF	80234	1

## Useful Tools for measuring and mounting



**KMS**  
Cable template

Description	Order No.	PU
Cable template	39800	1

The correct size of the KT grommets can easily be determined by using the cable template

- Determining the diameter of the cable using the cable template
- Selecting the KT grommets according to the data on the cable template



**QVT-CLICK Tool**  
Mounting tool

Description	Order No.	PU
QVT-CLICK Tool	61435	1

The QVT-CLICK Tool for a quick and easy mounting of the split cable glands QVT-CLICK (see page 111)



**Wrenches**  
for plastic locknuts M75/M85

Description	Material	Order No.	PU
Wrench M75	Aluminium	61436	1
Wrench M85	Aluminium	61437	1

For mounting the KEL-DPF sizes we offer suitable wrenches with widths for M75 and M85 plastic locknuts. Material: aluminium









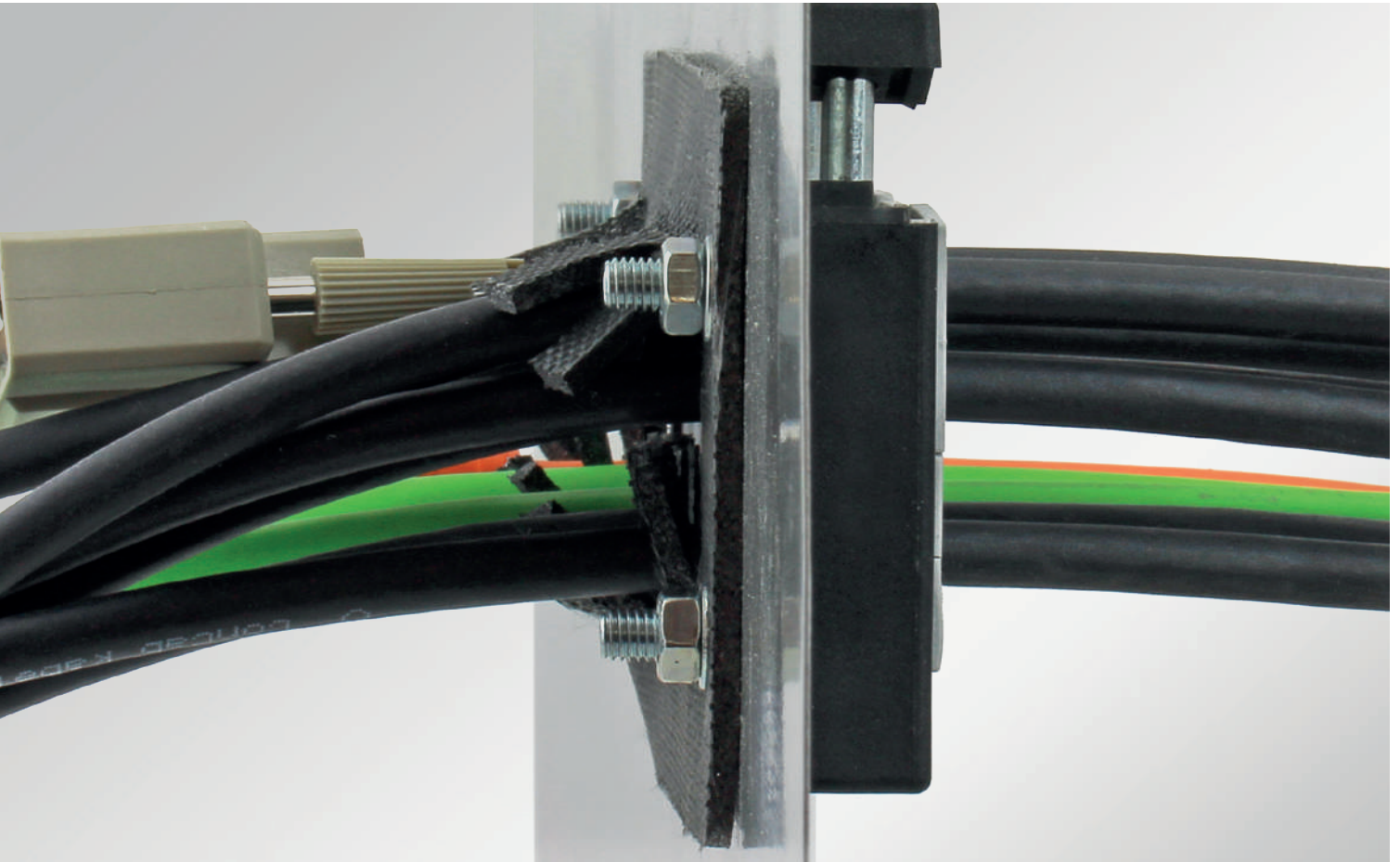



**STFZ I/O Insert Tool**  
Mounting tool for I/O modules

Description	Order No.	PU
STFZ I/O Insert Tool	61430	1

STFZ I/O Insert Tool for a quick and easy mounting of STFZ terminal clamps (EMC shield clamps for peripheral modules, see page 251).



 HL3 EN 45545-2	 E45 EI30 EN 45545-3	 JAPAN RAILWAY TESTED FLAME RETARDANT	 cRU	 IP68
 UL TYPE 12	 UL TYPE 4X	 RoHS compliant	 Made in Germany	 UV ISO 4892-2A



# Cable entry systems with IFPS fire penetration seals acc. to EN 45545-3

## Fire resistance of fire barriers

The European railway standard for fire safety EN 45545-3 regulates the fire resistance of fire barriers. The requirements and measures defined in this part of the standard aim to protect passengers and staff in railway vehicles against onboard fire incidents.

## Fire barriers can have different standards

### The lowest standard „E“

Barrier against flames, preventing fissure formation. „E45“, for example, means that the specimen can withstand the test for 45 minutes.



### The highest standard „EI“

Barrier against flames, preventing fissure formation and thermal insulation, which means that the temperature on the side facing away from the fire must not exceed 200° C (180° K above room temperature). „EI30“, for example, means that the specimen can withstand the test for 30 minutes.

Based on the standards EN 45545-3 and EN 1363-1 icotek cable entry systems have been tested on „E“ and „EI“ in vertical alignment using mounted IFPS fire penetration seals. All tested products have been successfully certified using only one layer of fire penetration seals.

### icotek cable entry systems meet the classifications E45 and EI30!

The cable entry frames and grommets manufactured by icotek have undergone flammability testing for railway vehicle materials by the Japan Railway Vehicle Machinery Engineering Association, and have been certified as "flame retardant".

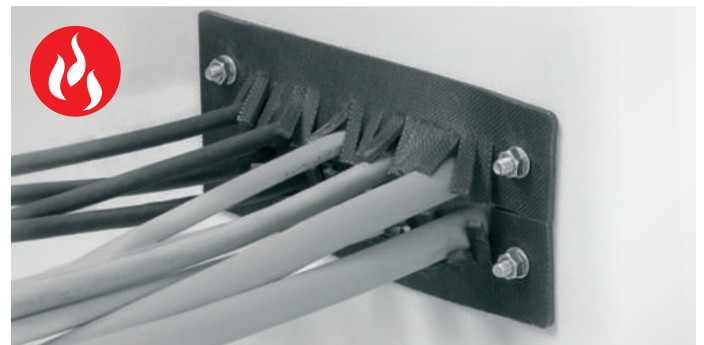

## Fire penetration seals facing the fire side



before



after

# Cable entry systems

## with IFPS fire penetration seals

### according to EN 45545-3



icotek cable entry frames and plates with fire penetration seals, approved for use in railway technology (meeting the standards EN 45545-2, EN 45545-3 and EN 1363-1).

The intumescent (foaming) IFPS fire penetration seals which are mounted at the backside of the cable entry components consist of expandable graphite and increase their volume by a multiple in case of a fire.

This creates a barrier which prevents a penetration of flames and high heat from one room into another for the longest possible period.

#### Advantages & benefits

- Approved for use in railway technology (EN 45545-2, EN 45545-3 and EN 1363-1)
- Easy assembly
- High cable density
- Only one fire penetration seal per cable entry component required
- Large product variety
- Up to IP66/UL Type 4X, depending on the cable entry
- High classifications E45/EI30

#### Specifications

Cable entry comp.	See standard products
Fire penetration seal	Intumescent (foaming)
Material	Graphite (C)

#### Scope of delivery

Each 1 cable entry frame/plate + suitable fire penetration seal.

**Suitable grommets are not included in the shipment and have to be ordered separately.**

Type	Order No.	Order No. with V2A screws	Cut-out	Grommets KT small   large	IP Ingress protection	PU
KEL-U 24 4-BS	99300.001	99300.201	36 × 112 mm	2 2	IP54	5
KEL-U 24 7-BS	99300.002	99300.202	36 × 112 mm	6 1	IP54	5
KEL-U 24 10-BS	99300.003	99300.203	36 × 112 mm	10 -	IP54	5
KEL-U 16 2-BS	99301.001	99301.201	36 × 86 mm	- 2	IP54	5
KEL-U 16 5-BS	99301.002	99301.202	36 × 86 mm	4 1	IP54	5
KEL-U 16 8-BS	99301.003	99301.203	36 × 86 mm	8 -	IP54	5
KEL-U 10 6-BS	99306.001	99306.201	36 × 65 mm	6 -	IP54	5
KEL-U 10 3-BS	99306.002	99306.202	36 × 65 mm	2 1	IP54	5
KEL-U-B1-BS	99305.001	99305.201	46 × 46 mm	- 1	IP54	5
KEL-U-B4-BS	99305.002	99305.202	46 × 46 mm	4 -	IP54	5
KEL-ER 24 4-BS	99300.004	99300.204	36 × 112 mm	2 2	IP65 / IP66	5
KEL-ER 24 7-BS	99300.005	99300.205	36 × 112 mm	6 1	IP65 / IP66	5
KEL-ER 24 10-BS	99300.006	99300.206	36 × 112 mm	10 -	IP65 / IP66	5
KEL-ER 16 2-BS	99301.004	99301.204	36 × 86 mm	- 2	IP65 / IP66	5
KEL-ER 16 5-BS	99301.005	99301.205	36 × 86 mm	4 1	IP65 / IP66	5
KEL-ER 16 8-BS	99301.006	99301.206	36 × 86 mm	8 -	IP65 / IP66	5
KEL-ER 10 6-BS	99306.003	99306.203	36 × 65 mm	6 -	IP65 / IP66	5
KEL-ER 10 3-BS	99306.004	99306.204	36 × 65 mm	2 1	IP65 / IP66	5
KEL-ER B1-BS	99305.003	99305.203	46 × 46 mm	- 1	IP65 / IP66	5
KEL-ER B4-BS	99305.004	99305.204	46 × 46 mm	4 -	IP65 / IP66	5
KEL-E5-BS	99302.001	99302.201	24 × 112 mm	5 -	IP54	5
KEL-E4-BS	99309.001	99309.201	24 × 86 mm	4 -	IP54	5
KEL-E3-BS	99308.001	99308.201	24 × 65 mm	3 -	IP54	5
KEL-E2-BS	99307.001	99307.201	24 × 43 mm	2 -	IP54	5
KEL-ER-E5-BS	99302.002	99302.202	24 × 112 mm	5 -	IP65 / IP66	5
KEL-ER-E4-BS	99309.002	99309.202	24 × 86 mm	4 -	IP65 / IP66	5
KEL-ER-E3-BS	99308.002	99308.202	24 × 65 mm	3 -	IP65 / IP66	5
KEL-ER-E2-BS	99307.002	99307.202	24 × 43 mm	2 -	IP65 / IP66	5

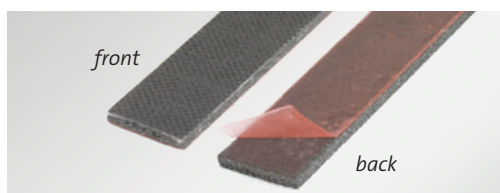

Also available: IFPS fire penetration seal stripe, 900 x 17 x 2.7 mm, self-adhesive  
Order No. 99303

# Cable entry systems

## with IFPS fire penetration seals

### according to EN 45545-3



icotek cable entry frames and plates with fire penetration seals, approved for use in railway technology (meeting the standards EN 45545-2, EN 45545-3 and EN 1363-1).

The intumescent (foaming) IFPS fire penetration seals which are mounted at the backside of the cable entry components consist of expandable graphite and increase their volume by a multiple in case of a fire.

This creates a barrier which prevents a penetration of flames and high heat from one room into another for the longest possible period.

#### Advantages & benefits

- Approved for use in railway technology (EN 45545-2, EN 45545-3 and EN 1363-1)
- Easy assembly
- High cable density
- Only one fire penetration seal per cable entry component required
- Large product variety
- Up to UL Type 4X/IP66, depending on the cable entry
- High classifications E45 / EI30

#### Specifications

Cable entry comp.	See standard products
Fire penetration seal	Intumescent (foaming)
Material	Graphite (C)

#### Scope of delivery

Each 1 cable entry frame/plate + suitable fire penetration seal.

Suitable grommets are not included in the shipment and have to be ordered separately.

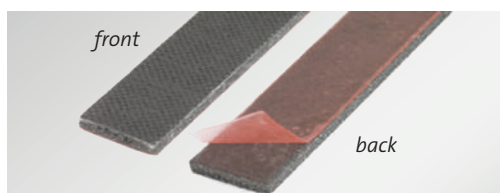

Also available: IFPS fire penetration seal stripe, 900 x 17 x 2.7 mm, self-adhesive  
Order No. 99303

Type	Order No.	Cut-out	IP Ingress protection	PU
KEL-DPU 24 13-BS gy	99300.010	36 × 112 mm	IP66 / IP68	5
KEL-DPU 24 14-BS gy	99300.011	36 × 112 mm	IP66 / IP68	5
KEL-DPU 24 16-BS gy	99300.012	36 × 112 mm	IP66 / IP68	5
KEL-DPU 24 16-1-BS gy	99300.013	36 × 112 mm	IP66 / IP68	5
KEL-DPU 24 17-BS gy	99300.014	36 × 112 mm	IP66 / IP68	5
KEL-DPU 24 20-BS gy	99300.015	36 × 112 mm	IP66 / IP68	5
KEL-DPU 24 21-BS gy	99300.016	36 × 112 mm	IP66 / IP68	5
KEL-DPU 24 32-BS gy	99300.017	36 × 112 mm	IP66 / IP68	5
KEL-DPZ 16 11-BS gy	99301.007	36 × 86 mm	IP65 / IP66	5
KEL-DPZ 16 14-BS gy	99301.008	36 × 86 mm	IP65 / IP66	5
KEL-DPZ 16 20-BS gy	99301.009	36 × 86 mm	IP65 / IP66	5
KEL-DPZ 16 25-BS gy	99301.010	36 × 86 mm	IP65 / IP66	5
KEL-DPZ 16 34-BS gy	99301.011	36 × 86 mm	IP65 / IP66	5
KEL-DPZ 24 14-BS gy	99300.018	36 × 112 mm	IP65 / IP66	5
KEL-DPZ 24 15-BS gy	99300.019	36 × 112 mm	IP65 / IP66	5
KEL-DPZ 24 16-BS gy	99300.020	36 × 112 mm	IP65 / IP66	5
KEL-DPZ 24 17-BS gy	99300.021	36 × 112 mm	IP65 / IP66	5
KEL-DPZ 24 25-BS gy	99300.022	36 × 112 mm	IP65 / IP66	5
KEL-DPZ 24 32-BS gy	99300.023	36 × 112 mm	IP65 / IP66	5
KEL-DPZ 24 42-BS gy	99300.024	36 × 112 mm	IP65 / IP66	5

#### Fire penetration seal (accessories)

Type	Order No.	Cut-out	PU
Fire penetration seal size 24	99300	36 × 112 mm	1
Fire penetration seal size 16	99301	36 × 86 mm	1
Fire penetration seal size 10	99306	36 × 65 mm	1
Fire penetration seal size B	99305	46 × 46 mm	1
Fire penetration seal size E5	99302	24 × 112 mm	1
Fire penetration seal size E4	99309	24 × 86 mm	1
Fire penetration seal size E3	99308	24 × 65 mm	1
Fire penetration seal size E2	99307	24 × 43 mm	1
Fire penetration seal size KEL 183 **	99311	180 × 80 mm	1
Fire penetration seal size 24-MT **	99312	82 × 112 mm	1
Fire penetration seal size 16-MT **	99314	82 × 86 mm	1
Fire penetration seal for KEL-DPZ-KX/KL72 **	99315	62 × 192 mm	1

\*\* At the time of certification, these sizes were not yet part of our product portfolio.

\*4X for indoor use only



# Cable entry systems for the use in cleanrooms

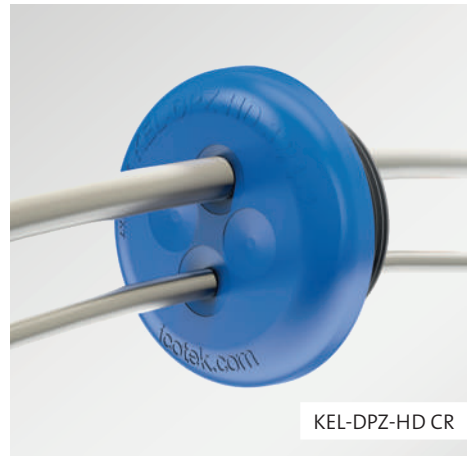
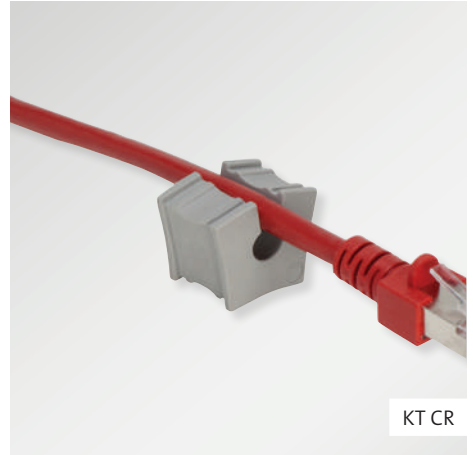

## 10 Cable entry systems for the use in cleanrooms



**A cleanroom is a room that has an extremely low concentration of airborne particles. Airborne particles are all particles and substances that are suspended in the air and for the most part cannot be seen with the naked eye.**

Such cleanrooms are needed wherever particles present in the ambient air would disrupt production. This is the case, for example, in medical technology, semiconductor production, microsystems technology, pharmaceuticals, aerospace technology or optics. Cleanrooms are also needed in medical research.

Cleanrooms are classified by classes according to ISO 14644-1 as per ISO 1 to 9. The individual cleanroom classes may only contain a certain number of particles of a specified size. The particle concentration is considered per m<sup>3</sup> of air. ISO 1 contains the strictest specifications, for ISO 9 the lowest specifications.

In order to meet these strict requirements, materials specially researched or modified by icotek are required and used for the certified cleanroom products.

**All icotek cable entry systems for the cleanroom tested and certified by the Fraunhofer IPA are suitable and certified for class 1 in accordance with ISO 14644-1.**



For more information about products for the cleanroom, please contact us directly: [pm@icotek.com](mailto:pm@icotek.com)



## Cleanroom classes according to ISO 14644-1 and other regulations

Regulatory				Limiting values of each air cleanliness class for differing particle sizes and reference volumes (acc. to ISO 14644-1)											
EG-GMP *in operation *	EG-GMP *at rest*	US Fed. Standard 209E*	DIN EN ISO 14644-1	0.1 µm		0.2 µm		0.3 µm		0.5 µm		1.0 µm		5.0 µm	
				per m³	per cbf	per m³	per cbf	per m³	per cbf	per m³	per cbf	per m³	per cbf	per m³	per cbf
			1	10	0,3										
			2	100	3	24	1	10	0,3						
			3	1.000	30	237	7	102	3	35	1				
		1		1.240	35	265	8	106	3	35	1				
		10	4	10.000	300	2.370	67	1.020	29	352	9,9	83	2		
				12.000	340	2.650	75	1.060	29	353	10				
A	A B	100	5	100.000	2.833	23.700	671	10.200	289	3.520	100	832	24	29	0,8
										3.520	100			20	0,6
										3.520	100			20	0,6
										3.520	100			29	0,8
						26.500	750	10.600	300	3.530	100				
		1.000	6	1.000.000	28.329	237.000	6.710	102.000	2.890	35.200	997	8.320	235	293	8
										35.300	1.000			247	7
B	C	10.000	7							352.000	9.972	83.200	2.357	2.930	83
										352.000	9.972			2.900	82
										352.000	9.972			2.900	82
										353.000	10.000			2.470	70
C	D	100.000	8							3.520.000	99.716	832.000	23.569	29.300	830
										3.520.000	99.716			29.000	821
										3.520.000	99.716			29.000	821
										3.530.000	100.000			24.700	700
			9							35.200.000	997.167	8.320.000	235.694	293.000	8.300

Source: Fraunhofer IPA

## Industries and cleanliness criteria

	Particle emission	Outgassing VOC / SVOC	Outgassing anions	Outgassing NH <sub>3</sub>	ESD	Cleanability (Riboflavin test)	Chemical resistance	Biological resistance	Antibacterial activity	H <sub>2</sub> O <sub>2</sub> absorption/ desorption	Hygienic Design
Semiconductor industry	++	++	+	+	++	+	+	+	0	0	0
Electronic	++	+	+	+	++	0	0	0	0	0	0
Display (e.g. mobile phone)	++	+	0	0	++	0	0	0	0	0	0
Battery technology	++	0	0	0	++	0	0	0	0	0	0
Microsystem technology	++	+	0	0	++	+	+	+	0	0	0
Optic	+	++	+	+	+	+	+	+	0	0	0
Photovoltaic	+	+	0	0	+	0	0	0	0	0	0
Aerospace	++	++	+	+	++	+	+	+	+	0	0
Pharmacy	++	0	0	0	+	++	++	++	++	++	++
Biotechnology	+	+	0	0	0	++	++	++	++	+	++
Medical technology	+	0	0	0	+	++	++	++	++	+	++
Food technology	+	0	0	0	0	++	++	++	++	+	++
Hospital	0	0	0	0	0	++	++	++	++*)	+	++

\*) depending on the subject

++ mandatory | + recommended, but not mandatory | 0 generally not required but in individual cases recommended

Source: Fraunhofer IPA

\*4X for indoor use only

## 10 Cable entry systems for the use in cleanrooms

### Specially designed for the cleanroom

Not only the particle emissions are relevant but also the outgassing values VOC (Volatile Organic Compounds)/SVOC (Semivolatile Organic Compounds) of the products used in clean rooms. This applies in particular to the semiconductor, optics and aerospace industries.

In the ISO class, the air cleanliness classification works on the basis of the particulate concentration.

In the ISO-ACC class, air cleanliness works on the basis of chemical concentration. The chemical concentration can lead to a chemical contamination, which can have a damaging effect on the product or on the process.

Materials as well as cable entry systems are classified based on their chemical concentration.



#### **i** Decontamination with H<sub>2</sub>O<sub>2</sub> vaporization

Cleanrooms must be cleaned of contamination with microorganisms, particles and pyrogens before each commissioning or after maintenance work. An effective method is cleaning by vaporizing hydrogen peroxide (H<sub>2</sub>O<sub>2</sub>). The hydrogen peroxide is converted into a gaseous state and the subsequent microcondensation results in optimum decontamination throughout the entire room and on all surfaces.

icotek has subjected its cable entry systems to the H<sub>2</sub>O<sub>2</sub> cleaning process and can recommend its use. A declaration of conformity is available on request from product management: pm@icotek.com

#### **Manual disinfection**

icotek recommends cleaning products installed in cleanrooms with a mixture of 70% isopropanol and 30% distilled water.

**ISO-ACCe Class (x) =**  
**ISO-Air Cleanliness chemical concentration for equipment =**  
**AMC Class Equipment**

**ISO-ACCm Class (x) =**  
**ISO-Air Cleanliness chemical concentration for material =**  
**AMC Class Material**

The Fraunhofer IPA certified values that were in part no longer measurable in the ultra-trace range and thus excellent to very good values. The material-specific emission rate (= ISO-ACCm class) was determined. The smaller the ISO-ACCm class, the lower the material-specific emission rate.

The test certificates of the Fraunhofer IPA can be requested from icotek: pm@icotek.com



#### **i** Explanation of article numbers

The products with article ending **.600** are tested and certified for particle emission for cleanroom class 1 according to ISO 14644-1. The materials used for these products have been tested and certified for outgassing according to VOC/SVOC (ISO 14644-8; ISO 16000-6,-9,-11,-25, VDI 2083 sheet 17).

The products with the article ending **.601** are tested and certified for particle emission for cleanroom class 1 according to ISO 14644-1.





EN ISO 14644



Split cable entry system  
for cables with connectors

KEL-ER CR series

IP66

402



Split cable entry system  
for cables with connectors

KEL-U CR series

IP54

403

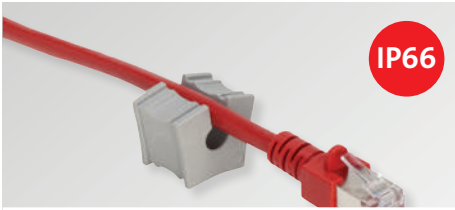

Grommets  
small, single

KT CR

IP66

404



Grommets  
small, multi

KT CR

IP68

405

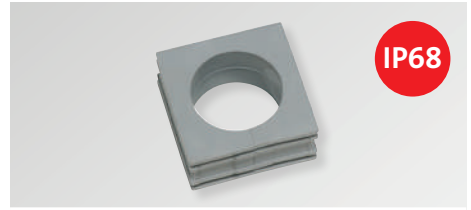

Grommets  
large

KT CR

IP68

406



Cable entry plates

KEL-DPZ CR series

IP66

407 – 409



Cable entry plates

KEL-DPZ round CR series

IP68

410



Cable entry plates  
*Hygienic Design Line*

KEL-DPZ-HD CR

IP68

411

# Cable entry frames

## KEL-ER CR series



Split cable entry system for cables with connectors.  
Detailed product description from page 10.

Type	Cut-out mm	Grommets KT small   large	Order No. *	Order No. **	PU
<b>KEL-ER 24 CR</b>					
KEL-ER 24 10 CR	36/46 × 112	10   –	48241.600	48241.601	5
KEL-ER 24 7 CR	36/46 × 112	6   1	48247.600	48247.601	5
KEL-ER 24 4 CR	36/46 × 112	2   2	48244.600	48244.601	5
<b>KEL-ER 16 CR</b>					
KEL-ER 16 8 CR	36/46 × 86	8   –	48168.600	48168.601	5
KEL-ER 16 5 CR	36/46 × 86	4   1	48165.600	48165.601	5
KEL-ER 16 2 CR	36/46 × 86	–   2	48162.600	48162.601	5
<b>KEL-ER 10 CR</b>					
KEL-ER 10 6 CR	36/46 × 65	6   –	48216.600	48216.601	5
KEL-ER 10 3 CR	36/46 × 65	2   1	48212.600	48212.601	5
<b>KEL-ER-B CR</b>					
KEL-ER-B4 CR	46 × 46	4   –	48204.600	48204.601	5
KEL-ER-B1 CR	46 × 46	–   1	48206.600	48206.601	5
<b>KEL-ER-E CR</b>					
KEL-ER-E5 CR	112 × 24	5   –	48250.600	48250.601	5
KEL-ER-E4 CR	112 × 24	4   –	48259.600	48259.601	5
KEL-ER-E3 CR	65 × 24	3   –	48258.600	48258.601	5
KEL-ER-E2 CR	43 × 24	2   –	48249.600	48249.601	5

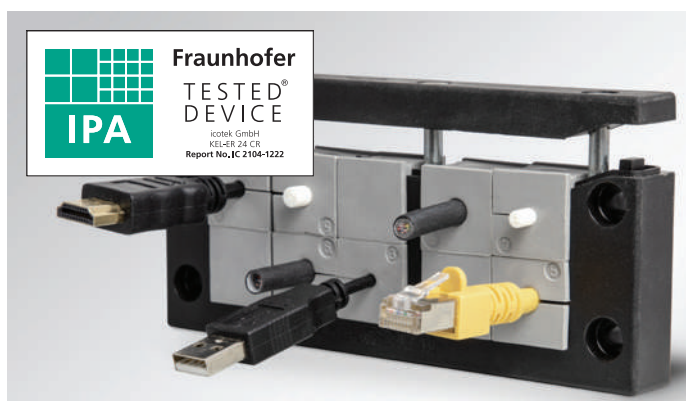

- \* The products with article ending .600 are tested and certified for particle emission for cleanroom class 1 according to ISO 14644-1. The materials used for these products have been tested and certified for outgassing according to VOC/SVOC (ISO 14644-8; ISO 16000-6,-9,-11,-25, VDI 2083 sheet 17).
- \*\* The products with the article ending .601 are tested and certified for particle emission for cleanroom class 1 according to ISO 14644-1.

# Cable entry frames

## KEL-U CR series



Split cable entry system for cables with connectors.  
Detailed product description from page 10.

Type	Cut-out mm	Grommets KT small   large	Order No. *	Order No. **	PU
<b>KEL-U 24 CR</b>					
KEL-U 24 10 CR	36/46 × 112	10   –	54241.600	54241.601	5
KEL-U 24 7 CR	36/46 × 112	6   1	54247.600	54247.601	5
KEL-U 24 4 CR	36/46 × 112	2   2	54244.600	54244.601	5
<b>KEL-U 16 CR</b>					
KEL-U 16 8 CR	36/46 × 86	8   –	54168.600	54168.601	5
KEL-U 16 5 CR	36/46 × 86	4   1	54165.600	54165.601	5
KEL-U 16 2 CR	36/46 × 86	–   2	54162.600	54162.601	5
<b>KEL-U 10 CR</b>					
KEL-U 10 6 CR	36/46 × 65	6   –	54216.600	54216.601	5
KEL-U 10 3 CR	36/46 × 65	2   1	54212.600	54212.601	5
<b>KEL-U-B CR</b>					
KEL-U-B4 CR	46 × 46	4   –	54204.600	54204.601	5
KEL-U-B1 CR	46 × 46	–   1	54206.600	54206.601	5



- \* The products with article ending .600 are tested and certified for particle emission for cleanroom class 1 according to ISO 14644-1. The materials used for these products have been tested and certified for outgassing according to VOC/SVOC (ISO 14644-8; ISO 16000-6,-9,-11,-25, VDI 2083 sheet 17).
- \*\* The products with the article ending .601 are tested and certified for particle emission for cleanroom class 1 according to ISO 14644-1.

# KT CR

## Grommets, small, single

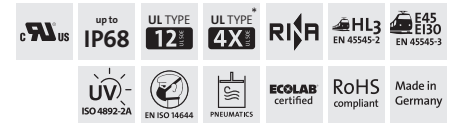

Detailed product description from page 76.

Description	Type	Clamping range	Order No. * grey	Order No. ** grey	PU
BTK	BTK CR	Blank grommet	■ 41251.600	■ 41251.601	10
KT small	KT 1 CR	1 – 2 mm	■ 39941.600	■ 39941.601	10
	KT 2 CR	2 – 3 mm	■ 39934.600	■ 39934.601	10
	KT 3 CR	3 – 4 mm	■ 41203.600	■ 41203.601	10
	KT 4 CR	4 – 5 mm	■ 41204.600	■ 41204.601	10
	KT 5 CR	5 – 6 mm	■ 41205.600	■ 41205.601	10
	KT 6 CR	6 – 7 mm	■ 41206.600	■ 41206.601	10
	KT 7 CR	7 – 8 mm	■ 41207.600	■ 41207.601	10
	KT 8 CR	8 – 9 mm	■ 41208.600	■ 41208.601	10
	KT 9 CR	9 – 10 mm	■ 41209.600	■ 41209.601	10
	KT 10 CR	10 – 11 mm	■ 41210.600	■ 41210.601	10
	KT 11 CR	11 – 12 mm	■ 41211.600	■ 41211.601	10
	KT 12 CR	12 – 13 mm	■ 41212.600	■ 41212.601	10
	KT 13 CR	13 – 14 mm	■ 41213.600	■ 41213.601	10
	KT 14 CR	14 – 15 mm	■ 41214.600	■ 41214.601	10
	KT 15 CR	15 – 16 mm	■ 41215.600	■ 41215.601	10
	KTs 16 CR	16 mm	■ 39901.600	■ 39901.601	10
	KTs 17 CR	17 mm	■ 39900.600	■ 39900.601	10

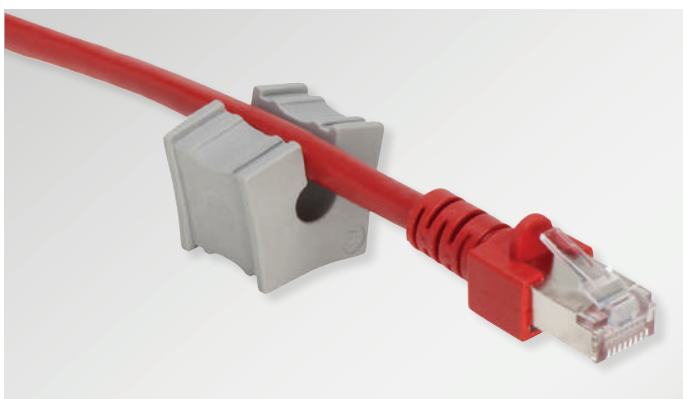

- \* The products with article ending .600 are tested and certified for particle emission for cleanroom class 1 according to ISO 14644-1. The materials used for these products have been tested and certified for outgassing according to VOC/SVOC (ISO 14644-8; ISO 16000-6,-9,-11,-25, VDI 2083 sheet 17).
- \*\* The products with the article ending .601 are tested and certified for particle emission for cleanroom class 1 according to ISO 14644-1.



The cable grommets CR are each certified in connection with the cable entry frames KEL-ER CR and KEL-U CR.

# KT CR

## Grommets, small, multi



Detailed product description from page 80.

Description	Type	Clamping range	Order No. * grey	Order No. ** grey	PU
KT 2 x	KT 2 1 CR	2× ø 1 mm	■ 39942.600	■ 39942.601	10
	KT 2 2 CR	2× ø 2 mm	■ 39935.600	■ 39935.601	10
	KT 2 3 CR	2× ø 3 mm	■ 39939.600	■ 39939.601	10
	KT 2 4 CR	2× ø 4 mm	■ 39906.600	■ 39906.601	10
	KT 2 5 CR	2× ø 5 mm	■ 41200.600	■ 41200.601	10
	KT 2 6 CR	2× ø 6 mm	■ 41201.600	■ 41201.601	10
	KT 2 7 CR	2× ø 7 mm	■ 41202.600	■ 41202.601	10
	KT 2 8 CR	2× ø 8 mm	■ 39917.600	■ 39917.601	10
KT 4 x	KT 4 2 CR	4× ø 2 mm	■ 39937.600	■ 39937.601	10
	KT 4 3 CR	4× ø 3 mm	■ 39914.600	■ 39914.601	10
	KT 4 4 CR	4× ø 4 mm	■ 39909.600	■ 39909.601	10
	KT 4 5 CR	4× ø 5 mm	■ 39908.600	■ 39908.601	10
	KT 4 6 CR	4× ø 6 mm	■ 39932.600	■ 39932.601	10



- \* The products with article ending .600 are tested and certified for particle emission for cleanroom class 1 according to ISO 14644-1. The materials used for these products have been tested and certified for outgassing according to VOC/SVOC (ISO 14644-8; ISO 16000-6,-9,-11,-25, VDI 2083 sheet 17).
- \*\* The products with the article ending .601 are tested and certified for particle emission for cleanroom class 1 according to ISO 14644-1.



The cable grommets CR are each certified in connection with the cable entry frames KEL-ER CR and KEL-U CR.

10

# KT CR

## Grommets, large

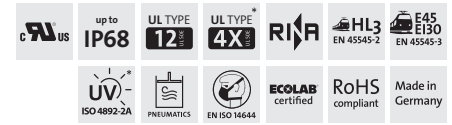

Detailed product description from page 77.

Description	Type	Clamping range	Order No. * grey	Order No. ** grey	PU
ATG	ATG CR	Adapter grommet	41253.600	41253.601	10
BTG	BTG CR	Blank grommet	41252.600	41252.601	10
KT large	KTG 13 CR	13 – 14 mm	41263.600	41263.601	10
	KTG 14 CR	14 – 15 mm	41264.600	41264.601	10
	KTG 15 CR	15 – 16 mm	41265.600	41265.601	10
	KT 16 CR	16 – 17 mm	41216.600	41216.601	10
	KT 17 CR	17 – 18 mm	41217.600	41217.601	10
	KT 18 CR	18 – 19 mm	41218.600	41218.601	10
	KT 19 CR	19 – 20 mm	41219.600	41219.601	10
	KT 20 CR	20 – 21 mm	41220.600	41220.601	10
	KT 21 CR	21 – 22 mm	41221.600	41221.601	10
	KT 22 CR	22 – 23 mm	41222.600	41222.601	10
	KT 23 CR	23 – 24 mm	41223.600	41223.601	10
	KT 24 CR	24 – 25 mm	41224.600	41224.601	10
	KT 25 CR	25 – 26 mm	41225.600	41225.601	10
	KT 26 CR	26 – 27 mm	41226.600	41226.601	10
	KT 27 CR	27 – 28 mm	41227.600	41227.601	10
	KT 28 CR	28 – 29 mm	41228.600	41228.601	10
KT 29 CR	29 – 30 mm	41229.600	41229.601	10	
KT 30 CR	30 – 31 mm	41230.600	41230.601	10	
KT 31 CR	31 – 32 mm	41231.600	41231.601	10	
KT 32 CR	32 – 33 mm	41232.600	41232.601	10	
KT 33 CR	33 – 34 mm	41233.600	41233.601	10	
KT 34 CR	34 – 35 mm	41234.600	41234.601	10	

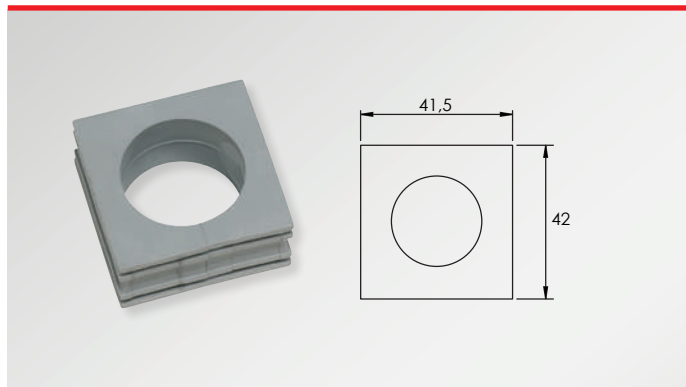

\* The products with article ending .600 are tested and certified for particle emission for cleanroom class 1 according to ISO 14644-1. The materials used for these products have been tested and certified for outgassing according to VOC/SVOC (ISO 14644-8; ISO 16000-6,-9,-11,-25, VDI 2083 sheet 17).

\*\* The products with the article ending .601 are tested and certified for particle emission for cleanroom class 1 according to ISO 14644-1.



The cable grommets CR are each certified in connection with the cable entry frames KEL-ER CR and KEL-U CR.

# Cable entry plates KEL-DPZ CR series



Detailed product description from page 140.

Type	Cut-out mm	Number of cables	Order No. *	Order No. **	PU
<b>KEL-DPZ 24 CR</b>					
KEL-DPZ 24 14 CR	36 x 112 mm	10× 3.2 - 6.5 mm 4× 16 - 22 mm	■ 43700.600 ■ 50700.600	■ 43700.601 ■ 50700.601	5
KEL-DPZ 24 15 CR	36 x 112 mm	15× 7.2 - 12 mm	■ 43720.600 ■ 50720.600	■ 43720.601 ■ 50720.601	5
KEL-DPZ 24 16 CR	36 x 112 mm	8× 3.2 - 6.5 mm 4× 5 - 9.7 mm 2× 9 - 16.2 mm 2× 16 - 22 mm	■ 43725.600 ■ 50725.600	■ 43725.601 ■ 50725.601	5
KEL-DPZ 24 17 CR	36 x 112 mm	6× 3.2 - 6.5 mm 6× 5 - 10.2 mm 5× 9 - 16.2 mm	■ 43705.600 ■ 50705.600	■ 43705.601 ■ 50705.601	5
KEL-DPZ 24 25 CR	36 x 112 mm	12× 3.2 - 6.5 mm 7× 4.8 - 9.7 mm 6× 7.5 - 12 mm	■ 43710.600 ■ 50710.600	■ 43710.601 ■ 50710.601	5
KEL-DPZ 24 26 CR	36 x 112 mm	26× 5.0 - 10.2 mm	■ 43711.600 ■ 50711.600	■ 43711.601 ■ 50711.601	5
KEL-DPZ 24 32 CR	36 x 112 mm	21× 3.2 - 6.5 mm 8× 5 - 10.2 mm 3× 7.5 - 12 mm	■ 43730.600 ■ 50730.600	■ 43730.601 ■ 50730.601	5
KEL-DPZ 24 42 CR	36 x 112 mm	42× 3.2 - 6.5 mm	■ 43715.600 ■ 50715.600	■ 43715.601 ■ 50715.601	5
KEL-DPZ 24 121 CR	36 x 112 mm	119× 1.5 - 2.6 mm 2× 2.5 - 5 mm	■ 43735.600 ■ 50735.600	■ 43735.601 ■ 50735.601	5



\* The products with article ending .600 are tested and certified for particle emission for cleanroom class 1 according to ISO 14644-1. The materials used for these products have been tested and certified for outgassing according to VOC/SVOC (ISO 14644-8; ISO 16000-6,-9,-11,-25, VDI 2083 sheet 17).

\*\* The products with the article ending .601 are tested and certified for particle emission for cleanroom class 1 according to ISO 14644-1.

# Cable entry plates KEL-DPZ CR series



Detailed product description from page 140.

Type	Cut-out mm	Number of cables	Order No. *	Order No. **	PU
<b>KEL-DPZ 16 CR</b>					
KEL-DPZ 16 11 CR	36 x 86 mm	11 x 7.5 - 12 mm	43815.600	43815.601	5
KEL-DPZ 16 14 CR	36 x 86 mm	5 x 3.2 - 6.5 mm 5 x 5 - 10.2 mm 4 x 9 - 16.2 mm	43816.600	43816.601	5
KEL-DPZ 16 20 CR	36 x 86 mm	11 x 3.2 - 6.5 mm 5 x 5 - 10.2 mm 4 x 7.5 - 12 mm	43817.600	43817.601	5
KEL-DPZ 16 25 CR	36 x 86 mm	16 x 3.2 - 6.5 mm 6 x 5 - 10.2 mm 3 x 7.5 - 12 mm	43818.600	43818.601	5
KEL-DPZ 16 34 CR	36 x 86 mm	34 x 3.2 - 6.5 mm	43819.600	43819.601	5
<b>KEL-DPZ 6 CR</b>					
KEL-DPZ 6 12 CR	52 x 36 mm	12 x 4.5 - 8.0 mm	43809.600	43809.601	5
KEL-DPZ 6 18-1 CR	52 x 36 mm	6 x 2.5 - 5.0 mm 5 x 3.2 - 6.5 mm 7 x 4.5 - 8.0 mm	43811.600	43811.601	5
KEL-DPZ 6 18 CR	52 x 36 mm	18 x 3.2 - 6.5 mm	43812.600	43812.601	5
KEL-DPZ 6 23 CR	52 x 36 mm	13 x 2.5 - 5.0 mm 10 x 3.2 - 6.5 mm	43813.600	43813.601	5
KEL-DPZ 6 27 CR	52 x 36 mm	27 x 2.5 - 5.0 mm	43814.600	43814.601	5



- \* The products with article ending .600 are tested and certified for particle emission for cleanroom class 1 according to ISO 14644-1. The materials used for these products have been tested and certified for outgassing according to VOC/SVOC (ISO 14644-8; ISO 16000-6,-9,-11,-25, VDI 2083 sheet 17).
- \*\* The products with the article ending .601 are tested and certified for particle emission for cleanroom class 1 according to ISO 14644-1.



# Cable entry plates KEL-DPZ CR series



Detailed product description from page 140.

Type	Cut-out mm	Number of cables	Order No. *	Order No. **	PU
<b>KEL-DPZ-B CR</b>					
KEL-DPZ-B 13 CR	46 x 46 mm	8× 3.2 - 6.5 mm 4× 5 - 10.2 mm 1× 16 - 22 mm	■ 43794.600 ■ 50794.600	■ 43794.601 ■ 50794.601	5
KEL-DPZ-B 17 CR	46 x 46 mm	10× 3.2 - 6.5 mm 4× 5 - 10.2 mm 2× 7.5 - 12 mm 1× 9 - 16.2 mm	■ 43796.600 ■ 50796.600	■ 43796.601 ■ 50796.601	5
KEL-DPZ-B 25 CR	46 x 46 mm	25× 3.2 - 6.5 mm	■ 43798.600 ■ 50798.600	■ 43798.601 ■ 50798.601	5
<b>KEL-DPZ-E CR</b>					
KEL-DPZ-E 112 7 CR	18 x 112 mm	7× 7.5 - 12 mm	■ 43780.600 ■ 50780.600	■ 43780.601 ■ 50780.601	5
KEL-DPZ-E 112 21 CR	18 x 112 mm	21× 3.2 - 6.5 mm	■ 43790.600 ■ 50790.600	■ 43790.601 ■ 50790.601	5
<b>KEL-DPZ-KX/KL CR</b>					
KEL-DPZ-KX/KL 72 CR	62 x 192 mm	42× 3.2 - 6.5 mm 21× 5 - 10.2 mm 6× 9 - 16.2 mm 3× 16 - 22 mm	■ 43675.001.600 ■ 43675.101.600	■ 43675.001.601 ■ 43675.101.601	1

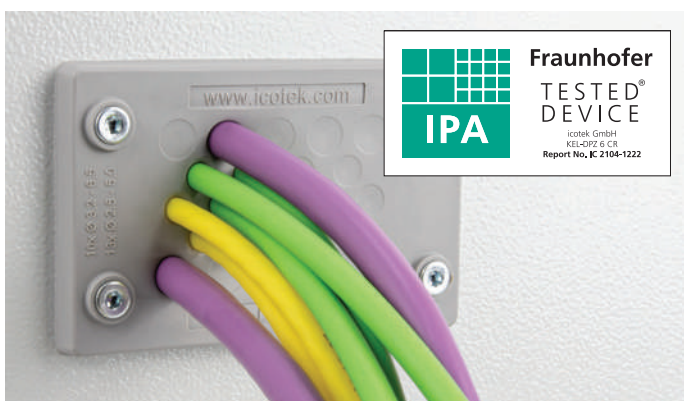

- \* The products with article ending .600 are tested and certified for particle emission for cleanroom class 1 according to ISO 14644-1. The materials used for these products have been tested and certified for outgassing according to VOC/SVOC (ISO 14644-8; ISO 16000-6,-9,-11,-25, VDI 2083 sheet 17).
- \*\* The products with the article ending .601 are tested and certified for particle emission for cleanroom class 1 according to ISO 14644-1.

# Cable entry plates

## KEL-DPZ round CR series

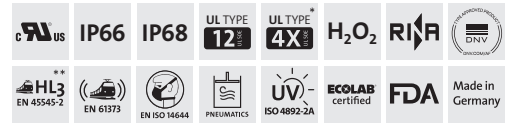

Detailed product description from page 156.

Type	Number of cables	Thread metric	Thread length	External diameter	Mounting height	Order No. *	Order No. **	PU
KEL-DPZ 25 3 CR	2× 3.2 - 5.2 mm 1× 3.2 - 6.5 mm	M25 × 1.5	14 mm	39 mm	8 mm	■ 43736.600 ■ 50736.600	■ 43736.601 ■ 50736.601	5
KEL-DPZ 25 4 CR	4× 3.2 - 5.2 mm	M25 × 1.5	14 mm	39 mm	8 mm	■ 43737.600 ■ 50737.600	■ 43737.601 ■ 50737.601	5
KEL-DPZ 32 4 CR	3× 3.2 - 6.5 mm 1× 7.2 - 12.5 mm	M32 × 1.5	14 mm	44 mm	8 mm	■ 43732.600 ■ 50732.600	■ 43732.601 ■ 50732.601	5
KEL-DPZ 32 4-2 CR	4× 5 - 9.5 mm	M32 × 1.5	14 mm	44 mm	8 mm	■ 43733.600 ■ 50733.600	■ 43733.601 ■ 50733.601	5
KEL-DPZ 32 7 CR	7× 3.2 - 6.5 mm	M32 × 1.5	14 mm	44 mm	8 mm	■ 43734.600 ■ 50734.600	■ 43734.601 ■ 50734.601	5
KEL-DPZ 40 8 CR	4× 3.2 - 6.5 mm 4× 5 - 10.2 mm	M40 × 1.5	14 mm	52 mm	8 mm	■ 43741.600 ■ 50741.600	■ 43741.601 ■ 50741.601	5
KEL-DPZ 50 8 CR	5× 5 - 10.2 mm 3× 7.2 - 12.5 mm	M50 × 1.5	14 mm	62 mm	8 mm	■ 43750.600 ■ 50750.600	■ 43750.601 ■ 50750.601	5
KEL-DPZ 50 10 CR	7× 3.2 - 6.5 mm 2× 5 - 10.2 mm 1× 16 - 22.2 mm	M50 × 1.5	14 mm	62 mm	8 mm	■ 43751.600 ■ 50751.600	■ 43751.601 ■ 50751.601	5
KEL-DPZ 50 12 CR	4× 3.2 - 6.5 mm 8× 5 - 10.2 mm	M50 × 1.5	14 mm	62 mm	8 mm	■ 43752.600 ■ 50752.600	■ 43752.601 ■ 50752.601	5
KEL-DPZ 50 19 CR	19× 3.2 - 6.5 mm	M50 × 1.5	14 mm	62 mm	8 mm	■ 43758.600 ■ 50758.600	■ 43758.601 ■ 50758.601	5
KEL-DPZ 50 78 CR	76× 1.5 - 2.6 mm 2× 2.5 - 5 mm	M50 × 1.5	14 mm	62 mm	8 mm	■ 43756.600 ■ 50756.600	■ 43756.601 ■ 50756.601	5
KEL-DPZ 63 9 CR	1× 3.2 - 6.5 mm 3× 5 - 10.2 mm 4× 9 - 16.2 mm 1× 16 - 22.2 mm	M63 × 1.5	14 mm	75 mm	8 mm	■ 43760.600 ■ 50760.600	■ 43760.601 ■ 50760.601	5
KEL-DPZ 63 13 CR	4× 3.2 - 6.5 mm 4× 5 - 10.2 mm 5× 9 - 16.2 mm	M63 × 1.5	14 mm	75 mm	8 mm	■ 43761.600 ■ 50761.600	■ 43761.601 ■ 50761.601	5
KEL-DPZ 63 14 CR	14× 5 - 10.2 mm	M63 × 1.5	14 mm	75 mm	8 mm	■ 43762.600 ■ 50762.600	■ 43762.601 ■ 50762.601	5
KEL-DPZ 63 35 CR	35× 3.2 - 6.5 mm	M63 × 1.5	14 mm	75 mm	8 mm	■ 43763.600 ■ 50763.600	■ 43763.601 ■ 50763.601	5

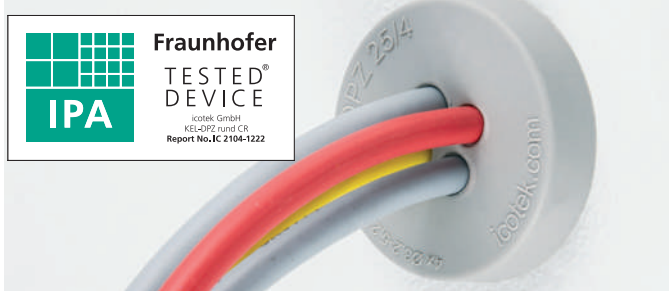

\* The products with article ending .600 are tested and certified for particle emission for cleanroom class 1 according to ISO 14644-1. The materials used for these products have been tested and certified for outgassing according to VOC/SVOC (ISO 14644-8; ISO 16000-6,-9,-11,-25, VDI 2083 sheet 17).

\*\* The products with the article ending .601 are tested and certified for particle emission for cleanroom class 1 according to ISO 14644-1.

# Cable entry plates

## KEL-DPZ-HD CR

Hygienic Design Line



Detailed product description from page 428.

Type	Number of cables	Thread metric	Thread length	External diameter	Mounting height	Order No. *	Order No. **	PU
KEL-DPZ-HD 32 4 CR	3× 3.2 - 6.5 mm 1× 7.2 - 12.5 mm	M32 × 1.5	14 mm	44 mm	8 mm	70351.600	70351.601	5
KEL-DPZ-HD 32 4-2 CR	4× 5 - 9.5 mm	M32 × 1.5	14 mm	44 mm	8 mm	70352.600	70352.601	5
KEL-DPZ-HD 32 7 CR	7× 3.2 - 6.5 mm	M32 × 1.5	14 mm	44 mm	8 mm	70353.600	70353.601	5
KEL-DPZ-HD 40 8 CR	4× 3.2 - 6.5 mm 4× 5 - 10.2 mm	M40 × 1.5	14 mm	52 mm	8 mm	70354.600	70354.601	5
KEL-DPZ-HD 50 8 CR	5× 5 - 10.2 mm 3× 7.2 - 12.5 mm	M50 × 1.5	14 mm	62 mm	8 mm	70355.600	70355.601	5
KEL-DPZ-HD 50 10 CR	7× 3.2 - 6.5 mm 2× 5 - 10.2 mm 1× 16 - 22.2 mm	M50 × 1.5	14 mm	62 mm	8 mm	70356.600	70356.601	5
KEL-DPZ-HD 50 12 CR	4× 3.2 - 6.5 mm 8× 5 - 10.2 mm	M50 × 1.5	14 mm	62 mm	8 mm	70357.600	70357.601	5
KEL-DPZ-HD 50 19 CR	19× 3.2 - 6.5 mm	M50 × 1.5	14 mm	62 mm	8 mm	70358.600	70358.601	5
KEL-DPZ-HD 63 9 CR	1× 3.2 - 6.5 mm 3× 5 - 10.2 mm 4× 9 - 16.2 mm 1× 16 - 22.2 mm	M63 × 1.5	14 mm	75 mm	8 mm	70359.600	70359.601	5
KEL-DPZ-HD 63 13 CR	4× 3.2 - 6.5 mm 4× 5 - 10.2 mm 5× 9 - 16.2 mm	M63 × 1.5	14 mm	75 mm	8 mm	70360.600	70360.601	5
KEL-DPZ-HD 63 14 CR	14× 5 - 10.2 mm	M63 × 1.5	14 mm	75 mm	8 mm	70361.600	70361.601	5
KEL-DPZ-HD 63 35 CR	35× 3.2 - 6.5 mm	M63 × 1.5	14 mm	75 mm	8 mm	70362.600	70362.601	5



\* The products with article ending .600 are tested and certified for particle emission for cleanroom class 1 according to ISO 14644-1. The materials used for these products have been tested and certified for outgassing according to VOC/SVOC (ISO 14644-8; ISO 16000-6,-9,-11,-25, VDI 2083 sheet 17).

\*\* The products with the article ending .601 are tested and certified for particle emission for cleanroom class 1 according to ISO 14644-1.

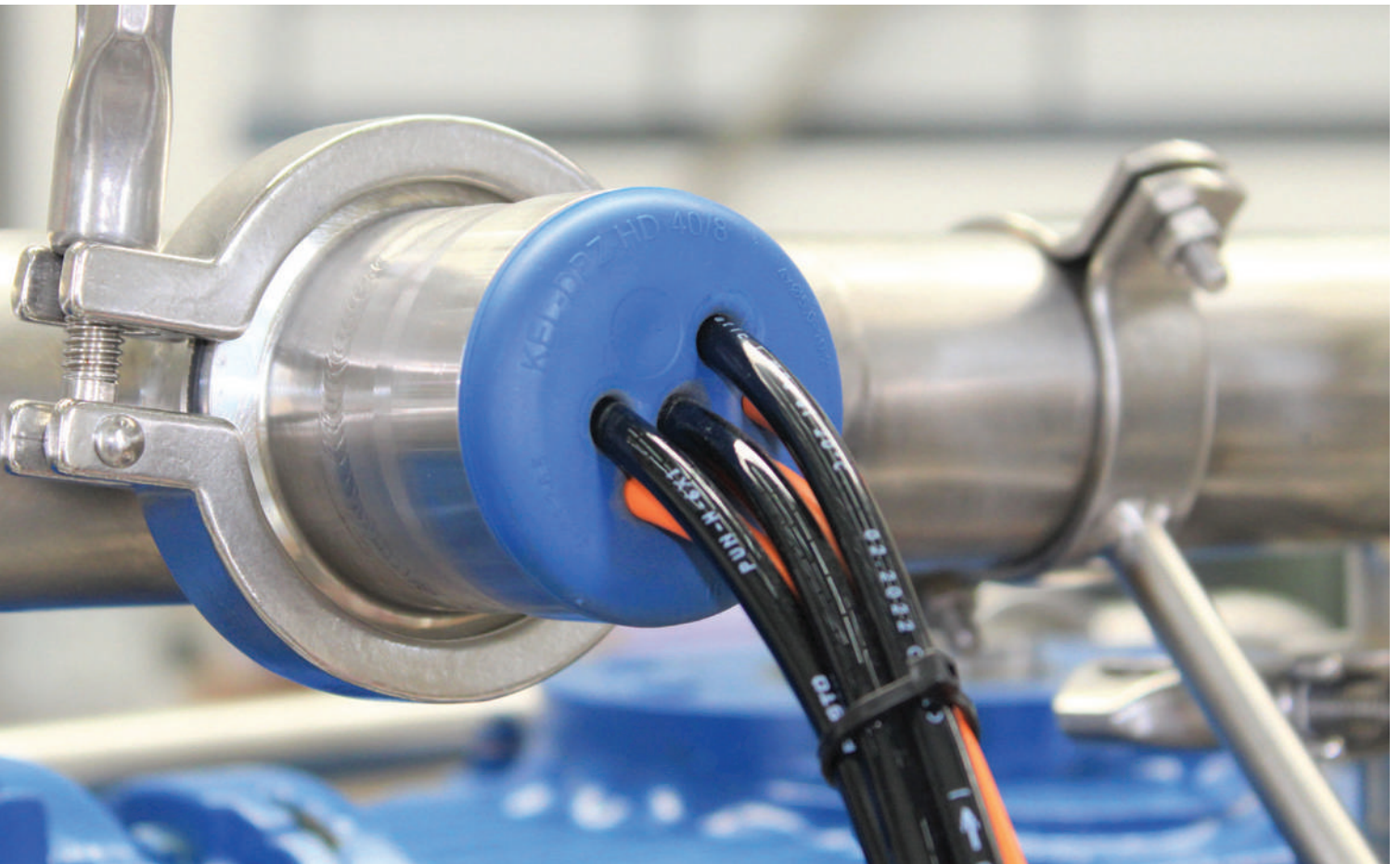

<b>BLUE LINE</b>	<b>HYGIENIC DESIGN LINE</b>	1935/ 2004/ EG	EU VO. 10/2011	<b>FDA</b>	<b>c</b> <b>UL</b> <b>US</b>	UL TYPE <b>4X</b> UL94	UL TYPE <b>12</b> UL94
<b>IP68</b>	<b>ECOLAB</b> certified	 EN ISO 14644	 PNEUMATICS	<b>RoHS</b> compliant	Made in Germany	 +80°C -40°C	 3.2-22.2mm

# Cable entry systems for the food industry

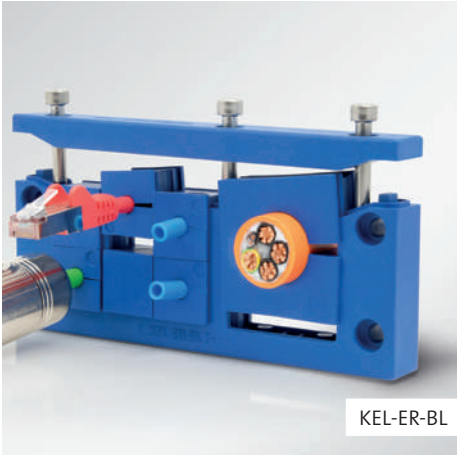

KEL-ER-BL



KT-BL



KEL-DPU-HD



KEL-DPZ-HD



ST-B-HDD



KBH-HDD

## 11 Cable entry systems for the food industry

The split cable entry frames **KEL-ER-BL** in the signal colour **blue** is preferably used in the area of **food packaging and processing machines** where there is **no direct contact with food**.

Products in this signal colour are also popular in the pharmaceutical sector. With the membrane based hygienic cable entry plates, cables or pneumatic hoses can be quickly and space-efficiently routed into control cabinets, panels and machines and can be sealed with certified protection classes up to IP66 / IP68 (acc. to EN 60529). Hygienic icotek cable entry plates are cost, space and time saving alternatives to hygienic stainless steel cable glands.



11  
11.1  
11.2

## Food production areas

1

### Food zone: Product zone

All appliance parts and components that come into direct contact with food must be washable, disinfectable, corrosion-resistant, non-toxic, non-absorbent and smooth.

#### Matching products

- Hygienic Design Line  
(depending on the application)

2

### Food zone: Splash zone

Food can come into contact with the components, but is not returned to the product cycle. As this area must also be cleaned regularly, the special requirements for the product must be observed here.

#### Matching products

- Hygienic Design Line
- Blue Line  
(depending on the application)

3

### Food zone: Product-free zone

No direct contact between food and system components. These components must be corrosion-resistant, easily washable and disinfectable.

#### Matching products

- Hygienic Design Line
- Blue Line
- Cable entry systems of product groups 1 and 2

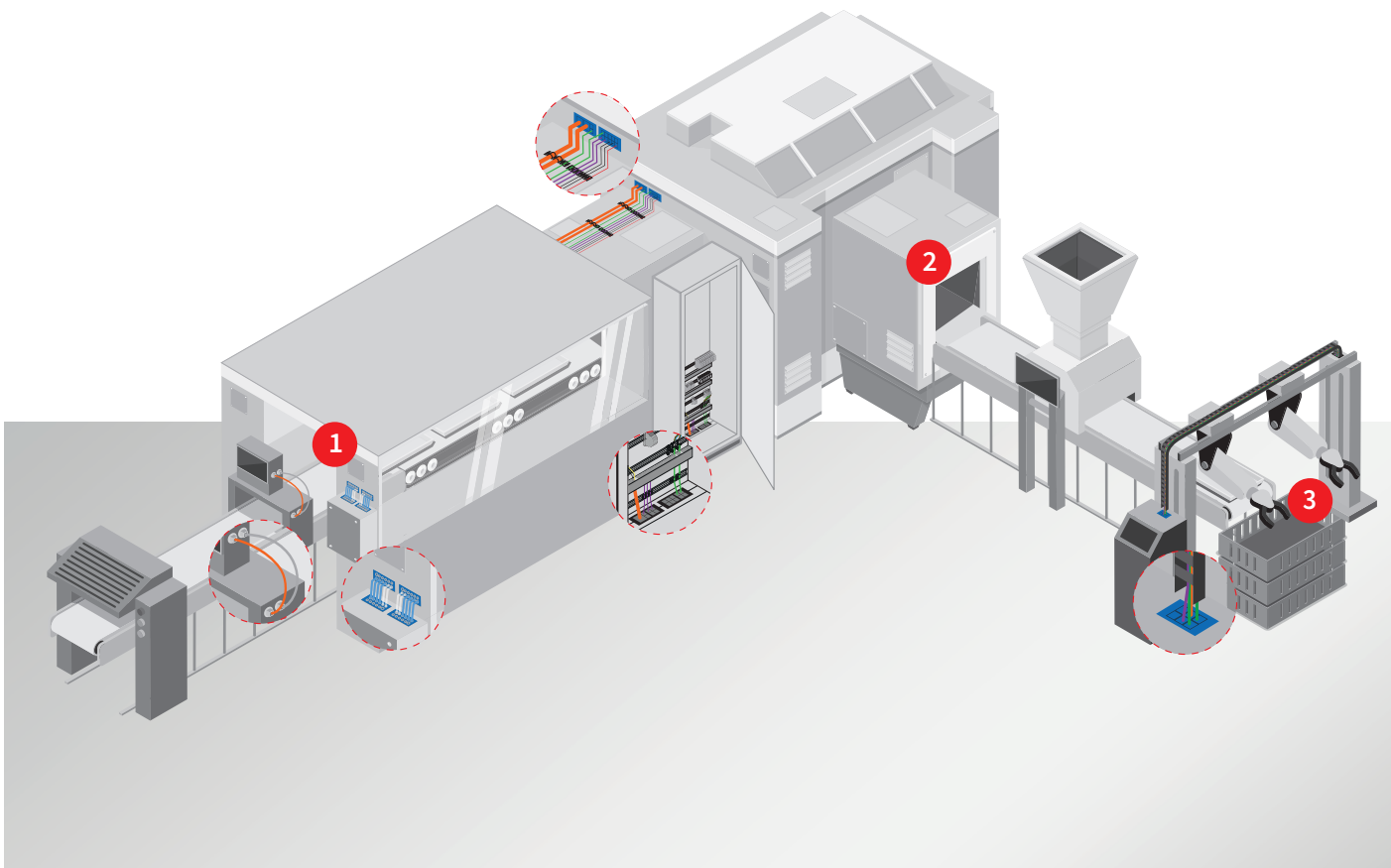

11  
11.1  
11.2

# 11.1 Cable entry frames for the food industry in signal colour blue



Split system

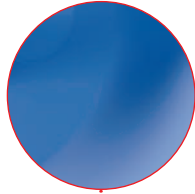

Signal colour blue (similar to Signal Blue RAL 5005)

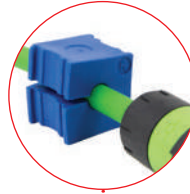

Maintain warranty on pre-terminated cables



Fast and easy assembly

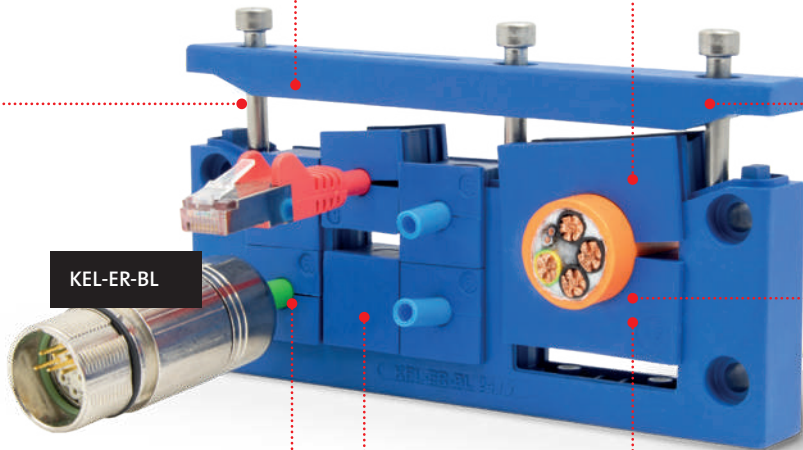

High cable density



IP65 rated protection due to a high clamping pressure on the cover lid and injected sealing

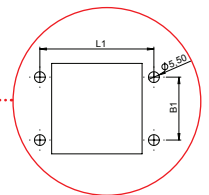

Most sizes are industrial standard cut-outs

Integrated strain relief according to EN 62444





# BLUE LINE



Split cable entry frames  
for the food industry  
in signal colour blue  
with IP65 rated protection

KEL-ER-BL series

418 – 421



Cable grommets split  
for the food industry  
in signal colour blue  
with IP65 rated protection  
for cable diameters 1 – 35 mm

KT-BL

422 – 423



Plugs for cable entry plates  
*Hygienic Design Line*

ST-B-HD | ST-B-HDD

430

# Cable entry frames for the food industry in signal colour blue with IP65 rating KEL-ER-BL series



The KEL-ER-BL in the signal colour blue is preferably used in the area of food packaging and processing machines where there is no direct contact with food. Products in this signal colour are also popular in the pharmaceutical sector.

The KEL-ER-BL is a split cable entry system for cables with and without connectors. Depending on the size, cables with a diameter of 1 to 16 mm (single grommets KT-BL 1 to KT-BL 15) or 16 to 35 mm (single grommets KT-BL 16 to 34) can be routed, sealed with IP65 and simultaneously strain-relieved according to DIN EN 62444. The cable grommets are automatically fixed into the frame during assembly. After complete fitting, the end cover is screwed on.

The KEL-ER frames match exactly the cut-out dimensions for 10-, 16- and 24-pin standard industrial connectors. Either a cut-out of 36 mm or 46 mm in height can be chosen depending on the cables being routed. The KEL-ER-B frame matches the cut-out dimensions of 46 x 46 mm measuring instruments.

The single-row cable entry KEL-ER-BL-E is characterised by its space-saving design and is therefore ideal for confined spaces and cables with flat connectors (e.g. Sub-D).

The KEL-ER-BL series is IP65 rated due to the injected seal and the use of single grommets. An additional blue flat rubber gasket is included in the shipment.

## Advantages

- Maintain manufacturer's warranty on pre-terminated cables
- Retrofittings, repairs and maintenance can be done much more easily and quickly
- High cable density, wide variety of grommets
- Strain relief according to EN 62444
- High stability, vibration resistant
- Very simple assembly

## Specifications

Material	Polyamide (PA)
Flame class	UL 94 V-0, self-extinguishing
IP rating	IP65, with gasket and correct selection of single grommets (certified acc. to EN 60529)
Colour	Blue (similar to Signal Blue RAL 5005)
Temperature	-40°C to +140°C (static)
Properties	Halogen-free, silicone-free
Frame depth	17 mm

## Accessories

KT-BL Cable grommets	422 - 423
----------------------	-----------

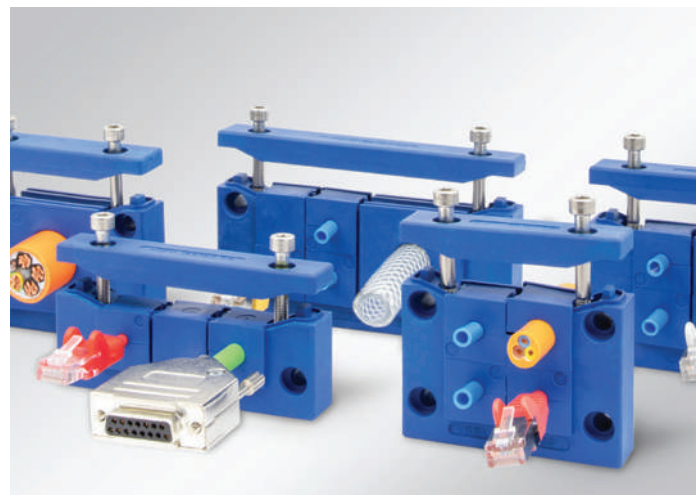
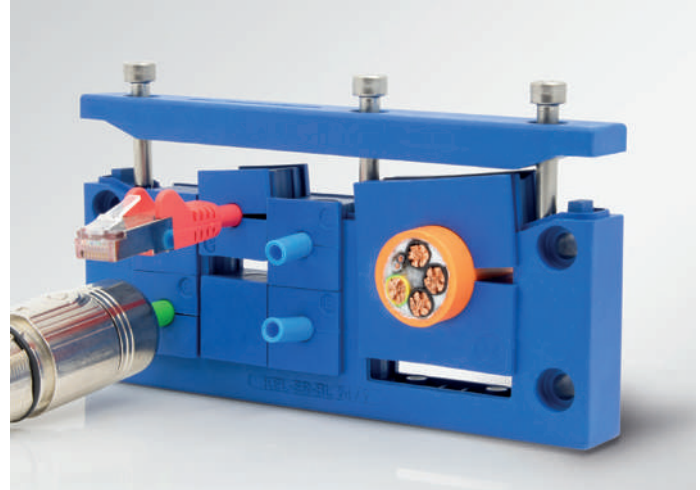

# KEL-ER-BL

Cable entry frames  
in signal colour blue

KEL-ER-BL 24, KEL-ER-BL 16



Description	Cut-out   Drilling template	Type	Cut-out mm	Grommets KT-BL small   large	Order No.	PU
		KEL-ER-BL 24 10 with V2A screws	36/46 × 112	10   –	70000.200	10
		KEL-ER-BL 24 7 with V2A screws	36/46 × 112	6   1	70001.200	10
		KEL-ER-BL 24 4 with V2A screws	36/46 × 112	2   2	70002.200	10
		KEL-ER-BL 16 8 with V2A screws	36/46 × 86	8   –	70003.200	10
		KEL-ER-BL 16 5 with V2A screws	36/46 × 86	4   1	70004.200	10
		KEL-ER-BL 16 2 with V2A screws	36/46 × 86	–   2	70005.200	10

11  
11.1  
11.2

# KEL-ER-BL

Cable entry frames  
in signal colour blue

KEL-ER-BL 10, KEL-ER-BL-B



Description	Cut-out   Drilling template	Type	Cut-out mm	Grommets KT-BL small   large	Order No.	PU
		KEL-ER-BL 10 6 with V2A screws	36/46 × 65	6   -	70006.200	10
		KEL-ER-BL 10 3 with V2A screws	36/46 × 65	2   1	70007.200	10
		KEL-ER-BL B4 with V2A screws	46 × 46	4   -	70008.200	10
		KEL-ER-BL B1 with V2A screws	46 × 46	-   1	70009.200	10

# KEL-ER-BL

## Cable entry frames in signal colour blue

### KEL-ER-BL-E



Description	Cut-out   Drilling template	Type	Cut-out mm	Grommets KT-BL small   large	Order No.	PU
		KEL-ER-BL-E5 with V2A screws	112 × 24	5   –	70010.200	10
		KEL-ER-BL-E4 with V2A screws	112 × 24	4   –	70011.200	10
		KEL-ER-BL-E3 with V2A screws	65 × 24	3   –	70012.200	10
		KEL-ER-BL-E2 with V2A screws	43 × 24	2   –	70013.200	10

## KT-BL

### Split cable grommets for KEL-ER-BL for the food industry in signal colour blue small, single

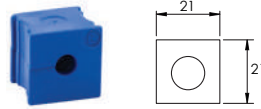

The KT-BL range of grommets are particularly suitable for use with the KEL-ER-BL cable entry frames. The signal colour blue provides clear visual colour identification.

They are designed for cable diameters from 1 to 16 mm. Blank grommets can seal unused grommet locations.

When installing the small grommets in multiple rows, the flat sides should be facing each other. This allows the flat sides to match up and provide a secure seal.

#### Advantages

- Routing of cables with and without connectors through the cable entry frame KEL-ER-BL
- High protection class up to IP65
- High strain relief in accordance with EN 62444
- Available for a wide range of cable diameters
- Signal colour blue for a clear visual colour recognition in the food industry

#### Specification

Material	Elastomer
Flame class	UL 94 V-0, self-extinguishing
IP rating	up to IP65
Colour	Blue (similar to Signal blue RAL 5005)
Temperature	-40°C to +100°C (static)
Properties	Halogen-free, silicone-free

#### Suitable for

KEL-ER-BL series 418 - 421

Description	Type	Clamping range	Order No	PU
	KT-BL 1	1 – 2 mm	70101	10
	KT-BL 2	2 – 3 mm	70102	10
	KT-BL 3	3 – 4 mm	70103	10
	KT-BL 4	4 – 5 mm	70104	10
	KT-BL 5	5 – 6 mm	70105	10
	KT-BL 6	6 – 7 mm	70106	10
	KT-BL 7	7 – 8 mm	70107	10
	KT-BL 8	8 – 9 mm	70108	10
	KT-BL 9	9 – 10 mm	70109	10
	KT-BL 10	10 – 11 mm	70110	10
	KT-BL 11	11 – 12 mm	70111	10
	KT-BL 12	12 – 13 mm	70112	10
	KT-BL 13	13 – 14 mm	70113	10
	KT-BL 14	14 – 15 mm	70114	10
	KT-BL 15	15 – 16 mm	70115	10
	BTK-BL	Blank grommet	70135	10

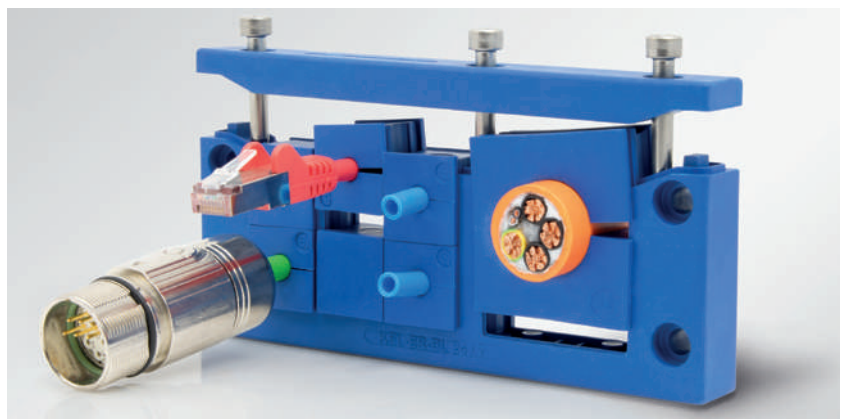

# KT-BL

Split cable grommets for KEL-ER-BL  
for the food industry  
in signal colour blue  
large, single

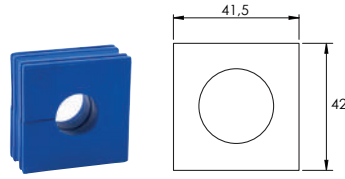

The KT-BL range of grommets are particularly suitable for use with the KEL-ER-BL cable entry frames. The signal colour blue provides clear visual colour identification.

They are designed for cable diameters from 16 to 35 mm.

### Advantages





- Routing of cables with and without connectors through the cable entry frame KEL-ER-BL
- High protection class up to IP65
- High strain relief in accordance with EN 62444
- Available for a wide range of cable diameters
- Signal colour blue for a clear visual colour recognition in the food industry

### Specifications

Material	Elastomer
Flame class	UL 94 V-0, self-extinguishing
IP rating	up to IP65
Colour	Blue (similar to Signal blue RAL 5005)
Temperature	-40°C to +100°C (static)
Properties	Halogen-free, silicone-free

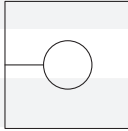
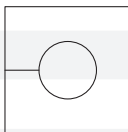
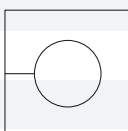
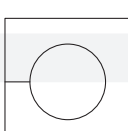
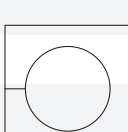
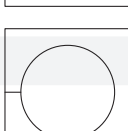
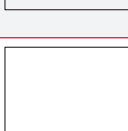
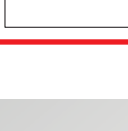
### Suitable for

KEL-ER-BL series      418 - 421

Description	Type	Clamping range	Order No	PU
	KT-BL 16	16 – 17 mm	70116	10
	KT-BL 17	17 – 18 mm	70117	10
	KT-BL 18	18 – 19 mm	70118	10
	KT-BL 19	19 – 20 mm	70119	10
	KT-BL 20	20 – 21 mm	70120	10
	KT-BL 21	21 – 22 mm	70121	10
	KT-BL 22	22 – 23 mm	70122	10
	KT-BL 23	23 – 24 mm	70123	10
	KT-BL 24	24 – 25 mm	70124	10
	KT-BL 25	25 – 26 mm	70125	10
	KT-BL 26	26 – 27 mm	70126	10
	KT-BL 27	27 – 28 mm	70127	10
	KT-BL 28	28 – 29 mm	70128	10
	KT-BL 29	29 – 30 mm	70129	10
	KT-BL 30	30 – 31 mm	70130	10
	KT-BL 31	31 – 32 mm	70131	10
	KT-BL 32	32 – 33 mm	70132	10
	KT-BL 33	33 – 34 mm	70133	10
	KT-BL 34	34 – 35 mm	70134	10
	IP54      BTG-BL	Blank grommet	70136	10



11  
11.1  
11.2

## 11.2 Cable entry plates for the food industry – Hygienic Design Line



High cable density

FDA compliant, food approval acc. to 1935/2004/EG and (EU) 10/2011, Ecolab certified

IP65 to IP68 rated protection, double cable sealing on front and back

Signal blue colour (similar to Signal Blue RAL 5005)

Fast and easy assembly

Compact, space-saving design

Very smooth surface

For metric cut-outs

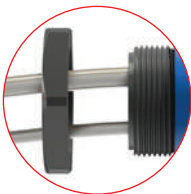

The fixation is very simple with the lock nut

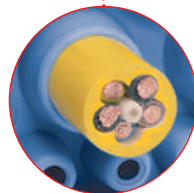

Flexible clamping range, up to 7 mm



# HYGIENIC DESIGN LINE



**Cable entry plates**  
screw-in or snap-in assembly,  
high strain relief  
*Hygienic Design Line*

KEL-DPU-HD

426 – 427



**Cable entry plates, round**  
with thread and locknut  
M32 – M63  
*Hygienic Design Line*

KEL-DPZ-HD round

428 – 429



**Plugs for cable entry plates**  
*Hygienic Design Line*

ST-B-HD | ST-B-HDD

430



**Detectable cable ties**  
and holders for cable ties  
*Hygienic Design Line*

KB-HDD | KBH-HDD

431

# Heavy-duty cable entry plates

## Hygienic Design Line

### KEL-DPU-HD

HYGIENIC  
DESIGN  
LINE

IP66

IP68

FDA

1935/  
2004/EG

EU VO.  
10/2011

The cable entry plates KEL-DPU-HD have been specially developed for installation in food processing and packaging machines. During the development according to the Hygienic Design guidelines, care was taken to ensure that the visible side of the cable entry plate are free of dirt-collecting recesses. The surface was kept very smooth. The outer contour has a radius of 6 mm instead of the required 3 mm. In addition, the KEL-DPU-HD uses an FDA-compliant elastomer in accordance with food approval 1935/2004/EG and (EU) 10/2011. The signal colour blue ensures a clear visual colour recognition.

KEL-DPU-HD entry plates are designed to route and seal cables without connectors (from 3.2 mm to 20.5 mm in diameter) in limited space with IP66/IP68\*\*. The KEL-DPU-HD is particularly characterised by its solid robust frame and the increased strain relief of the routed cables.

The KEL-DPU-HD 24 matches exactly the cut-out dimensions of 24-pin standard industrial connectors. The cable entry plate is mounted either by screwing it to the inside of the enclosure or by snapping it into the cut-out.

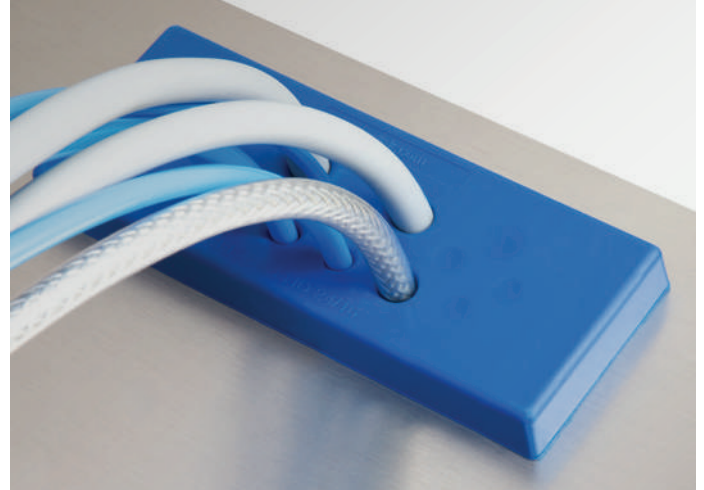

#### Advantages & benefits

- Elastomer of the cable entry plate made of material according to 1935/2004/EG, (EU) 10/2011
- FDA compliant
- Developed according to hygienic design guidelines (EHEDG)
- Hygienic design – free of dirt-collecting recesses
- Very flat design, very smooth surface (Ra 0.421 µm)
- Dual sealing of cables (IP66/IP68\*\*)
- High strength and stability
- High strain relief
- Fast and easy assembly
- Very high cable density
- Cable diameter 3.2 – 20.5 mm
- Reproducible cleaning process
- Very low moisture absorption
- High resistance to aromatic solvents, oils, greases, mineral products



#### Specifications

Material	Frame: Polypropylene (PP), sealing plate: Elastomer FDA compliant material Food approval acc. to 1935/2004/EG Food approval acc. to (EU) 10/2011
IP rating	IP65/IP66/IP67/IP68**
Flame class	UL 94 HB
Colour	Blue (similar to Signal blue RAL 5005)
Temperature	-40°C to +80°C
Properties	Halogen-free, silicone-free
For wall thickness	1.5 – 2 mm (snap-in mounting)

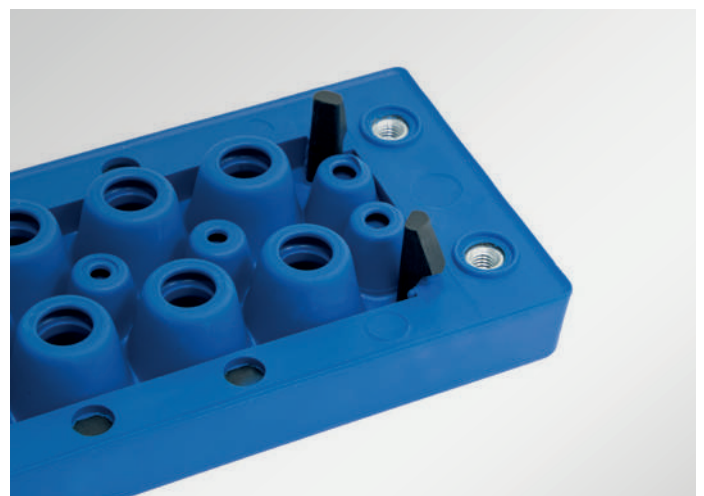

 Single-piece packaging units are available on request.

# KEL-DPU-HD

Heavy-duty cable entry plates  
with high strain relief  
*Hygienic Design Line*

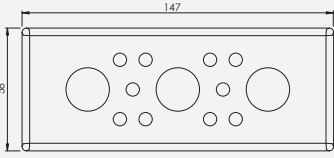
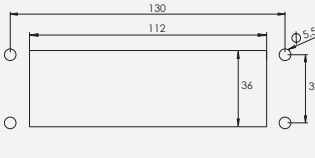
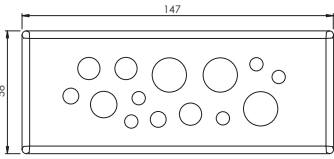
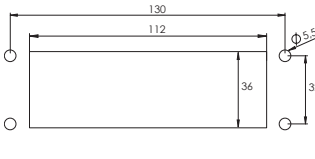
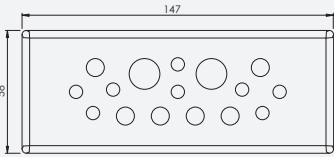
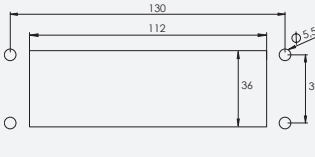
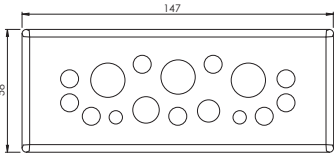
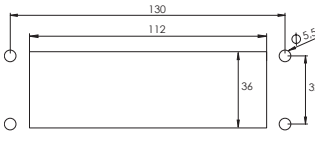
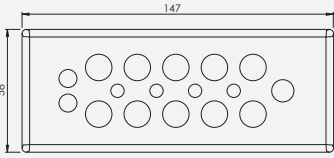
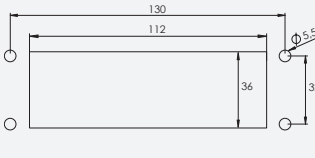
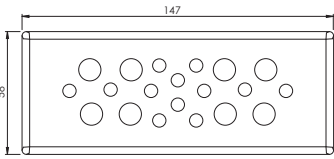
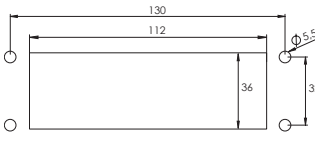
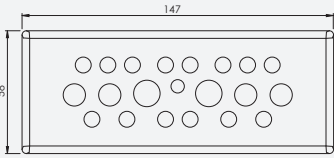
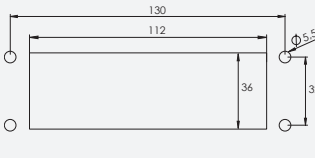
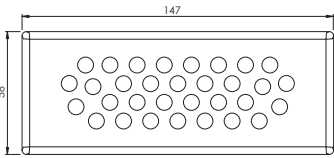
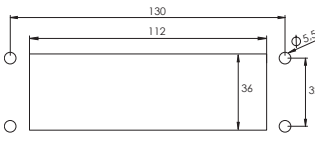

Description	Cut-out   Drilling template	Type	Cut-out mm	Number of cables	Order No.	PU
		KEL-DPU-HD 24 13 with threaded bushings M4	36 x 112 mm	10× 3.2 – 6.3 mm 3× 16 – 20.5 mm	73940	10
		KEL-DPU-HD 24 14 with threaded bushings M4	36 x 112 mm	5× 3.2 – 6.3 mm 2× 4 – 7.5 mm 3× 5.5 – 10.5 mm 1× 8 – 12.5 mm 3× 12 – 16.2 mm	73944	10
		KEL-DPU-HD 24 16 with threaded bushings M4	36 x 112 mm	8× 3.2 – 5.5 mm 6× 5 – 8.5 mm 2× 9.5 – 14.5 mm	73936	10
		KEL-DPU-HD 24 16-1 with threaded bushings M4	36 x 112 mm	2× 3.2 – 6.3 mm 9× 4 – 7.5 mm 1× 5.5 – 10.5 mm 1× 8 – 12.5 mm 3× 12 – 16.2 mm	73932	10
		KEL-DPU-HD 24 17 with threaded bushings M4	36 x 112 mm	4× 3.2 – 6.3 mm 2× 4 – 7.5 mm 1× 5.5 – 10.5 mm 10× 8 – 12.5 mm	73934	10
		KEL-DPU-HD 24 20 with threaded bushings M4	36 x 112 mm	12× 3.2 – 5.5 mm 8× 5 – 10.5 mm	73938	10
		KEL-DPU-HD 24 21 with threaded bushings M4	36 x 112 mm	1× 3.2 – 6.3 mm 14× 4 – 7.5 mm 4× 5.5 – 10.5 mm 2× 8 – 12.5 mm	73930	10
		KEL-DPU-HD 24 32 with threaded bushings M4	36 x 112 mm	32× 3.2 – 6.3 mm	73942	10

11  
11.1  
11.2

# Cable entry plates

## Hygienic Design Line

### KEL-DPZ-HD



The cable entry plates KEL-DPZ-HD with metric thread from M32 to M63 have been developed for installation in food processing and packaging machines.

During the development according to the Hygienic Design guidelines, care was taken to ensure that the visible side of the cable entry plate are free of dirt-collecting recesses. The surface was kept very smooth. The outer contour has a radius of 6 mm instead of the required 3 mm. In addition, the KEL-DPZ-HD uses an FDA-compliant elastomer in accordance with food approval 1935/2004/EG and (EU) 10/2011. The signal colour blue ensures a clear visual colour recognition.

The cable entry plates are designed to route several cables and hoses with a diameter range of 3.2 mm to 22.2 mm and seal them acc. to IP65/66/67/68. A significant advantage over cable glands is the significantly higher cable density and the flexibility of the cable diameter range. The fixation is very simple with the lock nut. A lock nut is included in the shipment.



#### Advantages & benefits

- Elastomer of the cable entry plate made of material according to 1935/2004/EG, (EU) 10/2011
- FDA compliant
- Developed according to hygienic design guidelines (EHEDG)
- Hygienic design – free of dirt-collecting recesses
- Ecolab certified
- Very flat design
- Very smooth surface (Ra 0.421 µm)
- Very fast assembly
- Cable diameter 3.2 – 22.2 mm
- Very large sealing areas and clamping areas
- High cable density
- High strain relief
- Dual sealing of cables (IP66/IP68)
- Suitable for metric cut-outs
- Reproducible cleaning process
- Very low moisture absorption
- High resistance to aromatic solvents, oils, greases, mineral products
- No corrosion possible because plastics have been processed
- Maintenance free

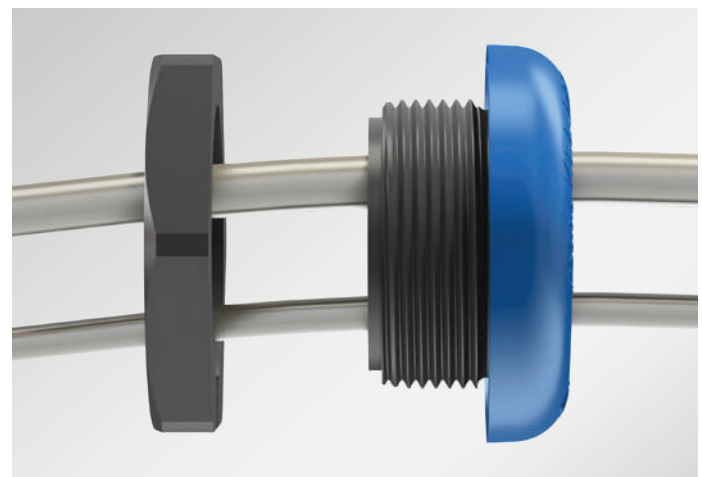

#### Specifications

Material	Polyamide and elastomer FDA compliant material Food approval acc. to 1935/2004/EG Food approval acc. to (EU) 10/2011
IP protection	IP65/66/67/68
Flame class	UL 94 HB
Colour	Blue (similar to Signal blue RAL 5005)
Temperature	-40°C to +80°C
Properties	Halogen-free, silicone-free

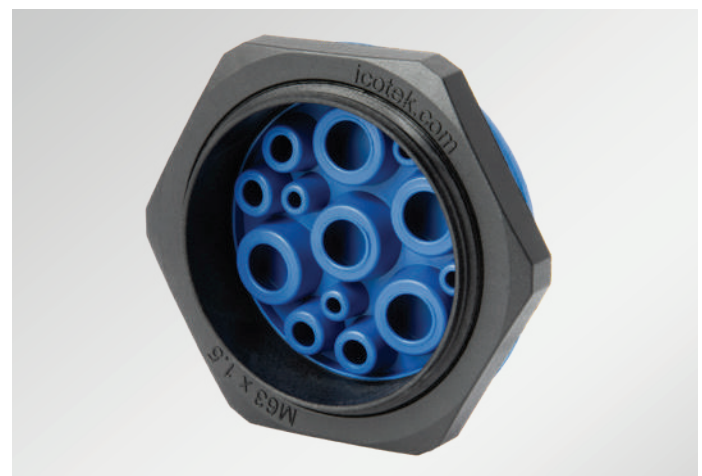

**i** The KEL-DPZ-HD is also available as a cleanroom version, see page 411.  
Single-piece packaging units are available on request.

# KEL-DPZ-HD

## Cable entry plates

*Hygienic Design Line*

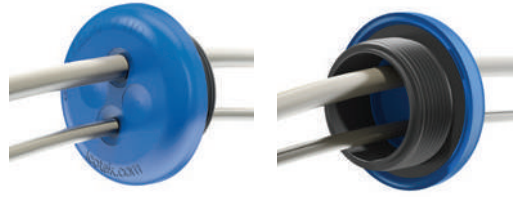

Type	Order No.	Number of cables	Thread metric	Thread length	Max. wall thickness	External diameter	Mounting height	PU
KEL-DPZ-HD 32 4	70351	3× 3.2 - 6.5 mm 1× 7.2 - 12.5 mm	M32 × 1.5	14 mm	7.0 mm	44 mm	8 mm	5
KEL-DPZ-HD 32 4-2	70352	4× 5 - 9.5 mm	M32 × 1.5	14 mm	7.0 mm	44 mm	8 mm	5
KEL-DPZ-HD 32 7	70353	7× 3.2 - 6.5 mm	M32 × 1.5	14 mm	7.0 mm	44 mm	8 mm	5
KEL-DPZ-HD 40 8	70354	4× 3.2 - 6.5 mm 4× 5 - 10.2 mm	M40 × 1.5	14 mm	7.0 mm	52 mm	8 mm	5
KEL-DPZ-HD 50 8	70355	5× 5 - 10.2 mm 3× 7.2 - 12.5 mm	M50 × 1.5	14 mm	6.0 mm	62 mm	8 mm	5
KEL-DPZ-HD 50 10	70356	7× 3.2 - 6.5 mm 2× 5 - 10.2 mm 1× 16 - 22.2 mm	M50 × 1.5	14 mm	6.0 mm	62 mm	8 mm	5
KEL-DPZ-HD 50 12	70357	4× 3.2 - 6.5 mm 8× 5 - 10.2 mm	M50 × 1.5	14 mm	6.0 mm	62 mm	8 mm	5
KEL-DPZ-HD 50 19	70358	19× 3.2 - 6.5 mm	M50 × 1.5	14 mm	6.0 mm	62 mm	8 mm	5
KEL-DPZ-HD 63 9	70359	1× 3.2 - 6.5 mm 3× 5 - 10.2 mm 4× 9 - 16.2 mm 1× 16 - 22.2 mm	M63 × 1.5	14 mm	6.0 mm	75 mm	8 mm	5
KEL-DPZ-HD 63 13	70360	4× 3.2 - 6.5 mm 4× 5 - 10.2 mm 5× 9 - 16.2 mm	M63 × 1.5	14 mm	6.0 mm	75 mm	8 mm	5
KEL-DPZ-HD 63 14	70361	14× 5 - 10.2 mm	M63 × 1.5	14 mm	6.0 mm	75 mm	8 mm	5
KEL-DPZ-HD 63 35	70362	35× 3.2 - 6.5 mm	M63 × 1.5	14 mm	6.0 mm	75 mm	8 mm	5



*Can be combined with TE-M thread extension*

\*4X for indoor use only

# ST-B-HD | ST-B-HDD

## Plugs for cable entry plates

### Hygienic Design Line



icotek offers plugs of the type ST-B-HD in the signal colour blue and in a detectable version of the type ST-B-HDD. The signal colour blue ensures a clear visual color recognition.

The ST-B-HDD plugs consist of a combination of polymer compound and metal particles. These can be sorted out using metal detectors, X-ray devices and visual detection systems.

The ST-B-HD and ST-B-HDD plugs are particularly suitable for pharmaceutical applications and for the food industry.

#### Advantages & benefits

- Sealing of pierced cable entry membranes which are no longer in use
- Blue colour for clear visual recognition
- ST-B-HDD: Detectable using metal detectors X-ray devices
- High resistance to aromatic solvents, oils, greases, mineral products

#### Specifications

Material	Polypropylene
Colour	Blue (similar to Signal blue RAL 5005)
Temperature	-40°C to +120°C
Properties	Food approval acc. to 1935/2004/EG and (EU) 10/2011 ST-B-HDD: Detectable by V2A particles

Type	Order No.	Diameter D1	Diameter D2	Length L	PU
ST-B-HD 6	70500	8 mm	6 mm	16 mm	10
ST-B-HD 10	70501	12 mm	10 mm	16 mm	10
ST-B-HD 12	70502	15 mm	12 mm	16 mm	10
ST-B-HD 16	70503	19 mm	16 mm	16 mm	10
ST-B-HD 22	70504	25 mm	22 mm	21 mm	10
ST-B-HDD 6 detectable	70620	8 mm	6 mm	16 mm	10
ST-B-HDD 10 detectable	70621	12 mm	10 mm	16 mm	10
ST-B-HDD 12 detectable	70622	15 mm	12 mm	16 mm	10
ST-B-HDD 16 detectable	70623	19 mm	16 mm	16 mm	10
ST-B-HDD 22 detectable	70624	25 mm	22 mm	21 mm	10

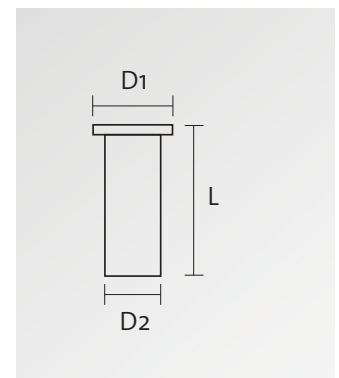

# KB-HDD | KBH-HDD

## Detectable cable ties and holders for cable ties *Hygienic Design Line*



The detectable cables ties and holders for cable ties are particularly suitable for pharmaceutical applications and for the food industry. The cable ties can be used to close packagings and transport containers.

The detectable cable ties and holders are used to install cables in the production systems. Cable ties are proven aids for the economical bundling and fastening of cables, cable harnesses, pipes and hoses. At the same time, the cable ties achieve a very high strain relief.

The holder is mounted using a screw assembly or an adhesive surface.

### Advantages & benefits

- Cable ties: High resistance to aromatic solvents, oils, greases, mineral products
- Blue colour for clear visual recognition
- Detectable using metal detectors X-ray devices
- Support in quality assurance within food production, for example within the framework of HACCP

### Specifications KB-HDD

Material	Polyamide
Colour	Blue (similar to Signal blue RAL 5005)
Temperature	-40°C to +60°C

### Specifications KBH-HDD

Material	Polyamide
Dimensions	27 x 27 mm
Colour	Blue (similar to Signal blue RAL 5005)
Temperature	-40°C to +60°C; recommended application temperature +15°C to +40°C
Properties	For cable ties up to 4.8 mm wide

### Detectable cable ties KB-HDD

Type	Length	Width	Order No.	PU
Cable ties KB 2.5 x 100 HDD	100 mm	2.5 mm	70680	100
Cable ties KB 3.6 x 150 HDD	150 mm	3.6 mm	70681	100
Cable ties KB 4.8 x 200 HDD	200 mm	4.8 mm	70682	100
Cable ties KB 4.8 x 300 HDD	300 mm	4.8 mm	70683	100

### Detectable holders for cable ties KBH-HDD

Type	Length	Width	Order No.	PU
Holder for cable ties KBH 27 x 27 HDD	27 mm	27 mm	70710	100

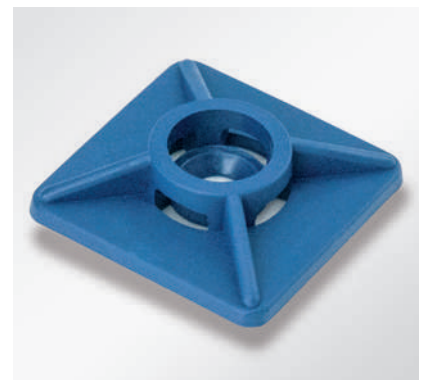
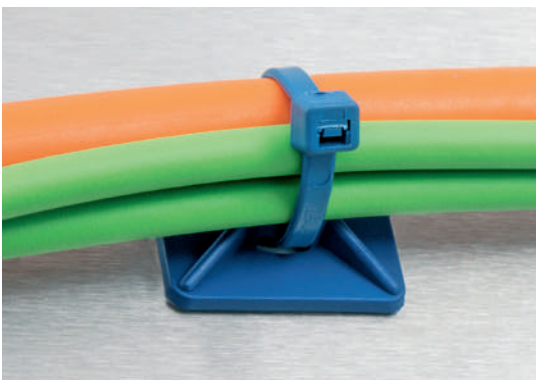

11  
11.1  
11.2





# ALLIOLIGHT

Lighting systems for industry and automation



## 12 ALLIOLIGHT Lighting systems for industry and automation



### Efficient LED lighting for industry and automation

As a long-standing partner for the industry, icotek is known worldwide for innovative cable entry systems with the highest quality standards. With the acquisition of the luminaire manufacturer Alliolight (all-in-one-light, i.e. luminaires for all areas of application in industry), founded in 1990, we are now expanding our product portfolio around the illumination of enclosures, IT applications as well as machines of all kinds. Over 30 years of experience in the field of luminaires and accessories as well as renowned customers from all over the world guarantee the highest quality – made in Germany.

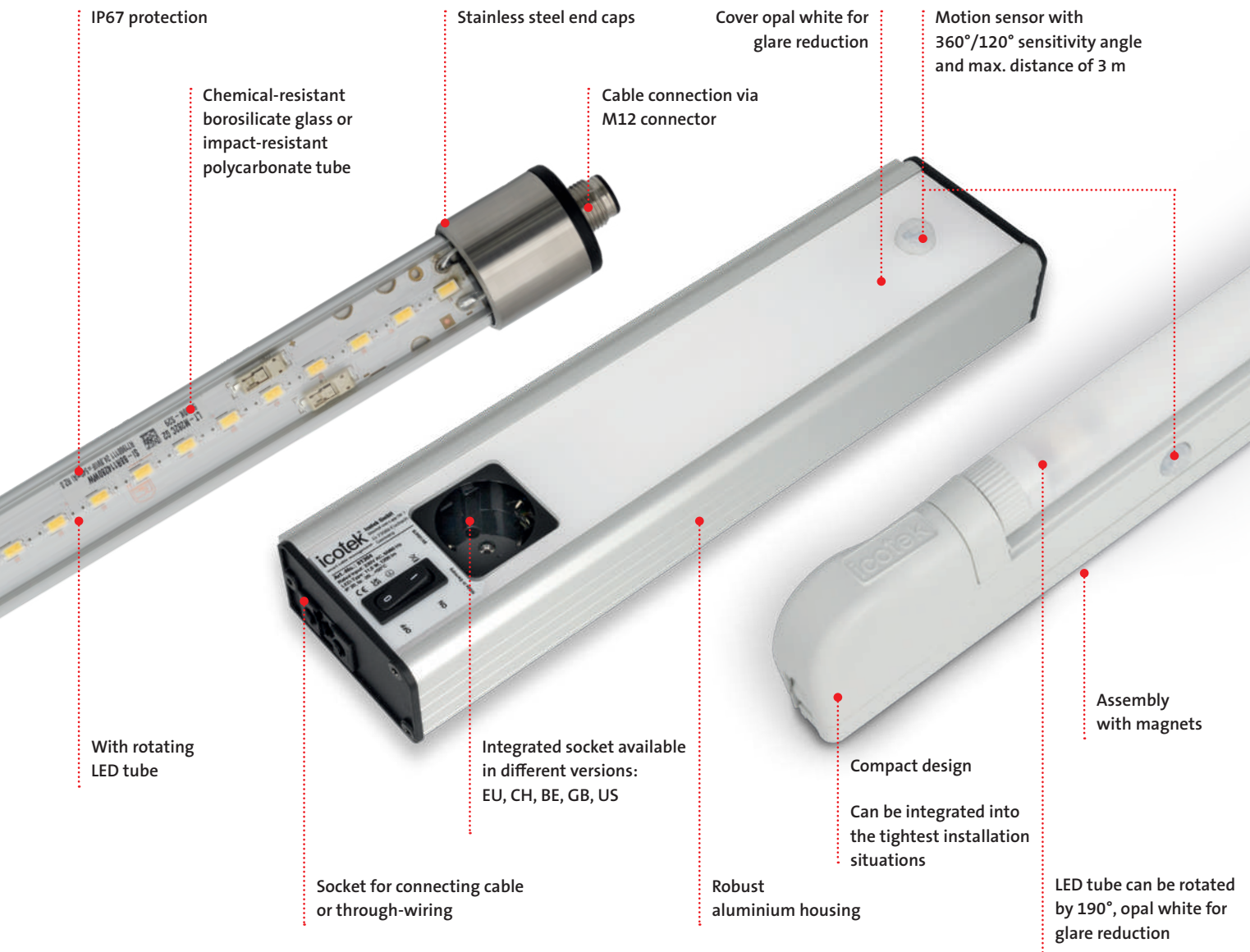

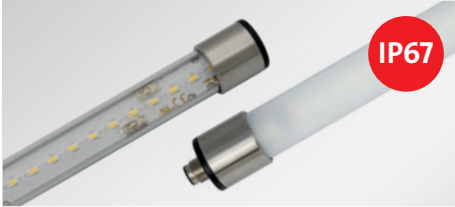

**Machine luminaire**

Chemical-resistant borosilicate glass or impact-resistant polycarbonate tube, protection class IP67 and protection category III

TUBE

436 – 437



**Enclosure luminaire**

with integrated socket, with robust aluminium housing, available with motion sensor, protection category I

ALU-LINE

438 – 441



**Enclosure luminaire**

with 190° rotating tube, available with motion sensor, protection category II

ALLIO

442 – 443



**Accessories**

for ALLIOLiGHT system luminaires

Connecting cable, through-wiring cable, door operated switch, panels

444 – 445

# Robust machine luminaire with protection class IP67 TUBE



The TUBE system luminaire provides effective lighting for machinery and equipment, with M12 connectors for standardised connection.

The luminaire is easy to mount, rotates and offers a circuit-independent service life of 50,000 operating hours.

Depending on the application, you can choose different materials for the tubes: the TUBE is available in chemical-resistant borosilicate glass and in impact-resistant polycarbonate. Fluctuating temperatures, oil, water or various chemicals therefore affect neither the luminosity nor the service life.

The connecting cable is not included in the scope of delivery and must be ordered separately. Mounting clips are included in the delivery.

## Advantages & benefits

- Chemical-resistant borosilicate glass or impact-resistant polycarbonate tube
- Protection class IP67
- Completely maintenance-free product
- High energy efficiency thanks to High Power LED
- Compact round design  $\varnothing$  28 mm, suitable for the tightest installation situations
- Easy retrofitting in existing machines
- With rotating LED tube
- Stainless steel end caps
- Cable connection via M12 connector

## Specifications

Tube material	Borosilicate glass or polycarbonate
End caps material	Stainless steel
Mounting clips material	Polypropylene (PP)
Operating voltage	24 V DC; reverse polarity protection
Rated power	see table
Protection class	IP67 (certified acc. to EN 60598-1)
Protection category	III (Protective extra-low voltage)
Operating temperature	-20°C to +50°C
Tube diameter	24 mm
End caps diameter	28 mm
Service life of illuminant	50 000 hours
Light colour	Borosilicate glass: 5000 K, Polycarbonate: 5600 K

## Accessories

Connecting cable	444
------------------	-----



LED tube in borosilicate glass



LED tube in polycarbonate

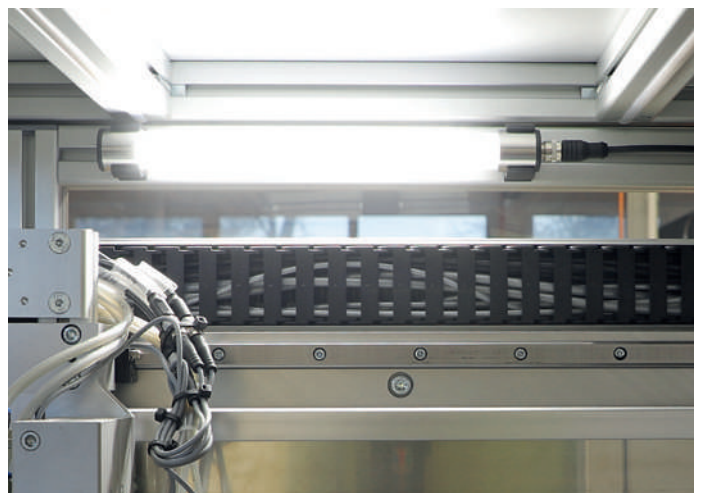

# TUBE

Robust machine luminaire  
with protection class IP67



Type	Length	Tube material	Rated power	Luminous flux Light colour	Colour rendering index CRI	Colour mounting clips	Protection class	Order No.
TUBE system luminaire 13 W	570 mm	Polycarbonate	13 W	1700 lm 5600 K	> 80	black	IP67	81500
TUBE system luminaire 26 W	1080 mm	Polycarbonate	26 W	3400 lm 5600 K	> 80	black	IP67	81501
TUBE system luminaire 8 W	300 mm	Polycarbonate	8 W	1000 lm 5600 K	> 80	black	IP67	81502
TUBE system luminaire 11,2 W	330 mm	Borosilicate glass	11,2 W	1650 lm 5000 K	> 80	black	IP67	81503
TUBE system luminaire 16,8 W	615 mm	Borosilicate glass	16,8 W	2775 lm 5000 K	> 80	black	IP67	81504

## Accessories for TUBE

Description	Length	Version	Colour	Order No.
Connecting cable	5 m	M12 connector female, open cable end	black	81530
Connecting cable	10 m	M12 connector female, open cable end	black	81531

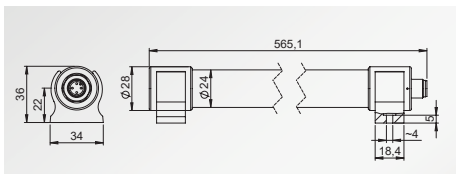

81500

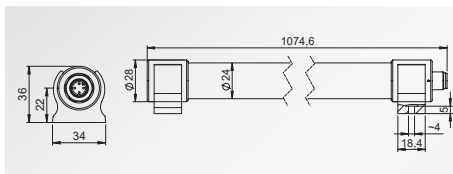

81501

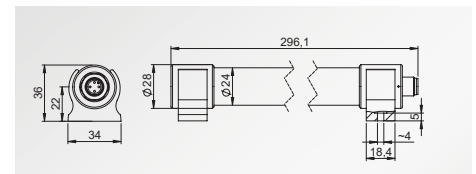

81502

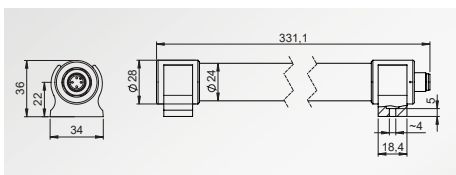

81503

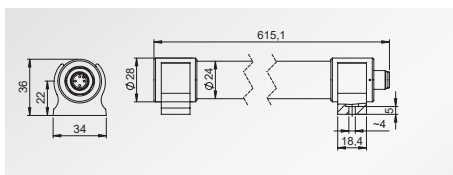

81504

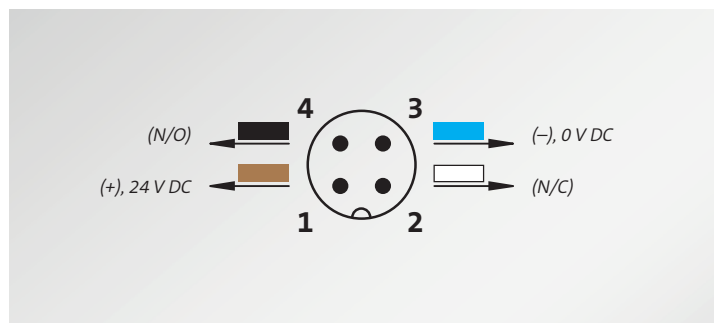
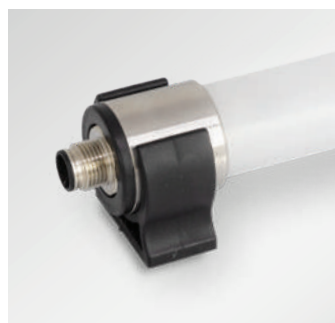

Assembly with mounting clips (included in the delivery)

12  
12.1  
12.2  
12.3  
12.4

# ALU-LINE

## LED lighting

### with and without integrated socket



The ALU-LINE system luminaires provides effective lighting in enclosures for industrial and IT applications. Their aluminium housing makes them particularly high-quality and stable.

The ALU-LINE luminaire offers an integrated socket as a practical additional benefit. This is available in EU, CH, BE, GB or US versions.

The High Power LED illuminates with up to 1350 lumens and provides a balanced homogeneous area light. Another advantage is that the through-wiring of several luminaires is possible.

Some versions are equipped with a motion sensor with 360° sensitivity angle, max. distance of 3 m and illumination time 8 minutes.

The connecting cable is not included in the scope of delivery and must be ordered separately. Mounting brackets are included in the delivery.



Available with motion sensor

#### Advantages & benefits

- Integrated socket available in different versions: EU, BE, CH, GB and US; the EU version also in orange
- High-quality and stable aluminium housing
- Various mounting types: screw assembly and assembly on top-hat rail 35 mm
- Assembly aid via integrated magnets
- Effective LED lighting with up to 1350 lm
- Available with motion sensor
- Through-wiring of several luminaires possible
- Door operated switch available as an option

#### Specifications

Cover material	Polycarbonate
Housing material	Aluminium
Motion sensor	Infrared, illumination time 8 minutes
Protection class	IP20
Protection category	I (Protective conductor connection)
Operating temperature	-20°C to +50°C
Service life of illuminant	50 000 hours
Light colour	5600 K
Luminous flux	900/1280/1350 lm
Rated voltage	see table
Rated power	6/9/12 W

#### Accessories

Door operated switch	445
Connecting cable	444
Through-wiring cable	444
Panel for 19" rack	445



# ALU-LINE

## LED lighting

with and without integrated socket



Type	Length	Material	Rated voltage	Rated power	Luminous flux Light colour	Colour rendering index CRI	Socket	UL certified in progress	Order No.
ALU-LINE system luminaire   US with motion sensor	350 mm	Aluminium, Polycarbonate	100 – 240 V AC	9 W	1280 lm 5600 K	> 80	US	●	81400
ALU-LINE system luminaire	350 mm	Aluminium, Polycarbonate	100 – 240 V AC	9 W	1280 lm 5600 K	> 80	–	●	81401
ALU-LINE system luminaire	200 mm	Aluminium, Polycarbonate	100 – 240 V AC	6 W	900 lm 5600 K	> 80	–	●	81402
ALU-LINE system luminaire   US	350 mm	Aluminium, Polycarbonate	120 V AC	12 W	1350 lm 5600 K	> 80	US	●	81403
ALU-LINE system luminaire	200 mm	Aluminium, Polycarbonate	120 V AC	12 W	1350 lm 5600 K	> 80	–	●	81404

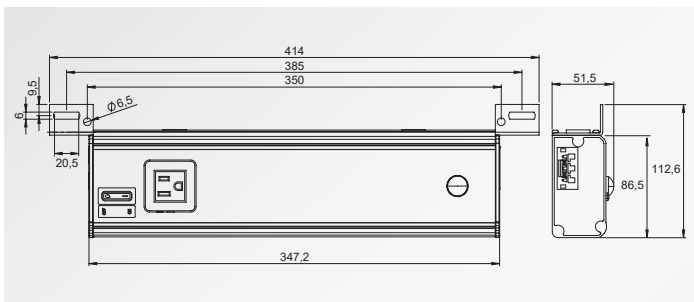

Version with US socket, with motion sensor,  
without socket for door operated switch

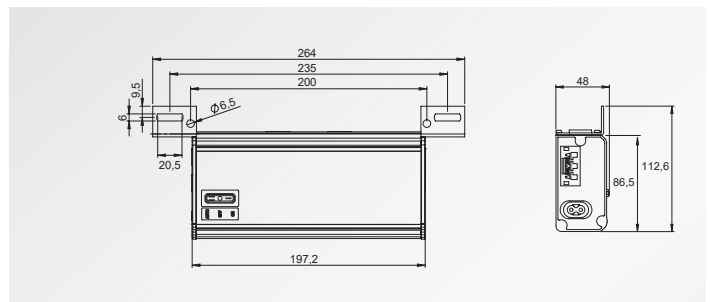

Short version without US socket, with socket for door operated switch

12  
12.1  
12.2  
12.3  
12.4

# ALU-LINE

## LED lighting

### with integrated socket



Type	Length	Rated power	Rated voltage	Luminous flux Light colour	Colour rendering index CRI	Socket	UL certified in progress	Order No.
ALU-LINE system luminaire   EU	350 mm	230 V AC	12 W	1350 lm 5600 K	> 80	EU	–	81300
ALU-LINE system luminaire   EU orange	350 mm	230 V AC	12 W	1350 lm 5600 K	> 80	EU orange	– <b>NEW</b>	81308
ALU-LINE system luminaire   BE	350 mm	230 V AC	12 W	1350 lm 5600 K	> 80	BE	–	81301
ALU-LINE system luminaire   CH	350 mm	230 V AC	12 W	1350 lm 5600 K	> 80	CH	–	81302
ALU-LINE system luminaire   GB	350 mm	230 V AC	12 W	1350 lm 5600 K	> 80	GB	–	81303
ALU-LINE system luminaire   EU with motion sensor	350 mm	230 V AC	12 W	1350 lm 5600 K	> 80	EU	–	81304
ALU-LINE system luminaire   EU orange with motion sensor	350 mm	230 V AC	12 W	1350 lm 5600 K	> 80	EU orange	– <b>NEW</b>	81309
ALU-LINE system luminaire   BE with motion sensor	350 mm	230 V AC	12 W	1350 lm 5600 K	> 80	BE	–	81305
ALU-LINE system luminaire   CH with motion sensor	350 mm	230 V AC	12 W	1350 lm 5600 K	> 80	CH	–	81306
ALU-LINE system luminaire   GB with motion sensor	350 mm	230 V AC	12 W	1350 lm 5600 K	> 80	GB	–	81307

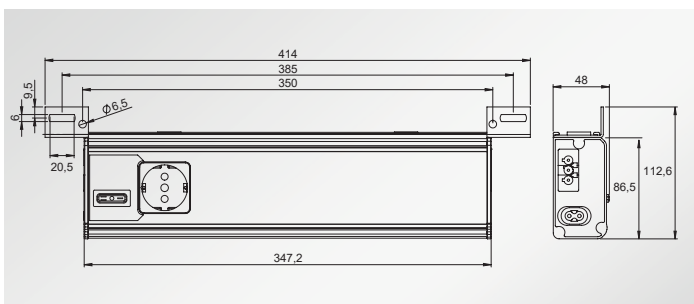

Version without motion sensor, with socket for door operated switch

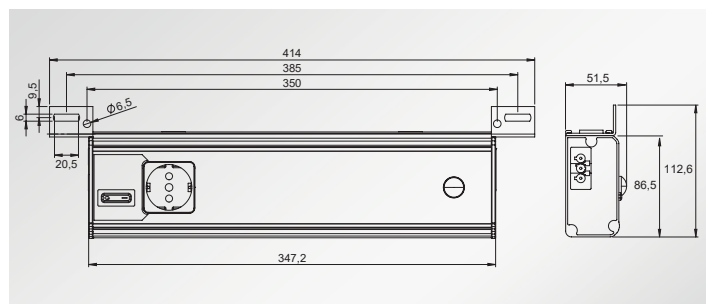

Version with motion sensor, without socket for door operated switch



## Assembly options



*Assembly with screws on profiles*



*Assembly with screws on surfaces*

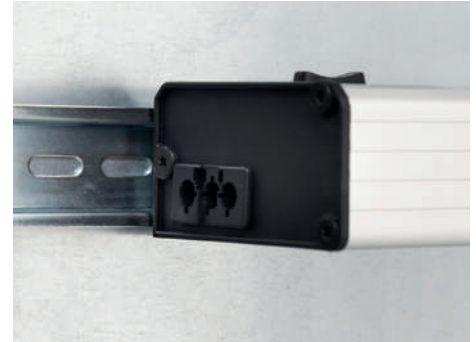

*Assembly on 35 mm top hat DIN rails*



*Assembly aid via integrated magnets*



*Available with motion sensor*



*With integrated socket*

# ALLIO

## Compact LED lighting with 190° rotating LED tube



With its compact design and 190° rotating tube, the ALLIO system luminaire offers space-saving lighting for enclosures. This also enables easy retrofitting in existing enclosures.

The High Power LED illuminates with 1050 lumens and offers a service life of at least 50,000 hours. The opal white polycarbonate tube provides a homogeneous, glare-free area light. The connecting cable is integrated.

Some versions are equipped with a motion sensor with 120° sensitivity angle, max. distance of 3 m and illumination time 30 seconds.

### Advantages & benefits

- Compact design with 190° rotating LED tube
- Various mounting types: with magnets, screw assembly or snap-in assembly in the 19" server rack
- Integrated connecting cable
- Easy retrofitting in existing enclosures
- Effective LED lighting with 1050 lumens
- Available with motion sensor
- Door operated switch available as an option

### Specifications

Tube material	Polycarbonate
Housing material	Polycarbonate
Housing colour	RAL 7035, similar light grey
Motion sensor	Infrared, illumination time 30 seconds
Protection class	IP20
Protection category	II (Protective insulation)
Operating temperature	-20°C to +50°C
Service life of illuminant	50 000 hours
Light colour	5600 K
Luminous flux	1000 lm
Rated voltage	see table; reverse polarity protection
Rated power	8 W

### Accessories

Door operated switch	445
Panel for 19" rack	445



Available with motion sensor



Panel for 19" rack available as an option

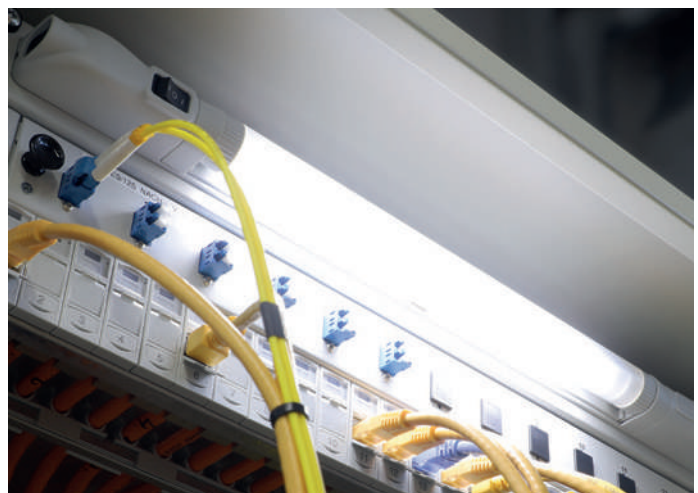

# ALLIO

## Compact LED lighting with 190° rotating LED tube



Type	Tube material	Rated voltage	Rated power	Luminous flux Light colour	Colour rendering index CRI	Connection	UL certified in progress	Order No.
ALLIO system luminaire	Polycarbonate	24 V DC	8 W	1000 lm 5600 K	> 80	3 m, ferrules	●	81202
							–	81100
ALLIO system luminaire with motion sensor	Polycarbonate	24 V DC	8 W	1000 lm 5600 K	> 80	3 m, ferrules	●	81203
							–	81101
ALLIO system luminaire	Polycarbonate	230 V AC	8 W	1000 lm 5600 K	> 80	3 m, ferrules	–	81102
ALLIO system luminaire	Polycarbonate	230 V AC	8 W	1000 lm 5600 K	> 80	1,5 m round pin attachment plug	–	81103
ALLIO system luminaire	Polycarbonate	100 – 240 V AC	8 W	1000 lm 5600 K	> 80	3 m, ferrules	●	81200
							–	81104
ALLIO system luminaire with motion sensor	Polycarbonate	100 – 240 V AC	8 W	1000 lm 5600 K	> 80	3 m, ferrules	●	81200
							–	81105

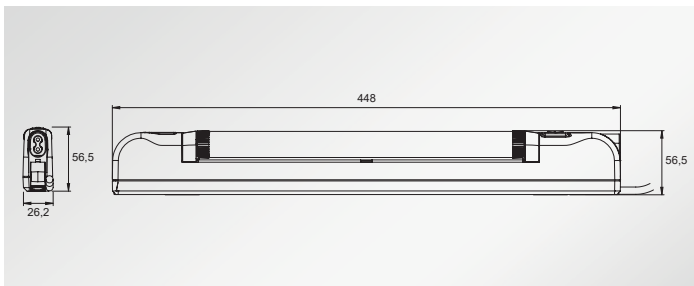

Version without motion sensor, with socket for door operated switch

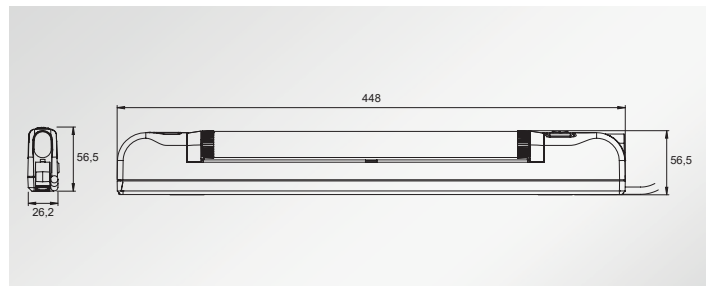

Version with motion sensor, without socket for door operated switch



Assembly with integrated magnets



Assembly with screws on profiles and surfaces



Snap-in assembly in the 19" rack

12  
12.1  
12.2  
12.3  
12.4

# Accessories

## for ALLIOLIGHT system luminaires



### Accessories for TUBE



Description	Length	Version	Colour	Order No.
Connecting cable	5 m	M12 connector female, open cable end	black	81530
Connecting cable	10 m	M12 connector female, open cable end	black	81531

Description	Inner diameter	Material	Colour	Order No.
Mounting clips (spare part)	28 mm	Polypropylene (PP)	black	91070
Mounting clips (spare part) Bore 6.5 mm	28 mm	Stainless steel	Stainless steel	91443

### Accessories for ALU-LINE



Description	Length	Version	UL certified in progress	Order No.
Connecting cable	3 m	Connector GST18 female, wire end ferrules	●	81430
			—	81330

Description	Length	Version	UL certified in progress	Order No.
Through-wiring cable	0,6 m	Connector GST18 female, male	●	81431
			—	81331
Through-wiring cable	1,0 m	Connector GST18 female, male	●	81432
			—	81332

# Accessories

## for ALLIOLiGHT system luminaires



### Accessories for ALU-LINE and ALLIO



Description	Length connection cable	Connector	UL certified in progress	Order No.
Door operated switch	1,5 m	angled	–	81333
Door operated switch	0,6 m	angled	–	81334
Door operated switch	0,6 m	straight	● –	81232 81132
Door operated switch	1,5 m	straight	● –	81233 81133

### Accessories for ALU-LINE

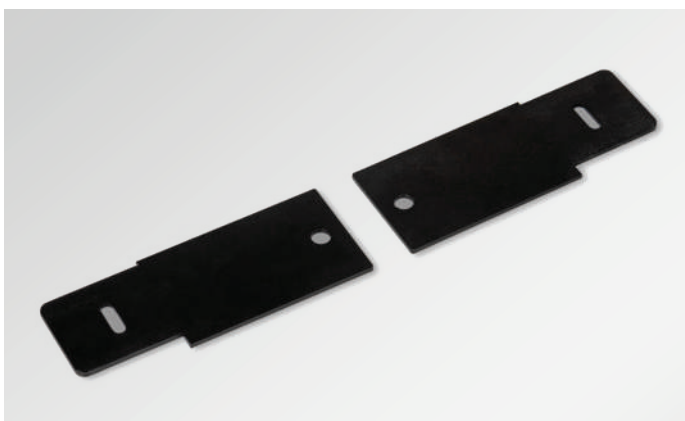

Description	Dimensions	drill-hole-Ø	Surface	Colour	Order No.
Mounting plate for 19" rack	111 x 43,4 mm	7 mm	powder-coated	black	81337

### Accessories for ALLIO



Description	Surface	Colour	Order No.
Panel for 19" rack	powder-coated	RAL 7035 light grey	81134
Panel for 19" rack	powder-coated	RAL 9005 black	81135

\* only fits ALLIO lumieres without motion sensor

12  
12.1  
12.2  
12.3  
12.4

# Certificates



Product	IP rating						UL 50E rating		cURus	RINA	DNV-GL	EN45545-2	UV	ECOLAB	RoHS	Cleanroom	Flame class	UL94	Halogen free
	IP54	IP64	IP65	IP66	IP67	IP68	12	4X											
<b>Product group 1</b>																			
KEL 24/16/10/-B	■						■	■	■	■	■	■	■	■			■	■	
KEL 24-E/-MT/-2MT	■							■	■	■	■	■	■	■			■	■	
KEL 16-E/-MT/-2MT	■								■		■	■	■	■			■	■	
KEL-ER 24/16/10/-B	■	■	■	■			■	■	■		■	■	■	■			■	■	
KEL-U 24/16/10/-B	■						■	■	■		■	■	■	■			■	■	
KEL-E	■						■		■	■	■	■	■	■			■	■	
KEL-ER	■	■	■	■			■	■	■		■	■	■	■			■	■	
KEL-FA	■											■	■	■			■	■	
KEL-FG	■						■	■		■	■	■	■	■			■	■	
KEL-FG-ER	■	■	■					■			■	■		■			■	■	
KEL-FW	■	■	■						in progress		■			■			■	■	
KEL-SNAP	■						■	■			■		■	■			■	■	
KVT-ER	■	■	■	■	■	■	■	■	■		■		■	■			■	■	
KVT gy	■						■	■	■	■	■		■	■			■	■	
KVT bk	■						■	■	■	■			■	■			■	■	
KVT 80 gy	■						■	■	■		■		■	■			■	■	
KVT 80 bk	■						■	■	■				■	■			■	■	
KVT-SNAP	■							■		■	■		■	■			■	■	
KVT-W90 gy	■							■		■	■		■	■			■	■	
KVT-W90 bk	■							■		■			■	■			■	■	
DB	■								in progress		■		■	■			■	■	
KT small gy, single	■	■	■	■	■	■	■	■	■	■	■		■	■			■	■	
KT small bk, single	■	■	■	■	■	■			■				■	■			■	■	
KT small gy, multi	■						■	■	■		■		■	■			■	■	
KT small bk, multi	■								■				■	■			■	■	
KT large gy	■	■	■	■	■	■	■	■	■	■	■		■	■			■	■	
KT large bk	■	■	■	■	■	■			■				■	■			■	■	
KTMB5	■						■	■			■		■	■			■	■	
KTMB small/ large	■						■	■	■		■		■	■			■	■	
KT-DPF small gy	■						■	■	■		■		■	■			■	■	
KT-DPF small bk	■								■				■	■			■	■	
KT-DPF large gy	■						■	■	■		■		■	■			■	■	
KT-DPF large bk	■								■				■	■			■	■	

# Certificates



Product	IP rating						UL 50E rating		cURus	RINA	DNV-GL	EN45545-2	UV	ECOLAB	RoHS	Cleanroom	Flame class	UL94	Halogen free
	IP54	IP64	IP65	IP66	IP67	IP68	12	4X											
DT	■						■	■	■		■	■	■	■			■	■	
ST							■	■						■			■	■	
KEL-FL	■							■		■	■	■	■	■			■	■	
FT	■							■		■	■	■	■	■			■	■	
KEL 183	■						■	■	■		■	■	■	■			■	■	
KEL 183-E	■						■	■	■		■	■	■	■			■	■	
KTMB 183	■						■	■	■		■	■	■	■			■	■	
KEL-JUMBO	■						■	■	■		■	■	■	■			■	■	
KTF	■						■	■	■		■	■	■	■			■	■	
KTF-SCDP	■						■	■	■		■	■	■	■			■	■	
KEL-QUICK 24/16/10/-B/-E	■						■	■			■	■	■	■			■	■	
QVT	■									■	■		■	■			■	■	
QVT-CLICK	■										■		■	■			■	■	
KEL-QTA 24/10/-B/round	■							■	■		■	■	■	■			■	■	
KEL-QTE	■							■	■		■	■	■	■			■	■	
QT	■							■			■	■	■	■			■	■	
UT/UT-DT	■								in progress		■	■	■	■			■	■	
<b>Product group 2</b>																			
KEL-DPU 24 gy	■	■	■	■	■	■	■	■	■	■	■	■	■	■			■	■	
KEL-DPU 24 bk	■	■	■	■	■	■	■	■	■	■	■	■	■	■			■	■	
KEL-DPZ 24 gy	■	■	■	■			■	■	■	■	■	■	■	■			■	■	
KEL-DPZ 24 bk	■	■	■	■			■	■	■	■	■	■	■	■			■	■	
KEL-DPZ 16/10/6	■	■	■	■					■			■	■	■			■	■	
KEL-DPZ-B gy	■	■	■	■			■	■	■	■	■	■	■	■			■	■	
KEL-DPZ-B bk	■	■	■	■			■	■	■	■	■	■	■	■			■	■	
KEL-DPZ-E gy	■	■	■	■			■	■	■	■	■	■	■	■			■	■	
KEL-DPZ-E bk	■	■	■	■			■	■	■	■	■	■	■	■			■	■	
KEL-DPZ-KL gy	■	■	■				■	■	■	■	■	■	■	■			■	■	
KEL-DPZ-KL bk	■	■	■				■	■	■	■	■	■	■	■			■	■	
KEL-DPZ round gy	■	■	■	■	■	■	■	■	■	■	■	■	■	■			■	■	
KEL-DPZ round bk	■	■	■	■	■	■	■	■	■	■	■	■	■	■			■	■	
KEL-DPZ-CLICK	■	■	■	■	■	■			■	■	■	■	■	■			■	■	
KEL-DPR	■	■	■									■	■	■			■	■	
KEL-DP 24 gy	■	■					■	■	■	■	■	■	■	■			■	■	
KEL-DP 24 bk	■	■					■	■	■	■	■	■	■	■			■	■	
KEL-DP 16/10/6	■	■							■	■	■	■	■	■			■	■	

# Certificates



Product	IP rating						UL 50E rating		cURus	RINA	DNV-GL	EN45545-2	UV	ECOLAB	RoHS	Cleanroom	Flame class	UL94	Halogen free
	IP54	IP64	IP65	IP66	IP67	IP68	12	4X											
KEL-DP-E gy	■	■					■	■	■	■	■	■	■	■			■	■	
KEL-DP-E bk	■	■					■	■	■	■	■	■	■	■			■	■	
KEL-DP round gy	■	■	■				■	■	■	■	■	■	■	■			■	■	
KEL-DP round bk	■	■	■				■	■	■	■	■	■	■	■			■	■	
ST-B							■	■									■	■	
KEL-SCDP-TR	■	■	■										■	■	■		■	■	
KEL-SCDP   KEL-SCDP-RW	■	■	■								- ■	■	■	■			■	■	
KEL-DPF gy	■	■	■	■		■		■	■	■	■	■	■	■			■	■	
KEL-DPF bk	■	■	■	■		■		■	■	■	■	■	■	■			■	■	
KEL-JUMBO flex	■						■	■			■	■	■	■			■	■	
KEL-ULTRA flex	■	■	■	■			■	■	■	■	■	■	■	■			■	■	
<b>Product group 3</b>																			
KZL									■	■	■	■	■	■			■	■	
SF ZL									■	■	■	■	■	■			■	■	
ZL									■	■	■	■	■	■			■	■	
ZL-AB									■	■	■	■	■	■			■	■	
ZL 03 04 05									■	■	■	■	■	■			■	■	
KBH-S/KBH-R											■	■							
MSMC											■	■	■	■			■	■	
<b>Product group 4</b>																			
EMC-KEL-DS	■								■					■		■		■	
EMC-KVT-DS	■								■					■		■		■	
<b>Product group 5</b>																			
CONFIX FWS-A/-B gy	■													■			■	■	
CONFIX FWS-A/-B bk	■													■			■	■	
<b>Product group 6</b>																			
KDR(S)-ESR/KDR-VX25	■										■			■			■	■	
KDR2/KDR-BMP/MP	■													■					
FP-AX/FP-AE	■	■	■	■										■					
FP-KX/KL	■													■					
FP-BG/FP-FL21	■													■					
BPK	■	■					■	■						■			■	■	
BPK-RF	■						■	■						■			■	■	
BPM	■	■	■											■					
BPK-SNAP	■													■		■			



# Certificates



Product	IP rating						UL 50E rating		cURus	RINA	DNV-GL	EN45545-2	UV	ECOLAB	RoHS	Cleanroom	Flame class	UL94	Halogen free
	IP54	IP64	IP65	IP66	IP67	IP68	12	4X											
TE-M																			
KEA	■	■	■	■								■		■	■			■	■
Drainage device	■	■	■	■	■	IP69K			■										
PCE	■	■	■	■	■	■													■
KGM									■									■	■
<b>Product group 7</b>																			
KEL-BES(-S) 24/16/10/round																		■	■
<b>Product group 10</b>																			
KEL-ER CR	■	■	■	■				■	■	■		■	■	■	■	■	■	■	■
KEL-U CR	■							■	■	■		■	■	■	■	■	■	■	■
KEL-DPZ CR gy/bk	■	■	■	■				■	■	■	■	■ -	■	■	■	■	■	■	■
KEL-DPZ round CR gy/bk	■	■	■	■	■	■		■	■	■	■	■ -	■	■	■	■	■	■	■
KEL-DPZ-HD CR	■	■	■	■	■	■			■					■	■	■	■	■	■
<b>Product group 11</b>																			
KEL-ER-BL series	■	■	■						in progress				■	■	■			■	■
KT-BL	■	■	■						in progress				■	■	■			■	■
KEL-DPU-HD	■	■	■	■	■	■								■	■				■
KEL-DPZ-HD	■	■	■	■	■	■			■					■	■				■
<b>Product group 12</b>																			
TUBE	■	■	■	■	■				in progress						■				
ALU-LINE		IP20							in progress						■				
ALLIO		IP20							in progress						■				

# Appendix

## IP protection classes

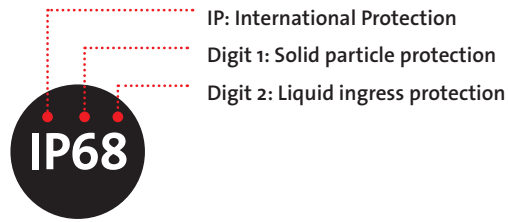

IP protection classes according to EN 60529

1st digit	Solid particle protection...		2nd digit	Liquid ingress protection...	
0		no protection	0		no protection
1		against any surface of the body > 50 mm	1		against dripping water (vertically falling drops)
2		against any surface of the body > 12.5 mm	2		against dripping water when tilted at 15°
3		against objects > 2.5 mm (tools)	3		against spraying water at any angle up to 60°
4		against objects > 1 mm (most wires)	4		against splashing water from any direction
5		Dust protected	5		against water jets from any direction
6		Dust tight	6		against powerful water jets from any direction by a nozzle
6			7		Suitable for temporary immersion in water up to 1 m depth
6			8		Suitable for continuous immersion in water*

\*specified by the manufacturer

## Appendix

### UL type rating vs. NEMA rating

#### Why you should only rely on the UL Type Rating according to UL 50E

##### UL type rating acc. to UL 50E

The UL type rating is required for enclosures, cable entry components etc. for which an UL approval is required – regardless of the installation location. The UL type rating according to UL 50E requires intensive testing!

If a customer has to deliver a device according to UL Type 4X to the U.S. and installs a cable entry component, the manufacturer of which only specifies as NEMA 4X, this can lead to big problems. The UL inspector who approves the device usually also requests the corresponding test certificate from the UL. If this cannot be shown, the component has to be removed because the device does not meet the requirements of UL 50E.

**All icotek products with a type rating have been tested and certified by UL according to UL 50E!**



##### NEMA types

Using the NEMA rating lies with the responsibility of the manufacturer. That means: For enclosures, cable entry components etc. that are not particularly used for the North American market and for which no UL approval is required, the NEMA rating is sufficient.

It is also the sole responsibility of the manufacturer whether he checks the component on tightness at all or whether he just claims a NEMA conformity. An examination is not absolutely necessary. Regardless of whether the product is delivered to the USA or not, proof that the product corresponds to the tightness specified by the manufacturer is ensured by the type test according to UL 50E.



## Appendix

### Flammability classification according to UL 94



#### Flame class UL 94 HB

Applying the horizontal burning test the material burns slowly. For parts with a thickness up to 3 mm the burning speed must not be faster than 3 inches/min and for parts with a thickness over 3 mm the burning speed must not be faster than 1.5 inches/mm.

Materials which burn faster are not UL certified.

#### Flame class UL 94 V-2

Applying the vertical burning test, the material must normally extinguish itself after 25 seconds or less, but max. after 30 seconds. The material may drop and cotton wool placed under the probe may inflame. The material must not glow longer than 60 seconds.

#### Flame class UL 94 V-1

Applying the vertical burning test, the material must normally extinguish itself after 25 seconds or less, but max. after 30 seconds. The material may drop and cotton wool placed under the probe may inflame. The material must not glow longer than 30 seconds.

#### Flame class UL 94 V-0

Applying the vertical burning test, the material must normally extinguish itself after 5 seconds or less, but max. after 10 seconds. The material may drop down, but cotton wool placed under the probe must not inflame. The material must not glow longer than 30 seconds.

## Appendix

### General reference notes



We provide all the information on chemical and physical properties of our products and technical advice to the best of our knowledge.

Please do your own examinations and tests to determine the practical suitability of the products for the usage intended.

Application, use and installation of the products is the customer's responsibility. Legal and regulatory provisions and any rights to third parties have to be observed.

Moreover our general terms and conditions, which can be requested from us, apply.

This catalogue was prepared with the greatest care. All technical data and information have been reviewed before printing. Due to continuous improvement and development of our production programme we reserve, modify products from this catalogue or to take out products from our product range. Therefore, technical information and products which are included in this catalogue may differ – without prior notice.

Full or partial use and reproduction of this catalogue (drawings, images, texts, logos) are prohibited without written permission.

# Appendix

## Reference list

Order No.	Page	Order No.	Page	Order No.	Page	Order No.	Page	Order No.	Page	Order No.	Page	Order No.	Page
31100	346	31606	291	32367	195	32817	268	36256	234	36708	243	38020	257
31105	346	31610	291	32400	219	32823	268	36257	234	36810	237	38025	257
31110	346	31612	291	32401	219	32824	268	36258	234	36815	237	38030	257
31120	346	31614	291	32410	219	32825	268	36259	234	36820	237	38035	257
31130	346	31616	291	32411	219	32847	268	36282	239	36850	236	38040	257
31140	346	31618	291	32420	219	32848	268	36283	239	36855	236	38045	257
31200	292	31620	291	32421	219	32849	268	36284	239	36860	236	38050	257
31210	292	31622	291	32430	219	32850	268	36285	239	36865	236	38105	258
31215	292	31624	291	32431	219	32868	268	36286	239	36870	236	38110	258
31220	292	31626	291	32598	219	32870	268	36287	239	36875	236	38115	258
31230	292	32000	192	32599	219	32872	268	36322	265	36880	236	38120	258
31235	292	32001	192	32596	219	32873	267	36323	265	36885	236	38125	258
31240	292	32002	192	32597	219	32878	266	36324	265	36910	232	38130	258
31250	292	32003	192	32695	266	32886	268	36326	265	36915	232	38135	258
31260	292	32004	192	32700	266	36000	347	36328	265	36920	232	38140	258
31300	293	32005	192	32701	266	36002	347	36330	265	36925	232	38145	258
31310	293	32006	192	32702	266	36008	347	36332	265	36930	232	38150	258
31315	293	32007	192	32703	266	36010	347	36400	264	36935	232	39110	262
31320	293	32112	196	32704	266	36016	347	36412	264	36940	232	39150	261
31330	293	32114	196	32705	266	36018	347	36414	264	36941	232	39160	261
31335	293	32116	196	32706	266	36024	347	36416	264	36952	259	39170	261
31340	293	32222	194	32707	266	36026	347	36418	264	36953	259	39180	261
31350	293	32224	194	32709	266	36032	347	36422	264	36954	259	39181	261
31360	293	32226	194	32730	266	36034	347	36424	264	36955	259	39183	261
31380	288	32228	194	32731	266	36040	347	36426	264	36958	259	39184	261
31381	288	32230	194	32732	266	36042	347	36428	264	36962	259	39190	261
31383	288	32232	194	32733	266	36048	347	36430	264	36963	259	39191	301
31384	288	32234	194	32734	266	36050	347	36432	264	36965	259	39192	301
31386	288	32236	194	32735	266	36056	347	36434	264	36984	259	39710	266
31387	288	32250	197	32736	266	36058	347	36436	264	36985	259	39711	266
31389	288	32251	196	32737	266	36064	347	36438	264	37150	265	39800	391
31390	288	32252	196	32738	266	36066	347	36440	264	37152	265	39900	76
31392	288	32260	197	32739	266	36072	347	36442	264	37154	265	39901	76
31393	288	32262	197	32741	266	36074	347	36444	264	37156	265	39902	80
31395	288	32264	197	32742	266	36100	347	36446	264	37158	265	39903	80
31396	288	32270	195	32743	266	36200	229	36448	264	37159	265	39904	80
31410	289	32271	195	32744	266	36202	229	36450	264	37306	260	39905	80
31411	289	32272	195	32746	266	36204	229	36452	264	37374	234	39906	80
31413	289	32273	195	32758	267	36205	229	36454	264	37375	234	39907	80
31414	289	32274	195	32759	267	36206	229	36458	264	37600	229	39908	80
31416	289	32275	195	32760	267	36207	229	36459	264	37602	229	39909	80
31417	289	32276	195	32761	267	36208	229	36460	264	37608	234	39910	80
31419	289	32277	195	32762	267	36209	229	36462	264	37610	234	39911	80
31420	289	32280	195	32763	267	36213	229	36464	264	37612	232	39912	76
31422	289	32281	195	32764	267	36216	229	36465	264	37614	232	39913	76
31423	289	32282	195	32765	267	36217	229	36466	264	37616	237	39914	80
31425	289	32283	195	32766	267	36218	229	36467	264	37618	237	39915	80
31426	289	32284	195	32767	267	36220	235	36470	264	37620	236	39916	80
31550	290	32285	195	32768	267	36221	235	36471	264	37622	236	39917	80
31552	290	32286	195	32769	267	36222	233	36472	264	37630	238	39918	80
31554	290	32287	195	32770	267	36224	233	36482	264	37632	238	39921	80
31556	290	32290	195	32771	267	36226	234	36484	264	37640	246	39922	80
31558	290	32291	195	32772	267	36228	234	36486	264	37642	246	39923	80
31560	290	32292	195	32773	267	36229	235	36488	264	37650	246	39924	80
31562	290	32293	195	32774	267	36230	235	36490	264	37652	246	39929	80
31564	290	32294	195	32775	267	36231	235	36500	236	37680	245	39930	80
31566	290	32295	195	32776	267	36232	236	36502	236	37681	245	39931	80
31570	290	32296	195	32777	267	36234	264	36504	237	37682	245	39932	80
31572	290	32297	195	32778	267	36235	238	36506	237	37683	245	39933	80
31574	290	32351	198	32800	267	36236	238	36520	262	37684	245	39934	76
31576	290	32352	198	32801	267	36237	239	36522	262	37685	245	39935	80
31578	290	32353	198	32802	267	36238	239	36524	262	37687	245	39936	80
31580	290	32354	198	32803	267	36243	237	36525	260	37688	245	39937	80
31582	290	32355	198	32804	267	36244	237	36526	262	37701	232	39938	80
31584	290	32356	198	32805	267	36245	237	36527	260	37702	232	39939	80
31586	290	32357	198	32806	268	36246	237	36530	264	37703	232	39940	80
31590	291	32358	198	32807	268	36247	237	36540	264	37704	232	39941	76
31592	291	32360	195	32808	268	36248	237	36550	264	37705	232	39942	80
31594	291	32361	195	32809	268	36249	237	36562	264	37706	232	39943	76
31596	291	32362	195	32810	268	36250	237	36611	203	37707	232	39944	80
31598	291	32363	195	32811	268	36251	243	36612	203	37708	232	39946	93
31600	291	32364	195	32812	268	36252	237	36696	239	38005	257	39947	93
31602	291	32365	195	32815	268	36253	234	36700	239	38010	257	39948	93
31604	291	32366	195	32816	268	36255	234	36704	243	38015	257	39949	93

# Appendix

## Reference list

Order No.	Page	Order No.	Page	Order No.	Page	Order No.	Page	Order No.	Page	Order No.	Page	Order No.	Page
39950	93	41304	76	42011	331	42332	48	42580	118	42883	85	43451	166
39952	96	41305	76	42012	331	42333	49	42582	118	42885	85	43452	166
39953	92	41306	76	42013	331	42334	49	42583	118	42887	85	43453	166
39954	92	41307	76	42014	331	42336	49	42584	118	42889	85	43460	164
39955	92	41308	76	42015	330	42350	57	42585	118	42891	85	43461	164
39956	92	41309	76	42016	330	42360	57	42586	118	42893	85	43462	164
39957	92	41310	76	42017	332	42370	56	42596	125	42895	85	43463	164
39961	95	41311	76	42023	331	42371	56	42597	125	42897	85	43464	164
39962	92	41312	76	42024	330	42376	56	42598	125	42899	85	43465	164
39963	92	41313	76	42025	331	42379	56	42599	125	42900	85	43466	165
39964	92	41314	76	42026	331	42382	56	42600	125	42901	85	43467	165
39965	94	41315	76	42027	331	42385	56	42601	128	42903	85	43468	165
39966	92	41316	77	42028	331	42388	56	42602	127	42905	85	43469	165
39967	97	41317	77	42029	331	42391	56	42604	124	42906	85	43470	165
39968	98	41318	77	42030	331	42394	56	42605	124	42908	85	43480	181
39969	98	41319	77	42031	331	42397	56	42606	124	42909	85	43481	181
39970	98	41320	77	42032	331	42398	56	42607	124	42920	313	43482	181
39971	98	41321	77	42033	331	42410	106	42608	126	42922	313	43483	181
39972	98	41322	77	42038	55	42412	106	42609	124	42923	313	43490	181
39977	97	41323	77	42039	55	42413	106	42611	129	42924	313	43491	181
39978	97	41324	77	42040	55	42418	106	42614	185	42941	313	43492	181
39979	97	41325	77	42042	55	42420	106	42616	185	42943	313	43493	181
39980	97	41326	77	42044	55	42421	107	42620	330	42945	313	43508	163
39981	96	41327	77	42046	55	42422	107	42630	184	42952	313	43510	163
39982	97	41328	77	42048	331	42423	107	42631	184	42953	313	43511	163
39983	98	41329	77	42049	331	42424	107	42633	331	42954	313	43512	163
41200	80	41330	77	42050	331	42425	106	42642	129	42955	313	43514	163
41201	80	41331	77	42051	331	42426	106	42643	129	42956	313	43515	163
41202	80	41332	77	42060	53	42427	106	42644	130	42957	313	43516	163
41203	76	41333	77	42061	53	42434	106	42645	130	42958	313	43518	163
41204	76	41334	77	42062	53	42435	107	42646	130	42959	313	43519	163
41205	76	41351	76	42063	53	42460	51	42647	130	43070	307	43520	163
41206	76	41352	77	42140	36	42461	51	42648	129	43071	307	43521	163
41207	76	41353	77	42141	36	42501	118	42649	129	43072	307	43522	163
41208	76	41360	81	42143	36	42502	118	42650	129	43073	307	43523	163
41209	76	41361	81	42144	36	42503	118	42651	129	43074	307	43524	163
41210	76	41362	81	42145	36	42504	118	42652	183	43075	307	43525	163
41211	76	41363	77	42147	37	42505	118	42653	183	43076	307	43526	163
41212	76	41364	77	42148	37	42506	118	42654	183	43077	307	43527	163
41213	76	41365	77	42149	37	42507	118	42655	183	43078	307	43528	163
41214	76	41410	38	42162	30	42508	118	42656	183	43079	307	43531	169
41215	76	41415	38	42164	30	42509	118	42657	183	43080	307	43532	169
41216	77	41420	38	42165	30	42510	118	42658	183	43081	307	43533	169
41217	77	41425	38	42168	30	42511	118	42805	171	43082	307	43534	169
41218	77	41430	38	42204	31	42512	118	42806	171	43083	307	43535	169
41219	77	41432	83	42206	31	42513	118	42807	171	43084	307	43536	170
41220	77	41434	83	42207	33	42514	118	42808	171	43250	311	43537	170
41221	77	41436	83	42208	33	42515	119	42809	171	43251	311	43538	170
41222	77	41438	83	42209	33	42516	119	42810	171	43252	311	43550	170
41223	77	41440	83	42212	31	42517	119	42811	171	43253	311	43551	170
41224	77	41460	83	42216	31	42518	119	42812	171	43254	311	43552	170
41225	77	41465	83	42221	34	42519	119	42813	171	43255	311	43553	170
41226	77	41470	83	42222	34	42520	119	42814	171	43300	319	43554	170
41227	77	41475	83	42223	35	42521	119	42815	171	43302	319	43555	170
41228	77	41480	83	42224	34	42540	118	42816	171	43304	319	43556	170
41229	77	41485	82	42225	34	42545	119	42817	171	43306	319	43560	169
41230	77	41490	82	42226	35	42550	120	42818	171	43308	319	43561	170
41231	77	41500	84	42227	35	42551	120	42819	171	43310	319	43562	170
41232	77	41510	84	42232	34	42552	120	42820	171	43312	319	43563	170
41233	77	41520	84	42233	35	42556	120	42821	171	43314	319	43564	170
41234	77	41530	84	42234	35	42557	120	42822	171	43316	319	43565	170
41251	76	41540	84	42241	39	42558	120	42823	171	43318	319	43566	170
41252	77	41550	84	42244	39	42559	120	42824	171	43320	319	43567	170
41253	77	41552	84	42247	39	42560	120	42825	171	43322	319	43568	170
41257	80	41991	331	42248	39	42566	118	42826	171	43324	319	43569	170
41258	80	41992	331	42249	23	42568	118	42827	171	43334	317	43570	170
41260	81	41994	331	42250	23	42570	118	42828	171	43340	317	43572	169
41261	81	41995	331	42258	23	42571	118	42829	171	43346	317	43573	169
41262	80	41996	331	42259	23	42572	118	42830	171	43352	317	43574	169
41263	77	42003	332	42261	23	42573	118	42831	171	43412	115	43575	169
41264	77	42004	332	42320	47	42574	118	42823	171	43413	115	43576	167
41265	77	42007	332	42322	47	42575	118	42834	171	43414	115	43578	167
41302	76	42008	332	42324	47	42576	118	42877	85	43415	115	43581	167
41303	76	42010	330	42330	48	42578	118	42881	85	43450	166	43583	167

# Appendix

## Reference list

Order No.	Page	Order No.	Page	Order No.	Page	Order No.	Page	Order No.	Page	Order No.	Page	Order No.	Page
43585	167	43834	325	44307	305	45404	66	48250	19	50756	157	56001	136
43587	167	43836	327	44308	305	45406	66	48258	19	50758	157	56002	136
43591	167	43838	327	44309	305	45414	66	48259	19	50760	157	56003	136
43592	169	43840	327	44310	305	45416	66	48300	343	50761	157	56004	136
43593	169	43842	327	44311	305	45424	66	48301	343	50762	157	56005	136
43594	169	43846	327	44400	313	45426	66	49056	33	50763	157	56006	136
43595	169	43848	327	44401	313	45450	61	50508	163	50780	155	56020	137
43596	169	43852	325	44402	313	45452	61	50510	163	50790	155	56021	137
43597	169	43853	325	44403	313	45454	61	50511	163	50794	154	56021	137
43598	169	43854	325	44404	313	45455	61	50512	163	50796	154	56100	136
43599	169	43855	325	44405	313	45456	61	50514	163	50798	154	56101	136
43622	115	43856	325	44406	313	45692	110	50515	163	50930	147	56102	136
43626	115	43861	327	44407	313	45695	110	50516	163	50932	146	56103	136
43632	115	43865	329	44408	313	45702	110	50518	163	50934	147	56104	136
43636	115	43866	329	44409	313	45711	110	50519	163	50936	146	56105	136
43642	114	43871	323	44410	313	45715	110	50520	163	50938	147	56106	136
43643	114	43882	314	44411	313	45722	110	50521	163	50940	146	56120	137
43644	114	43883	314	44500	301	45726	111	50522	163	50942	147	56121	137
43645	114	43886	314	44501	301	45728	111	50523	163	50944	146	56122	137
43655	114	43887	314	44502	301	45730	111	50524	163	51500	369	58000	365
43656	114	43888	314	44503	301	45732	111	50525	163	51501	369	58006	365
43658	114	43889	314	44504	301	45734	111	50526	163	51505	354	58012	365
43659	114	43890	314	44505	301	45736	111	50527	163	51510	354	58018	365
43660	114	43891	314	44506	301	45738	111	50528	163	51515	354	61002	214
43682	173	43894	314	44507	301	45740	111	50531	169	51520	355	61003	214
43683	173	43896	314	44508	301	46100	41	50532	169	51521	355	61004	214
43684	173	43899	314	44509	301	46105	41	50533	169	51522	355	61005	214
43685	173	43901	321	44510	301	46110	41	50550	170	51538	355	61011	215
43686	173	43902	321	44511	301	46115	41	50551	170	51540	355	61012	215
43700	149	43903	321	44512	303	46120	41	50552	170	52272	346	61013	215
43705	149	43904	321	44513	303	46125	41	50553	170	52273	346	61014	215
43710	149	43905	323	44514	303	46130	41	50554	170	52274	346	61018	214
43711	149	43906	323	44515	303	46135	41	50555	170	52275	346	61019	214
43715	150	43907	323	44520	309	46140	41	50556	170	52276	346	61021	215
43720	149	43908	323	44521	309	46145	41	50560	169	52277	346	61022	215
43725	149	43909	323	44522	309	46150	41	50562	170	52278	346	61023	215
43730	150	43910	323	44523	309	46155	41	50564	170	52283	346	61024	215
43732	157	43930	147	44524	309	46201	40	50566	170	52284	346	61025	215
43733	157	43932	146	44525	309	46202	40	50567	170	52285	346	61026	215
43734	157	43934	147	44526	309	46203	40	50568	170	52286	346	61027	215
43735	150	43936	146	45024	62	46204	40	50569	170	52287	346	61028	215
43736	157	43938	147	45025	62	46210	40	50570	170	52288	346	61030	204
43737	157	43940	146	45026	62	46211	40	50576	167	52289	346	61031	204
43741	157	43942	147	45027	62	46212	40	50578	167	52290	346	61032	204
43750	157	43944	146	45028	63	46214	40	50581	167	52300	337	61033	204
43751	157	44050	159	45029	63	46215	40	50583	167	52301	337	61045	205
43752	157	44051	159	45030	63	46250	40	50585	167	52302	337	61046	205
43756	157	44052	159	45031	63	46251	40	50587	167	52305	338	61047	205
43758	157	44053	159	45034	62	46252	40	50591	167	52307	338	61048	206
43760	157	44054	159	45035	62	46255	40	50652	183	52308	338	61049	206
43761	157	44055	159	45036	62	46256	40	50653	183	52310	337	61050	206
43762	157	44056	159	45037	62	46300	40	50654	183	52311	337	61051	206
43763	157	44057	159	45105	346	46330	40	50655	183	52312	337	61052	206
43780	155	44058	159	45106	346	46500	161	50656	183	52313	337	61053	206
43790	155	44059	159	45107	346	46501	161	50657	183	52314	337	61054	207
43794	154	44060	159	45108	346	46502	161	50658	183	52315	337	61055	207
43796	154	44061	159	45109	346	46503	161	50700	149	52350	339	61056	207
43798	154	44062	159	45110	346	46504	161	50705	149	52351	339	61057	207
43800	152	44063	159	45112	63	47200	39	50710	149	52352	339	61058	207
43801	152	44064	159	45115	63	47220	39	50711	149	54162	21	61059	207
43802	152	44100	367	45130	65	47240	39	50715	150	54165	21	61061	208
43803	152	44101	367	45134	65	47250	39	50720	149	54168	21	61061.9005	208
43804	152	44102	367	45152	65	47255	39	50725	149	54204	22	61062	208
43809	153	44103	367	45154	65	48162	17	50730	150	54206	22	61062.9005	208
43811	153	44104	367	45203	63	48165	17	50732	157	54212	22	61063	208
43812	153	44105	367	45204	63	48168	17	50733	157	54216	22	61063.9005	208
43813	153	44106	367	45205	63	48204	18	50734	157	54241	21	61065	208
43814	153	44300	305	45206	63	48206	18	50735	150	54244	21	61065.9005	208
43815	151	44301	305	45212	63	48212	18	50736	157	54247	21	61066	208
43816	151	44302	305	45215	63	48216	18	50737	157	54300	71	61066.9005	208
43817	151	44303	305	45236	64	48241	17	50741	157	54301	71	61067	208
43818	151	44304	305	45237	64	48244	17	50750	157	54302	71	61067.9005	208
43819	151	44305	305	45238	64	48247	17	50751	157	54303	71	61068	210
43832	329	44306	305	45239	64	48249	19	50752	157	56000	136	61068.9005	210

# Appendix

## Reference list

Order No.	Page	Order No.	Page	Order No.	Page	Order No.	Page	Order No.	Page	Order No.	Page	Order No.	Page
61069	210	73944	427	80208	390	91070	444	99491	281	36780.02	249	36784.31	249
61069.9005	210	80000	375	80209	390	98047	275	99495	281	36780.03	249	36784.32	249
61070	210	80002	376	80210	390	99142	86	99496	281	36780.04	249	36784.33	249
61070.9005	210	80003	375	80211	390	99152	357	99497	281	36780.10	249	36784.34	249
61071	210	80005	375	80213	390	99153	355	99498	281	36780.11	249	36784.40	249
61071.9005	210	80006	375	80214	390	99190	100	99500	280	36780.12	249	36784.41	249
61073	211	80007	384	80217	390	99195	125	99501	280	36780.13	249	36784.42	249
61073.9005	211	80008	384	80218	390	99196	125	99502	280	36780.14	249	36784.43	249
61074	211	80020	384	80219	390	99197	125	99503	280	36780.20	249	36785.01	248
61074.9005	211	80021	384	80221	384	99200	174	99504	280	36780.21	249	36785.02	248
61076	210	80022	384	80225	382	99201	174	99505	280	36780.22	249	36785.03	248
61076.9005	210	80023	384	80226	390	99215	193	99506	280	36780.23	249	36785.04	248
61077	210	80024	384	80228	390	99216	193	99507	280	36780.24	249	36785.10	248
61077.9005	210	80025	384	80229	390	99217	193	99555	279	36780.30	249	36785.11	248
61078	210	80026	384	80230	390	99218	193	99556	279	36780.31	249	36785.12	248
61078.9005	210	80027	384	80231	390	99219	193	99557	279	36780.32	249	36785.13	248
61080	211	80028	384	80232	390	99300	395	99558	279	36780.33	249	36785.14	248
61080.9005	211	80029	384	80234	390	99301	395	32695.01	231	36780.34	249	36785.20	248
61081	211	80030	384	81100	443	99302	395	32695.011	231	36780.40	249	36785.21	248
61081.6005	211	80031	386	81101	443	99303	395	32695.02	231	36780.41	249	36785.22	248
61082	211	80032	386	81102	443	99305	395	32707.01	231	36780.42	249	36785.23	248
61082.9005	211	80034	384	81103	443	99306	395	32707.011	231	36780.43	249	36785.24	248
61430	391	80049	378	81104	443	99307	395	32707.02	231	36781.01	248	36785.30	248
61435	391	80050	378	81105	443	99308	395	32707.021	231	36781.02	248	36785.31	248
61436	391	80051	378	81133	445	99309	395	36222.002	234	36781.03	248	36785.32	248
61437	391	80052	378	81134	445	99311	395	36224.002	234	36781.04	248	36785.33	248
70000.200	419	80053	378	81135	445	99312	395	36235.002	239	36781.10	248	36785.34	248
70001.200	419	80054	378	81200	443	99314	395	36236.002	239	36781.11	248	36785.40	248
70002.200	419	80055	378	81202	443	99315	395	36251.100	243	36781.12	248	36785.41	248
70003.200	419	80056	378	81203	443	99400	277	36253.100	243	36781.13	248	36785.42	248
70004.200	419	80057	378	81232	445	99401	277	36255.100	243	36781.14	248	36785.43	248
70005.200	419	80058	378	81233	445	99402	277	36256.100	243	36781.20	248	36786.1	239
70006.200	420	80059	380	81300	440	99410	275	36257.100	243	36781.21	248	36786.2	239
70007.200	420	80060	380	81301	440	99411	275	36258.100	243	36781.22	248	36786.3	239
70008.200	420	80061	378	81302	440	99412	275	36259.100	243	36781.23	248	36786.4	239
70009.200	420	80062	378	81303	440	99420	277	36296.2	230	36781.24	248	36786.5	239
70010.200	421	80063	380	81304	440	99422	277	36296.2	230	36781.30	248	36786.6	239
70011.200	421	80064	380	81305	440	99431	279	36297.1	230	36781.31	248	36787.1	238
70012.200	421	80065	380	81306	440	99432	279	36297.2	230	36781.32	248	36787.151	238
70013.200	421	80068	384	81307	440	99434	279	36297.3	230	36781.33	248	36787.152	238
70351	429	80069	386	81308	440	99435	279	36297.4	230	36781.34	248	36787.153	238
70352	429	80070	384	81309	440	99436	279	36297.5	230	36781.40	248	36787.154	238
70353	429	80071	386	81330	444	99437	279	36298.1	230	36781.41	248	36787.155	238
70354	429	80072	375	81331	444	99459	280	36298.2	230	36781.42	248	36787.156	238
70355	429	80075	378	81332	444	99460	280	36301.2	230	36781.43	248	36787.2	238
70356	429	80101	378	81333	445	99461	280	36302.2	230	36782.1	247	36787.3	238
70357	429	80120	388	81334	445	99462	280	36303.2	230	36782.2	247	36787.4	238
70358	429	80121	388	81337	445	99463	280	36500.002	237	36782.3	247	36787.5	238
70359	429	80122	388	81400	439	99464	280	36502.002	237	36782.4	247	36787.6	238
70360	429	80123	388	81401	439	99465	280	36650.1	250	36782.5	247	36788.01	241
70361	429	80124	388	81402	439	99466	280	36650.2	250	36782.6	247	36788.02	241
70362	429	80125	388	81403	439	99467	280	36650.3	250	36782.7	247	36788.03	241
70500	430	80126	388	81404	439	99468	280	36650.4	250	36783.1	246	36788.04	241
70501	430	80128	388	81430	444	99469	280	36653.1	250	36783.2	246	36788.10	241
70502	430	80148	382	81431	444	99470	280	36656.1	250	36783.3	246	36788.11	241
70503	430	80149	382	81432	444	99471	280	36656.2	250	36783.4	246	36788.12	241
70504	430	80150	382	81500	437	99472	280	36656.3	250	36783.5	246	36788.13	241
70620	430	80151	382	81501	437	99473	280	36696.002	243	36783.6	246	36788.14	241
70621	430	80152	382	81502	437	99475	281	36700.002	243	36783.7	246	36788.20	241
70622	430	80153	382	81503	437	99476	281	36778.1	247	36784.01	249	36788.21	241
70623	430	80154	382	81504	437	99477	281	36778.2	247	36784.02	249	36788.22	241
70624	430	80155	386	81530	437	99478	281	36778.3	247	36784.03	249	36788.23	241
70680	431	80156	386	81531	437	99479	281	36778.4	247	36784.04	249	36788.24	241
70681	431	80157	384	88001	87	99480	281	36778.5	247	36784.10	249	36788.30	241
70682	431	80158	386	88002	255	99481	281	36778.6	247	36784.11	249	36788.31	241
70683	431	80160	384	88005	121	99482	281	36778.7	247	36784.12	249	36788.32	241
70710	431	80189	376	88006	254	99483	281	36779.1	246	36784.13	249	36788.33	241
73930	427	80190	376	88031	212	99484	281	36779.2	246	36784.14	249	36788.34	241
73932	427	80200	384	88032	212	99485	281	36779.3	246	36784.20	249	36788.40	241
73934	427	80201	384	88033	212	99486	281	36779.4	246	36784.21	249	36788.41	241
73936	427	80204	390	88034	213	99487	281	36779.5	246	36784.22	249	36788.42	241
73938	427	80205	378	88035	213	99488	281	36779.6	246	36784.23	249	36788.43	241
73940	427	80206	390	88036	213	99489	281	36779.7	246	36784.24	249	36789.01	240
73942	427	80207	390	88037	213	99490	281	36780.01	249	36784.30	249	36789.02	240



# Appendix

## Reference list

Order No.	Page	Order No.	Page	Order No.	Page	Order No.	Page	Order No.	Page	Order No.	Page	Order No.	Page
36789.03	240	37505.30	252	38075.100	256	41215.601	404	42204.400	31	43700.400	149	43801.400	152
36789.04	240	37505.31	252	38076.002	256	41216.600	406	42206.200	31	43700.600	407	43802.400	152
36789.10	240	37505.32	252	38076.100	256	41216.601	406	42206.400	31	43700.601	407	43803.400	152
36789.11	240	37505.33	252	38077.002	256	41217.600	406	42207.200	33	43705.400	149	43804.400	152
36789.12	240	37507.01	253	38077.100	256	41217.601	406	42207.400	33	43705.600	407	43809.600	408
36789.13	240	37507.02	253	38078.002	256	41218.600	406	42208.200	33	43705.601	407	43809.601	408
36789.14	240	37507.03	253	38078.100	256	41218.601	406	42208.400	33	43710.400	149	43811.600	408
36789.20	240	37507.10	253	38079.002	256	41219.600	406	42209.200	33	43710.600	407	43811.601	408
36789.21	240	37507.11	253	38079.100	256	41219.601	406	42209.400	33	43710.601	407	43812.600	408
36789.22	240	37507.12	253	39710.01	231	41220.600	406	42212.200	31	43711.400	149	43812.601	408
36789.23	240	37507.13	253	39710.011	231	41220.601	406	42212.400	31	43711.600	407	43813.600	408
36789.24	240	37507.20	253	39710.02	231	41221.600	406	42216.200	31	43711.601	407	43813.601	408
36789.30	240	37507.21	253	39710.021	231	41221.601	406	42216.400	31	43715.400	150	43814.600	408
36789.31	240	37507.22	253	39711.01	231	41222.600	406	42221.200	34	43715.600	407	43814.601	408
36789.32	240	37507.23	253	39711.011	231	41222.601	406	42221.400	34	43715.601	407	43815.400	151
36789.33	240	37507.30	253	39711.02	231	41223.600	406	42222.200	34	43720.400	149	43815.600	408
36789.34	240	37507.31	253	39711.021	231	41223.601	406	42222.400	34	43720.600	407	43815.601	408
36789.40	240	37507.32	253	39900.600	405	41224.600	406	42223.200	35	43720.601	407	43816.400	151
36789.41	240	37507.33	253	39900.601	405	41224.601	406	42223.400	35	43725.400	149	43816.600	408
36789.42	240	37510.1	252	39901.600	405	41225.600	406	42224.200	34	43725.600	407	43816.601	408
36789.43	240	37510.2	252	39901.601	405	41225.601	406	42224.400	34	43725.601	407	43817.400	151
36850.150	236	37510.3	252	39906.600	406	41226.600	406	42225.200	34	43730.400	150	43817.600	408
36855.150	236	37512.1	253	39906.601	405	41226.601	406	42225.400	34	43730.600	407	43817.601	408
36860.150	236	37512.2	253	39908.600	405	41227.600	406	42226.200	35	43730.601	407	43818.400	151
36865.150	236	37512.3	253	39908.601	405	41227.601	406	42226.400	35	43732.600	410	43818.600	408
36870.150	236	37514.1	253	39909.600	405	41228.600	406	42227.200	35	43732.601	410	43818.601	408
36875.150	236	37514.2	253	39909.601	405	41228.601	406	42227.400	35	43733.600	410	43819.400	151
36880.150	236	37514.3	253	39914.600	405	41229.600	406	42232.200	34	43733.601	410	43819.600	408
36886.1	233	37590.150	233	39914.601	405	41229.601	406	42232.400	34	43734.600	410	43819.601	408
36886.2	233	37591.150	233	39917.600	405	41230.600	406	42233.200	35	43734.601	410	43930.400	147
36886.3	233	37594.150	242	39917.601	405	41230.601	406	42233.400	35	43735.400	150	43932.400	147
36886.4	233	37595.150	242	39932.600	405	41231.600	406	42234.200	35	43735.600	407	43934.400	147
36886.5	233	37608.100	242	39932.601	405	41231.601	406	42234.400	35	43735.601	407	43936.400	146
36887.1	233	37610.100	242	39934.600	404	41232.600	406	42241.200	29	43736.600	410	43938.400	147
36887.2	233	37612.100	242	39934.601	404	41232.601	406	42241.400	29	43736.601	410	43940.400	146
36887.3	233	37612.150	242	39935.600	405	41233.600	406	42244.200	29	43737.600	410	43942.400	147
36887.4	233	37614.100	242	39935.601	405	41233.601	406	42244.400	29	43737.601	410	43944.400	146
36887.5	233	37614.150	242	39937.600	405	41234.600	406	42247.200	29	43741.600	410	47200.200	39
36910.100	242	37620.150	236	39937.601	405	41234.601	406	42247.400	29	43741.601	410	47220.200	39
36915.100	242	37622.150	236	39939.600	405	41251.600	404	42248.200	29	43750.600	410	47240.200	39
36920.100	242	37630.150	238	39939.601	405	41251.601	404	42248.400	29	43750.601	410	47250.200	39
36925.100	242	37632.150	238	39941.600	404	41252.600	406	42249.200	23	43751.600	410	47255.200	39
36930.100	242	37660.1	233	39941.601	404	41252.601	406	42249.400	23	43751.601	410	48162.200	17
36935.100	242	37660.2	233	39942.601	405	41253.600	406	42250.200	23	43752.600	410	48162.400	17
36940.100	242	37661.1	233	41200.600	405	41253.601	406	42250.400	23	43752.601	410	48162.600	402
36941.100	242	37661.2	233	41200.601	405	42010.002	330	42258.200	23	43756.600	410	48162.601	402
36948.3	233	37665.150	233	41201.600	405	42015.002	330	42258.400	23	43756.601	410	48165.200	17
37180.1	263	37666.150	233	41201.601	405	42016.002	330	42259.200	23	43758.600	410	48165.400	17
37180.2	263	37670.100	244	41202.601	405	42024.002	330	42259.400	23	43758.601	410	48165.600	402
37180.3	263	37671.100	244	41203.600	404	42140.200	36	42261.200	23	43760.600	410	48165.601	402
37180.4	263	37672.100	244	41203.601	404	42140.400	36	42320.200	47	43760.601	410	48168.200	17
37181.1	263	37673.100	244	41204.600	404	42141.200	36	42320.400	47	43761.600	410	48168.400	17
37181.2	263	38005.100	257	41204.601	404	42141.400	36	42322.200	47	43761.601	410	48168.600	402
37181.3	263	38010.100	257	41205.600	404	42143.200	36	42322.400	47	43762.600	410	48168.601	402
37181.4	263	38015.100	257	41205.601	404	42143.400	36	42324.200	47	43762.601	410	48204.200	18
37187.1	263	38020.100	257	41206.600	404	42144.200	36	42324.400	47	43763.600	410	48204.400	18
37187.2	263	38025.100	257	41206.601	404	42144.400	36	42330.200	48	43763.601	410	48204.600	402
37187.3	263	38030.100	257	41207.600	404	42145.200	36	42330.400	48	43780.400	155	48204.601	402
37187.4	263	38035.100	257	41207.601	404	42145.400	36	42332.200	48	43780.600	409	48206.200	18
37190.1	263	38040.100	257	41208.600	404	42147.200	37	42332.400	48	43780.601	409	48206.400	18
37190.2	263	38045.100	257	41208.601	404	42147.400	37	42333.200	49	43790.400	155	48206.600	402
37190.3	263	38050.100	257	41209.600	404	42148.200	37	42333.400	49	43790.600	409	48206.601	402
37190.4	263	38069.002	256	41209.601	404	42148.400	37	42334.200	49	43790.601	409	48212.200	18
37505.01	252	38070.002	256	41210.600	404	42149.200	37	42334.400	49	43790.601	409	48212.400	18
37505.02	252	38070.100	256	41210.601	404	42149.400	37	42336.200	49	43794.400	154	48212.600	402
37505.03	252	38071.002	256	41211.600	404	42162.200	30	42336.400	49	43794.600	409	48212.601	402
37505.10	252	38071.100	256	41211.601	404	42162.400	30	42350.200	57	43794.601	409	48216.200	18
37505.11	252	38072.002	256	41212.600	404	42164.200	30	42360.200	57	43796.400	154	48216.400	18
37505.12	252	38072.100	256	41212.601	404	42164.400	30	43675.001	173	43796.600	409	48216.600	402
37505.13	252	38073.002	256	41213.600	404	42165.200	30	43675.001.600	409	43796.601	409	48216.601	402
37505.20	252	38073.100	256	41213.601	404	42165.400	30	43675.001.601	409	43798.400	154	48.241.200	17
37505.21	252	38074.002	256	41214.600	404	42168.200	30	43675.101	173	43798.600	409	48241.400	17
37505.22	252	38074.100	256	41214.601	404	42168.400	30	43675.101.600	409	43798.601	409	48241.600	402
37505.23	252	38075.002	256	41215.600	404	42204.200	31	43675.101.601	409	43800.400	152	48241.601	402

# Appendix

## Reference list

Order No.	Page	Order No.	Page	Order No.	Page	Order No.	Page	Order No.	Page
48244.200	17	50760.600	410	58210.0397	357	70357.601	411	99306.204	394
48244.400	17	50760.601	410	58210.0414	359	70358.600	411	99307.001	394
48244.600	402	50761.600	410	58210.0435	357	70358.601	411	99307.002	394
48244.601	402	50761.601	410	58210.0477	359	70359.600	411	99307.201	394
48247.200	17	50762.600	410	58210.0495	357	70359.601	411	99307.202	394
48247.400	17	50762.601	410	58210.0562	357	70360.600	411	99308.001	394
48247.600	402	50763.600	410	58210.0592	358	70360.601	411	99308.002	394
48247.601	402	50763.601	410	58210.0614	359	70361.600	411	99308.201	394
48249.200	19	50780.400	155	58210.0635	357	70361.601	411	99308.202	394
48249.400	19	50780.600	409	58210.0762	357	70362.600	411	99309.001	394
48249.600	402	50780.601	409	58210.0792	358	70362.601	411	99309.002	394
48249.601	402	50790.400	155	58210.0814	359	99300.001	394	99309.201	394
48250.200	19	50790.600	409	58210.0835	357	99300.002	394	99309.202	394
48250.400	19	50794.400	155	58210.0992	358	99300.003	394		
48250.600	402	50794.600	409	58215.0392	358	99300.004	394		
48250.601	402	50794.601	409	58215.0414	359	99300.005	394		
48258.200	19	50796.400	154	58215.0477	359	99300.006	394		
48258.400	19	50796.600	409	58215.0592	358	99300.010	395		
48258.600	402	50796.601	409	58215.0614	359	99300.011	395		
48258.601	402	50798.400	154	58215.0792	358	99300.012	395		
48259.200	19	50798.600	409	58215.0992	358	99300.013	395		
48259.400	19	50930.400	147	58221.0345	361	99300.014	395		
48259.600	402	50932.400	146	58221.0363	361	99300.015	395		
48259.601	402	50934.400	147	58221.0435	360	99300.016	395		
49056.200	33	50936.400	146	58221.0445	361	99300.017	395		
49056.400	33	50938.400	147	58221.0495	360	99300.018	395		
50700.400	149	50940.400	146	58221.0835	360	99300.019	395		
50700.600	407	50942.400	147	58222.0345	361	99300.020	395		
50700.601	407	50944.400	147	58222.0363	361	99300.021	395		
50705.400	149	51520.002	355	58222.0435	360	99300.022	395		
50705.600	407	51521.002	355	58222.0445	361	99300.023	395		
50705.601	407	51522.002	355	58222.0495	360	99300.024	395		
50710.400	149	54162.200	21	58222.0563	361	99300.201	394		
50710.600	407	54162.400	21	58222.0635	360	99300.202	394		
50710.601	407	54162.600	403	58222.0835	360	99300.203	394		
50711.400	149	54162.601	403	58225.0402	357	99300.204	394		
50711.600	407	54165.200	21	58225.0452	357	99300.205	394		
50711.601	407	54165.400	21	58225.0502	357	99300.206	394		
50715.400	150	54165.600	403	58225.0652	357	99301.001	394		
50715.600	407	54165.601	403	58230.0402	357	99301.002	394		
50715.601	407	54168.200	21	58230.0452	357	99301.003	394		
50720.400	149	54168.400	21	58230.0502	357	99301.004	394		
50720.600	407	54168.600	403	58230.0652	357	99301.005	394		
50720.601	407	54168.601	403	61030.9005	204	99301.006	394		
50725.400	147	54204.200	22	61031.9005	204	99301.007	395		
50725.600	407	54204.400	22	61032.9005	204	99301.008	395		
50725.601	407	54204.600	403	61033.9005	204	99301.009	395		
50730.400	151	54204.601	403	61045.9005	205	99301.010	395		
50730.600	407	54206.200	22	61046.9005	205	99301.011	395		
50730.601	407	54206.400	22	61047.9005	205	99301.201	394		
50732.601	410	54206.600	403	61048.9005	206	99301.202	394		
50733.600	410	54206.601	403	61049.9005	206	99301.203	394		
50733.601	410	54212.200	22	61050.9005	206	99301.204	394		
50734.600	410	54212.400	22	61051.9005	206	99301.205	394		
50734.601	410	54212.600	403	61052.9005	206	99301.206	394		
50735.400	150	54212.601	403	61053.9005	206	99302.001	394		
50735.600	407	54216.200	22	61054.9005	207	99302.002	394		
50735.601	407	54216.400	22	61055.9005	207	99302.201	394		
50736.600	410	54216.600	403	61056.9005	207	99302.202	394		
50736.601	410	54216.601	403	61057.9005	207	99305.001	394		
50737.600	410	54241.200	21	61058.9005	207	99305.002	394		
50737.601	410	54241.400	21	70351.600	411	99305.003	394		
50741.600	410	54241.600	403	70351.601	411	99305.004	394		
50741.601	410	54241.601	403	70352.600	411	99305.201	394		
50750.600	410	54244.200	21	70352.601	411	99305.202	394		
50750.601	410	54244.400	21	70353.600	411	99305.203	394		
50751.600	410	54244.600	403	70353.601	411	99305.204	394		
50751.601	410	54244.601	403	70354.600	411	99306.001	394		
50752.600	410	54247.200	21	70354.601	411	99306.002	394		
50752.601	410	54247.400	21	70355.600	411	99306.003	394		
50756.600	410	54247.600	403	70355.601	411	99306.004	394		
50756.601	410	54247.601	403	70356.600	411	99306.201	394		
50758.600	410	58210.0362	357	70356.601	411	99306.202	394		
50758.601	410	58210.0392	358	70357.600	411	99306.203	394		

Grab your phone and follow us!

Follow icotek on

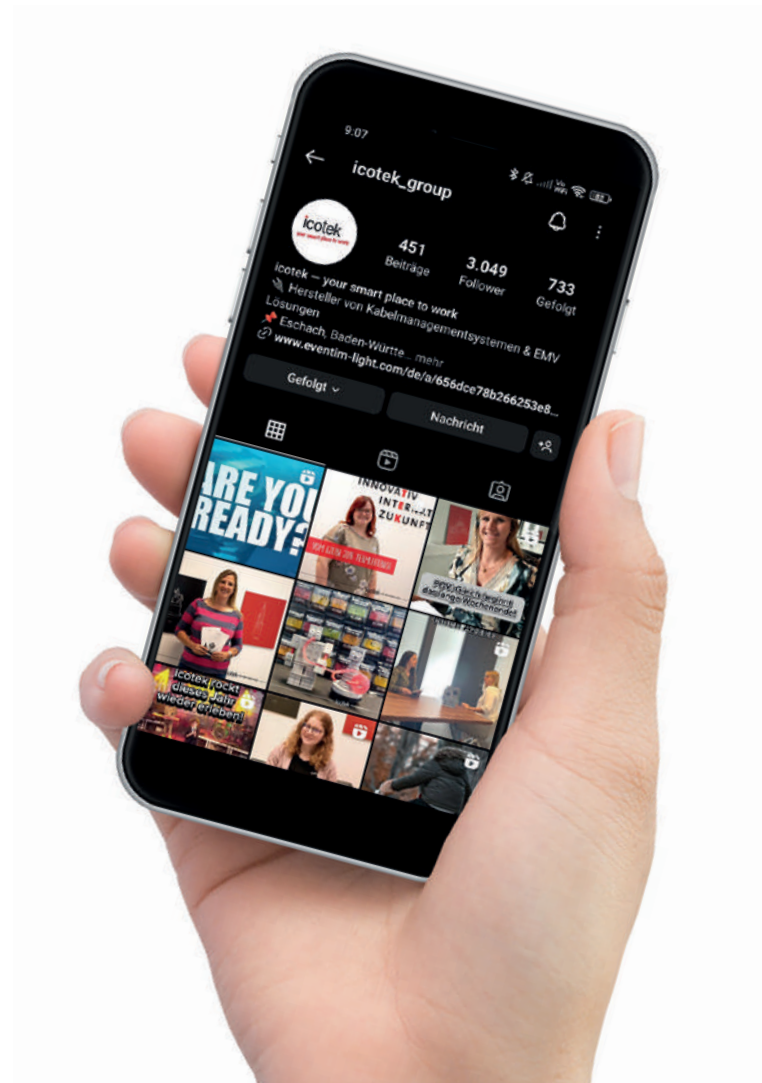



smart cable management

**icotek GmbH & Co. KG**

Bischof-von-Lipp-Straße 1  
73569 Eschach | Germany

Tel +49 7175 9 23 80-0

Fax +49 7175 9 23 80-50

info@icotek.com

www.icotek.com

**icotek (swiss) AG**

Wiesenstrasse 14  
9327 Tübach | Switzerland

Tel +41 71 858 23 23

Fax +41 71 858 23 24

info@icotek.ch

www.icotek.ch

**icotek SARL**

130, rue des terres Bourdin  
69140 Rillieux-la-Pape  
France

Tél +33 4 81 91 97 65

Fax +33 4 81 91 97 68

info@icotek.fr

www.icotek.fr

**icotek Italia s.r.l.**

Via Dante Alighieri, 26/28  
20029 Turbigo (MI) | Italia

Tel +39 0331 152 03 23

info@icotek-italia.it

www.icotek-italia.it

**icotek Iberia S.L.**

Carrer de la Ciència 19B  
08850 Gavà, Barcelona  
Espanya

Tel +34 666 449 978

info@icotek.es

www.icotek.es

**icotek Limited**

Unit C5,  
Broadoak Business Park  
Ashburton Road West,  
Trafford Park  
Manchester M17 1RW | UK

Phone +44 161 222 3454

info@icotek.co.uk

www.icotek.co.uk

**icotek Elektronik Tic. Ltd. Şti.**

Fevzi Çakmak Mah.,  
Bilginler Sok. No: 17/A-B  
34899 | Pendik, İstanbul  
Türkiye

Tel +90 216 396 59 59

info@icotek.com.tr

www.icotek.com.tr

**icotek Corp.**

3435 N Kimball Ave  
Chicago, IL 60618 | USA

Phone +1 312.643.2315

info@icotek-usa.com

www.icotek-usa.com

**icotek Cable Management  
Trading (Shanghai) Co. Ltd**

1<sup>st</sup>-2<sup>nd</sup> floor, Building 8,  
No. 188, Zhongchen Road,  
Songjiang District,  
Shanghai City, 201613

Tel +86 21 5767 6805

Fax +86 21 5765 9635

info@icotek.cn

www.icotek.cn

**icotek India Pvt Ltd**

No 14-b, 4th Cross Rd  
Veerasandra Industrial Area  
Phase 2, Electronic City  
Bengaluru, Karnataka 560100  
India

Phone +91 953 567 3112

info@icotek.in

www.icotek.in

